



# Fire Alarm Control Panel **NFS2-3030** Programming Manual

**NATURSONNE**



Pacheco 2060, CABA,  
Buenos Aires, Argentina  
Teléfono +54 11 4524-2655  
[www.natursonne.com.ar](http://www.natursonne.com.ar)

Document 52545  
07/18/2014

Rev: **N1**

P/N 52545-N1

ECN 13-0838

# Fire Alarm & Emergency Communication System Limitations

*While a life safety system may lower insurance rates, it is not a substitute for life and property insurance!*

**An automatic fire alarm system**—typically made up of smoke detectors, heat detectors, manual pull stations, audible warning devices, and a fire alarm control panel (FACP) with remote notification capability—can provide early warning of a developing fire. Such a system, however, does not assure protection against property damage or loss of life resulting from a fire.

**An emergency communication system**—typically made up of an automatic fire alarm system (as described above) and a life safety communication system that may include an autonomous control unit (ACU), local operating console (LOC), voice communication, and other various interoperable communication methods—can broadcast a mass notification message. Such a system, however, does not assure protection against property damage or loss of life resulting from a fire or life safety event.

The Manufacturer recommends that smoke and/or heat detectors be located throughout a protected premises following the recommendations of the current edition of the National Fire Protection Association Standard 72 (NFPA 72), manufacturer's recommendations, State and local codes, and the recommendations contained in the Guide for Proper Use of System Smoke Detectors, which is made available at no charge to all installing dealers. This document can be found at <http://www.systemsensor.com/appguides/>. A study by the Federal Emergency Management Agency (an agency of the United States government) indicated that smoke detectors may not go off in as many as 35% of all fires. While fire alarm systems are designed to provide early warning against fire, they do not guarantee warning or protection against fire. A fire alarm system may not provide timely or adequate warning, or simply may not function, for a variety of reasons:

**Smoke detectors** may not sense fire where smoke cannot reach the detectors such as in chimneys, in or behind walls, on roofs, or on the other side of closed doors. Smoke detectors also may not sense a fire on another level or floor of a building. A second-floor detector, for example, may not sense a first-floor or basement fire.

**Particles of combustion or "smoke"** from a developing fire may not reach the sensing chambers of smoke detectors because:

- Barriers such as closed or partially closed doors, walls, chimneys, even wet or humid areas may inhibit particle or smoke flow.
- Smoke particles may become "cold," stratify, and not reach the ceiling or upper walls where detectors are located.
- Smoke particles may be blown away from detectors by air outlets, such as air conditioning vents.
- Smoke particles may be drawn into air returns before reaching the detector.

The amount of "smoke" present may be insufficient to alarm smoke detectors. Smoke detectors are designed to alarm at various levels of smoke density. If such density levels are not created by a developing fire at the location of detectors, the detectors will not go into alarm.

Smoke detectors, even when working properly, have sensing limitations. Detectors that have photoelectronic sensing chambers tend to detect smoldering fires better than flaming fires, which have little visible smoke. Detectors that have ionizing-type sensing chambers tend to detect fast-flaming fires better than smoldering fires. Because fires develop in different ways and are often unpredictable in their growth, neither type of detector is necessarily best and a given type of detector may not provide adequate warning of a fire.

Smoke detectors cannot be expected to provide adequate warning of fires caused by arson, children playing with matches (especially in bedrooms), smoking in bed, and violent explosions

(caused by escaping gas, improper storage of flammable materials, etc.).

**Heat detectors** do not sense particles of combustion and alarm only when heat on their sensors increases at a predetermined rate or reaches a predetermined level. Rate-of-rise heat detectors may be subject to reduced sensitivity over time. For this reason, the rate-of-rise feature of each detector should be tested at least once per year by a qualified fire protection specialist. Heat detectors are designed to protect property, not life.

**IMPORTANT! Smoke detectors** must be installed in the same room as the control panel and in rooms used by the system for the connection of alarm transmission wiring, communications, signaling, and/or power. If detectors are not so located, a developing fire may damage the alarm system, compromising its ability to report a fire.

**Audible warning devices such as bells, horns, strobes, speakers and displays** may not alert people if these devices are located on the other side of closed or partly open doors or are located on another floor of a building. Any warning device may fail to alert people with a disability or those who have recently consumed drugs, alcohol, or medication. Please note that:

- An emergency communication system may take priority over a fire alarm system in the event of a life safety emergency.
- Voice messaging systems must be designed to meet intelligibility requirements as defined by NFPA, local codes, and Authorities Having Jurisdiction (AHJ).
- Language and instructional requirements must be clearly disseminated on any local displays.
- Strobes can, under certain circumstances, cause seizures in people with conditions such as epilepsy.
- Studies have shown that certain people, even when they hear a fire alarm signal, do not respond to or comprehend the meaning of the signal. Audible devices, such as horns and bells, can have different tonal patterns and frequencies. It is the property owner's responsibility to conduct fire drills and other training exercises to make people aware of fire alarm signals and instruct them on the proper reaction to alarm signals.
- In rare instances, the sounding of a warning device can cause temporary or permanent hearing loss.

**A life safety system** will not operate without any electrical power. If AC power fails, the system will operate from standby batteries only for a specified time and only if the batteries have been properly maintained and replaced regularly.

**Equipment used in the system** may not be technically compatible with the control panel. It is essential to use only equipment listed for service with your control panel.

**Telephone lines** needed to transmit alarm signals from a premises to a central monitoring station may be out of service or temporarily disabled. For added protection against telephone line failure, backup radio transmission systems are recommended.

**The most common cause** of life safety system malfunction is inadequate maintenance. To keep the entire life safety system in excellent working order, ongoing maintenance is required per the manufacturer's recommendations, and UL and NFPA standards. At a minimum, the requirements of NFPA 72 shall be followed. Environments with large amounts of dust, dirt, or high air velocity require more frequent maintenance. A maintenance agreement should be arranged through the local manufacturer's representative. Maintenance should be scheduled monthly or as required by National and/or local fire codes and should be performed by authorized professional life safety system installers only. Adequate written records of all inspections should be kept.

Limit-D-1-2013

# Installation Precautions

*Adherence to the following will aid in problem-free installation with long-term reliability:*

**WARNING - Several different sources of power can be connected to the fire alarm control panel.** Disconnect all sources of power before servicing. Control unit and associated equipment may be damaged by removing and/or inserting cards, modules, or interconnecting cables while the unit is energized. Do not attempt to install, service, or operate this unit until manuals are read and understood.

**CAUTION - System Re-acceptance Test after Software Changes:** To ensure proper system operation, this product must be tested in accordance with NFPA 72 after any programming operation or change in site-specific software. Re-acceptance testing is required after any change, addition or deletion of system components, or after any modification, repair or adjustment to system hardware or wiring. All components, circuits, system operations, or software functions known to be affected by a change must be 100% tested. In addition, to ensure that other operations are not inadvertently affected, at least 10% of initiating devices that are not directly affected by the change, up to a maximum of 50 devices, must also be tested and proper system operation verified.

**This system** meets NFPA requirements for operation at 0-49° C/32-120° F and at a relative humidity 93% ± 2% RH (non-condensing) at 32°C ± 2°C (90°F ± 3°F). However, the useful life of the system's standby batteries and the electronic components may be adversely affected by extreme temperature ranges and humidity. Therefore, it is recommended that this system and its peripherals be installed in an environment with a normal room temperature of 15-27° C/60-80° F.

**Verify that wire sizes are adequate** for all initiating and indicating device loops. Most devices cannot tolerate more than a 10% I.R. drop from the specified device voltage.

**Like all solid state electronic devices,** this system may operate erratically or can be damaged when subjected to lightning induced transients. Although no system is completely immune from lightning transients and interference, proper grounding will reduce susceptibility. Overhead or outside aerial wiring is not recommended, due to an increased susceptibility to nearby lightning strikes. Consult with the Technical Services Department if any problems are anticipated or encountered.

**Disconnect AC power and batteries** prior to removing or inserting circuit boards. Failure to do so can damage circuits.

**Remove all electronic assemblies** prior to any drilling, filing, reaming, or punching of the enclosure. When possible, make all cable entries from the sides or rear. Before making modifications, verify that they will not interfere with battery, transformer, or printed circuit board location.

**Do not tighten screw terminals** more than 9 in-lbs. Overtightening may damage threads, resulting in reduced terminal contact pressure and difficulty with screw terminal removal.

**This system contains static-sensitive components.** Always ground yourself with a proper wrist strap before handling any circuits so that static charges are removed from the body. Use static suppressive packaging to protect electronic assemblies removed from the unit.

**Follow the instructions** in the installation, operating, and programming manuals. These instructions must be followed to avoid damage to the control panel and associated equipment. FACP operation and reliability depend upon proper installation.

Precau-D1-9-2005

## FCC Warning

**WARNING:** This equipment generates, uses, and can radiate radio frequency energy and if not installed and used in accordance with the instruction manual may cause interference to radio communications. It has been tested and found to comply with the limits for class A computing devices pursuant to Subpart B of Part 15 of FCC Rules, which is designed to provide reasonable protection against such interference when devices are operated in a commercial environment. Operation of this equipment in a residential area is likely to cause interference, in which case the user will be required to correct the interference at his or her own expense.

## Canadian Requirements

This digital apparatus does not exceed the Class A limits for radiation noise emissions from digital apparatus set out in the Radio Interference Regulations of the Canadian Department of Communications.

Le présent appareil numérique n'émet pas de bruits radioélectriques dépassant les limites applicables aux appareils numériques de la classe A prescrites dans le Règlement sur le brouillage radioélectrique édicté par le ministère des Communications du Canada.

HARSH™, NIS™, and NOTI•FIRE•NET™ are all trademarks; and Acclimate® Plus, FlashScan®, NION®, NOTIFIER®, ONYX®, ONYXWorks®, UniNet®, VeriFire®, and VIEW® are all registered trademarks of Honeywell International Inc. Echelon® is a registered trademark and LonWorks™ is a trademark of Echelon Corporation. ARCNET® is a registered trademark of Datapoint Corporation. Microsoft® and Windows® are registered trademarks of the Microsoft Corporation.

©2014 by Honeywell International Inc. All rights reserved. Unauthorized use of this document is strictly prohibited.

## Software Downloads

In order to supply the latest features and functionality in fire alarm and life safety technology to our customers, we make frequent upgrades to the embedded software in our products. To ensure that you are installing and programming the latest features, we strongly recommend that you download the most current version of software for each product prior to commissioning any system. Contact Technical Support with any questions about software and the appropriate version for a specific application.

## Documentation Feedback

Your feedback helps us keep our documentation up-to-date and accurate. If you have any comments or suggestions about our online Help or printed manuals, you can email us.

Please include the following information:

- Product name and version number (if applicable)
- Printed manual or online Help
- Topic Title (for online Help)
- Page number (for printed manual)
- Brief description of content you think should be improved or corrected
- Your suggestion for how to correct/improve documentation

Send email messages to:

**FireSystems.TechPubs@honeywell.com**

Please note this email address is for documentation feedback only. If you have any technical issues, please contact Technical Services.

# Table of Contents

<b>Section 1: General Information.....</b>	<b>8</b>
1.1: About This Manual .....	8
1.2: UL 864 Compliance.....	8
1.2.1: Products Subject to AHJ Approval.....	8
1.2.2: Programming Features Subject to AHJ Approval .....	8
1.3: Related Documents .....	9
1.4: Introduction to the Control Panel .....	11
1.4.1: Features.....	11
1.5: Navigating Menu and Programming Screens .....	11
1.6: Basic Procedure .....	12
1.7: Getting Started .....	12
1.7.1: Password Change.....	12
<b>Section 2: Main Menu .....</b>	<b>15</b>
2.1: Event Counts Display .....	15
2.2: Multiple Event List .....	15
2.3: History Display (History Select Screen).....	15
2.4: Read Status .....	16
2.5: Program/Alter Status.....	16
2.6: Printer Functions.....	16
<b>Section 3: Program .....</b>	<b>17</b>
3.1: General Information.....	17
3.2: Panel Program.....	18
3.2.1: Panel Program Menu (1).....	18
3.2.2: Network Parameters .....	18
3.2.3: Network Mapping.....	20
3.2.4: Panel Settings .....	21
3.2.5: Panel Timers (Menu 1).....	29
3.2.6: Panel Timers (Menu 2).....	30
3.2.7: LCD Programming .....	31
3.2.8: ACS Programming .....	32
3.2.9: Supervision .....	38
3.3: Panel Program Menu (2).....	40
3.3.1: Password Change.....	40
3.3.2: Weekly Occupancy Schedule.....	40
3.3.3: Remote Display Menu .....	41
3.3.4: Loop Configuration .....	42
3.3.5: Custom Action Message.....	44
3.3.6: Event Logging .....	45
3.3.7: Holiday Menu.....	45
3.4: Point Program .....	46
3.4.1: Detector Point.....	47
3.4.2: Module Point .....	55
3.4.3: General Zone .....	61
3.4.4: Releasing Zone .....	62
3.4.5: Logic Zone.....	62
3.4.6: Trouble Zone .....	66
3.4.7: Annunciator Board Label .....	67
3.4.8: Audio Point Programming.....	69
3.5: Delete Program .....	69
3.6: Autoprogram Menu .....	71
3.6.1: To Create a New Program .....	71
3.6.2: To Add/Delete Devices from the Program .....	71
3.6.3: Confirmation Screens .....	73

<b>Section 4: Alter Status .....</b>	<b>77</b>
4.1: Disable/Enable Point Selection.....	78
4.2: Disable/Enable .....	79
4.3: Detector Sensitivity.....	80
4.3.1: Sensitivity Select .....	80
4.4: Clear Verify Counters .....	82
4.5: Clear History.....	82
4.6: Walk Test.....	83
4.6.1: Walk Test Menu .....	85
4.6.2: Walk Test Loops Parameters .....	86
4.6.3: Point Walk Test Activation .....	87
4.6.4: Devices Test Selection.....	88
4.6.5: Zone Walk Test Activation.....	89
4.6.6: Aborting Walk Test .....	90
4.7: Program Time/Date.....	90
4.8: Control On/Off Point Select.....	91
4.8.1: Control Off.....	91
4.8.2: Control On .....	92
4.9: Wireless.....	93
4.10: Service Mode FFAST Detector .....	95
4.11: Reset Baseline FFAST Detector .....	96
<b>Section 5: Service Screens .....</b>	<b>98</b>
5.1: Version Information .....	98
5.2: Power-up Screen .....	99
5.3: Bootloader Screen.....	100
5.3.1: LCD-160 Download Menu .....	100
5.3.2: Loop Download Menu .....	101
5.4: Download Screen.....	102
5.5: Application Corrupt Screen .....	102
<b>Appendix A: Menu Hierarchy.....</b>	<b>103</b>
A.1: Screens Overview .....	103
<b>Appendix B: Releasing Applications .....</b>	<b>108</b>
B.1: Releasing Zones .....	108
B.2: NFPA Releasing Applications.....	109
B.3: Abort Switches .....	109
B.3.1: ULI Abort Switch.....	111
B.3.2: IRI Abort Switch .....	112
B.3.3: NYC Abort Switch.....	113
B.3.4: AHJ Abort Switch.....	115
B.3.5: Cross Zones.....	116
B.3.6: Using Type Codes for Releasing Zones.....	117
B.4: Miscellaneous.....	128
B.4.1: Initiating Devices .....	128
B.4.2: Warning Sounders.....	129
B.4.3: Auxiliary Control Functions .....	129
B.4.4: ACS Annunciation .....	129
<b>Appendix C: Special Zone Outputs.....</b>	<b>130</b>
C.1: Presignal and Positive Alarm Sequence (PAS).....	130
C.1.1: What is Presignal and PAS?.....	130
C.1.2: Selecting Presignal and PAS Outputs .....	130
C.2: Drill Mode .....	131
C.2.1: What is Drill Mode?.....	131
C.3: Mass Notification .....	132

<b>Appendix D: Intelligent Sensing Applications .....</b>	<b>134</b>
D.1: Intelligent Sensing Overview.....	134
D.2: Intelligent Sensing Features.....	134
D.2.1: Drift Compensation and Smoothing.....	134
D.2.2: Maintenance Warnings – Three Levels.....	135
D.2.3: Self-Optimizing Pre-Alarm .....	136
D.2.4: Detector Sensitivity .....	136
D.2.5: Cooperative Multi-Detector Sensing.....	137
D.3: Pre-Alarm.....	137
D.3.1: Definition.....	137
D.3.2: Alert Level.....	137
D.3.3: Action Level .....	138
D.4: Detector Sensitivity Settings.....	138
D.4.1: How to Select Pre-Alarm and Alarm Sensitivity.....	138
D.4.2: To Test Detectors Set Below 0.50% Obscuration per Foot.....	140
D.5: Detector Status Display.....	140
D.5.1: Detector Maintenance Display .....	140
D.5.2: Print a Detector Maintenance Report .....	141
D.5.3: To Interpret a Detector Status Display or Maintenance Report .....	142
<b>Appendix E: CBE: Zones and Equations.....</b>	<b>146</b>
E.1: Zones .....	146
E.2: Equations.....	147
E.2.1: Arguments .....	148
E.2.2: Logic Equations .....	148
E.2.3: Trouble Equations .....	152
<b>Appendix F: Detector Initialization.....</b>	<b>153</b>
F.1: Overview.....	153
F.2: To Replace a Detector with a Different Type of Detector .....	153
<b>Appendix G: Type Codes .....</b>	<b>154</b>
G.1: What Are Type Codes?.....	154
G.2: How to Select a Type Code .....	154
G.3: Type Codes for Input Devices .....	154
G.3.1: Overview.....	154
G.3.2: Type Codes for Intelligent Detectors.....	154
G.3.3: Type Codes for Monitor Modules .....	156
G.4: Type Codes for Output Devices .....	157
G.5: FlashScan Codes.....	159
<b>Appendix H: System Troubles.....</b>	<b>160</b>
<b>Appendix I: Regional Settings .....</b>	<b>165</b>
I.1: Singapore.....	165
I.2: Chicago.....	166
I.3: Australia .....	166
I.4: China .....	167
<b>Appendix J: Network Display Mode .....</b>	<b>168</b>
J.1: Limitations .....	168
J.2: Event, Mass Notification, and Drill Mapping.....	168
J.3: Panel Control Functions.....	168
J.3.1: Print Functions .....	168
<b>Glossary.....</b>	<b>170</b>
<b>Index.....</b>	<b>172</b>

# Section 1: General Information

## 1.1 About This Manual

The following graphics appear in the manual to indicate a caution, a warning, or a note.



**WARNING:**  
INFORMATION ABOUT PROCEDURES THAT COULD CAUSE IRREVERSIBLE DAMAGE TO THE CONTROL PANEL, IRREVERSIBLE LOSS OF PROGRAMMING DATA OR PERSONAL INJURY.



**CAUTION:**  
INFORMATION ABOUT PROCEDURES THAT COULD CAUSE PROGRAMMING ERRORS, RUNTIME ERRORS, OR EQUIPMENT DAMAGE.



**NOTE:** Information that highlights an important part of the preceding or subsequent text or illustration.

## 1.2 UL 864 Compliance

### 1.2.1 Products Subject to AHJ Approval

This product has been certified to comply with the requirements in the Standard for Control Units and Accessories for Fire Alarm Systems, UL 864 9th Edition.

A complete listing identifying which products have or have not received UL 864 9th Edition certification is located in the installation manual of this fire alarm system. These products may only be used in retrofit applications. Operation of the NFS2-3030 with products not tested for UL 864 9th Edition has not been evaluated and may not comply with NFPA 72 and/or UL 864. These applications will require the approval of the local Authority Having Jurisdiction (AHJ).

### 1.2.2 Programming Features Subject to AHJ Approval

This product incorporates field-programmable software. The features and/or options listed below must be approved by the local AHJ.

This product incorporates field-programmable software. In order for the product to comply with the requirements in the Standard for Control Units and Accessories for Fire Alarm Systems, UL 864, certain programming features or options must be limited to specific values or not used at all as indicated below.			
Program Feature or Option	Permitted in UL 864? (Y/N)	Possible Settings	Settings Permitted in UL 864
IP downloads over a local area network (LAN) or the internet (Wide Area Network - WAN)	No	Yes No Timed	No
Releasing: Abort Switch	Yes	NYC AHJ ULI IRI	ULI IRI
Detector Programming: Supervisory Type Codes	Yes	SUP L(DUCTI) SUP T(DUCTI) SUP T(DUCTP) SUP L(DUCTP) SUP L(ION) SUP T(ION) SUP L(PHOTO) SUP T(PHOTO) SUP L(LASER) SUP T(LASER) P/CO (P SUP)	SUP L(DUCTI) SUP T(DUCTI) SUP L(DUCTP) SUP T(DUCTP)



This product incorporates field-programmable software. In order for the product to comply with the requirements in the Standard for Control Units and Accessories for Fire Alarm Systems, UL 864, certain programming features or options must be limited to specific values or not used at all as indicated below.			
Program Feature or Option	Permitted in UL 864? (Y/N)	Possible Settings	Settings Permitted in UL 864
AC Fail Delay Timer	Yes	None, or 1-12 hours	1-3 hours
Regional Settings	Yes	Singapore Chicago Australia China	Chicago
FMM-4-20 Event Settings	Yes	No Event Trouble Fire Supervisory Security Nonfire Critical Process	No Event Trouble Supervisory Security Nonfire Critical Process

## 1.3 Related Documents

The table below provides a list of document sources (manuals) containing additional information regarding the NFS2-3030 and optional peripherals. The NOTIFIER document (DOC-NOT) chart provides the current document revision. A copy of this document is included in every NOTIFIER shipment.

Compatible Conventional Devices (Non-addressable)	Document Number
Device Compatibility Document	15378
Fire Alarm Control Panel (FACP) and Main Power Supply Installation	Document Number
NFS2-3030 Installation, Operations, and Programming Manuals	52544, 52545, 52546
AMPS-24/E Addressable Power Supply Manual	51907
SLC Wiring Manual	51253
Note: For individual SLC Devices, refer to the <i>SLC Wiring Manual</i> *Note: Also documents some retrofit equipment manufactured under UL 8th edition	
Audio System and Component Installation	Document Number
DVC Digital Voice Command Manual	52411
DAL Devices Reference Document	52410
DVC-RPU Manual	50107425-001
DVC-RPU UL Listing Document	50107424-001
DAA2 and DAX Series Digital Audio Amplifiers	53265
DS-DB Digital Series Distribution Board and Amplifier	53622
AA-Series Audio Amplifier Manual	52526
Heat Dissipation for Cabinets with Audio Products	53645
Off-line Programming Utility	Document Number
VeriFire™ Tools CD help file	Available for download
Cabinets & Chassis	Document Number
CAB-3/CAB-4 Series Cabinet Installation Document	15330
Battery/Peripherals Enclosure Installation Document	50295
Power Supplies, Auxiliary Power Supplies & Battery Chargers	Document Number
ACPS-610 Addressable Power Supply Manual	53018
ACPS-2406 Installation Manual	51304
APS2-6R Auxiliary Power Supply	53232
CHG-120 Battery Charger Manual	50641
FCPS-24 Field Charger/Power Supply Manual	50059
FCPS-24S6/S8 Field Charger/Power Supply Manual	51977

Table 1.1 Related Documents (1 of 2)

<b>Networking</b>	<b>Document Number</b>
Noti•Fire•Net Manual, Network Version 4.0 & Higher	51584
*Note: Also documents some retrofit equipment manufactured under UL 8th edition	
High Speed Noti•Fire•Net Manual	54013
NCM-W/F Installation Document	51533
HS-NCM High Speed Network Communications Module Installation Document	54014
NCS ONYX™ Network Control Station, Network Version 4.0 & Higher Manual	51658
NCA-2 Network Control Annunciator Manual	52482
NCA Network Control Annunciator Manual	51482
<b>System Components</b>	<b>Document Number</b>
Annunciator Control System Manual	15842
Annunciator Fixed Module Manual	15048
ACM-8R Annunciator Control Module Manual	15342
LCD-80 Manual	15037
LCD2-80 Liquid Crystal Display	53242
LCD-160 Manual	51850
LDM Series Lamp Driver Annunciator Manual	15885
SCS Smoke Control Manual (Smoke and HVAC Control Station) Manual	15712
RPT-485W/RPT-485WF EIA-485 Annunciator Loop Repeater	15640
DPI-232 Manual	51499
TM-4 Installation Document (Reverse Polarity Transmitter)	51490
UDACT Manual (Universal Digital Alarm Communicator/Transmitter)	50050
UDACT-2 Listing Document	54089LD
UDACT-2 (Universal Digital Alarm Communicator/Transmitter) Listing Document	54089LD
ACT-1 Installation Document	52527
ACT-2 Installation Document	51118
ACT-4 Installation Document	53431
ACT-25 Installation Document	53432
ACT-70 Installation Document	53240
FireVoice 25/50 Series	52290
RM-1 Series Remote Microphone Installation Document	51138
RA100Z Remote LED Annunciator Document	156-0508
RFX Wireless Interface Manual	51012
UZY-256 Universal Zone Coder Manual	15216
UZY-256 Programming Manual	15976
XP Transponder Manual	15888
XP10-M Ten Input Monitor Module Installation Document	156-1803
XP5 Series Manual	50786
XP6-C Supervised Control Module Installation Document	156-1805
XP6-MA Six Zone Interface Module Installation Document	156-1806
XP6-R Six Relay Control Module Installation Document	156-1804
FSA-8000 FFAST Intelligent Aspiration Sensing Technology Document	156-3903
XPIQ Audio Transponder Manual	51013
SWIFT™ Network Manual	LS10036-000NF-E

Table 1.1 Related Documents (2 of 2)

## 1.4 Introduction to the Control Panel

The NFS2-3030 is an intelligent Fire Alarm Control Panel (FACP) with features suitable for most applications.

There are two basic configuration options for the NFS2-3030. It can be ordered with:

- a front display/keypad, which allows programming and viewing options at the panel, or
- no display/keypad.

This manual gives programming instructions using the front display/keypad.

### Displayless Mode

When there is no keypad/display at the panel, it is controlled by remote annunciators. VeriFire™ Tools programming is required. The displayless panel has four buttons on its circuit board that are service-level switches for local operation should it become necessary. They are the only buttons, and are clearly marked with ACK for Acknowledge, SIGSIL for Signal Silence, SYSRST for System Reset, and LAMP TEST. These buttons are mainly for installer use: the operator should utilize a remote annunciator for these functions, if possible. The status indicator LEDs on the circuit board are the same as on the display/keypad; refer to the *NFS2-3030 Operating Manual* for LED descriptions.

Refer to VeriFire™ Tools for information on programming without an NFS2-3030 display/keypad. A PC is required when using VeriFire™ Tools.

Canadian applications must conform to ULC requirements for displays and network control. Refer to the Canadian Applications appendix in this panel's installation manual.

### 1.4.1 Features

Programming features include the following:

- Ease of use - Field program the control panel without special software skills.
- Local programming - program directly from the control panel keypad to reduce installation time.
- PC programming - input long data entry programming information on a PC; transfer programming data between a PC and the control panel.
- Autoprogram option - automatically detect newly installed, addressable devices, allowing quicker installation.
- Security - use passwords to control access to the control panel and protect programming.
- Large display option - 640 character screen, 16 lines x 40 characters

## 1.5 Navigating Menu and Programming Screens

The Main Menu (refer to Figure 2.1) leads to screens with various menu and programming options. Choices may be made from the menu screens by pressing the soft key closest to the menu option. Appendix A, "Menu Hierarchy" gives the programming menu hierarchy; refer to this appendix for an overall view of the layout of the screens.

Field information may be added/modified using the keyboard and special function keys.

Arrow keys on the keyboard can be used to navigate between fields on a screen if there are no soft keys to select the fields.

Scrolling through a list of selections in a screen field can be performed either by repeatedly pressing the associated soft key, or by pressing the Next Selection/Previous Selection special function keys on the Display/Keypad.

Pressing a BACK soft key on a screen returns the programmer to the previous screen without saving the information entered.

Pressing an **ACCEPT** soft key will save the information entered on the screen. It may also return to the previous screen and/or perform other functions as described in the soft key section for each screen.

When the FACP can not read an address (that is, if the point entered on the screen for processing does not exist) it will display an error screen for several seconds, then return to the screen where the address was entered. The user must check his input and investigate the state of the point.

## 1.6 Basic Procedure

For initial programming of the panel, or for major changes and additions, the following basic procedure is recommended to prevent errors resulting in reprogramming and wasted time.

- Use work sheets to record the exact information for every detector, module, annunciator point and software zone in the system. Pay close attention to the Software Type IDs. For voice systems, pay close attention to AMG annunciator point commands. The panel program may also be created using VeriFire™ Tools and downloaded to the panel after assembly and power-up.
- Assemble and apply power to the control panel as described in this panel's installation manual. All system boards must be physically installed.
- Read this manual before programming.
- Enter/change master and user passwords.
- Enter panel and network parameters.
- Program all devices and thoroughly test the entire system. The Walk Test feature can be used to test devices and their programming.
- Make a hard-copy record of the program on the printer.
- Save the program by uploading it using VeriFire™ Tools.

## 1.7 Getting Started

Once the system has been physically installed, programming may begin. The user may program at any time except while there is an unacknowledged alarm present.

To ensure security, passwords should be entered at this time to replace the factory default settings.

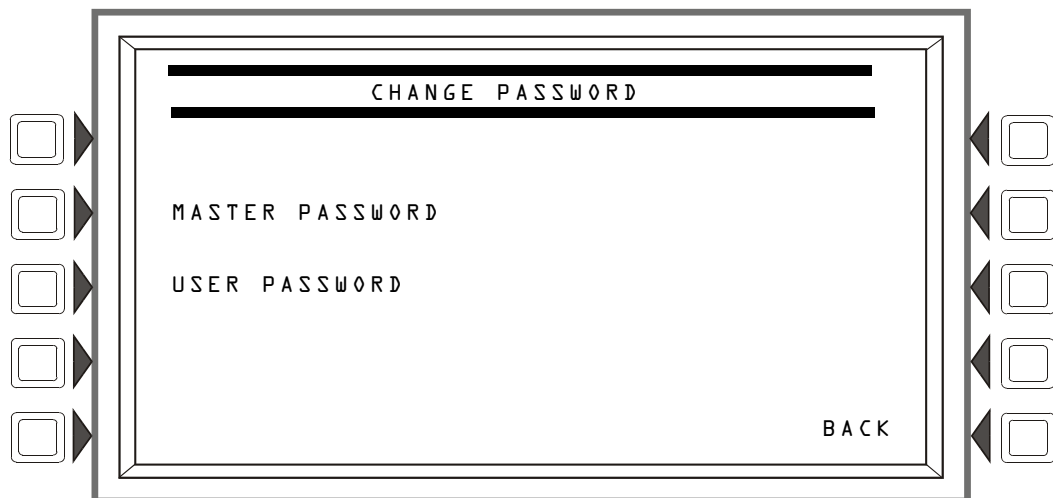
### 1.7.1 Password Change

The NFS2-3030 has two password levels; master and user. There is one master password, which grants access to all system programming. There are nine user passwords, each of which may be assigned access to the programming change menus, the alter status menus, or both. A user password does not give access to or allow change to any password parameters, not even its own. Only the master password will allow access to password change screens.

The panel arrives with factory default settings of 00000000 for the master password, and 11111111 for one user password.

Follow the steps below to change the factory settings:

1. Press **PROGRAM/ALTER STATUS** at the Main Menu screen.
2. Using the keyboard, enter eight zeros (00000000) after **ENTER PASSWORD**.
3. Press the **ACCEPT** soft key.
4. Press the **PANEL PROGRAM MENU** soft key.
5. Press the **MORE** soft key.
6. Press the **PASSWORD CHANGE** soft key.



**Figure 1.1 Change Password Screen**

### Soft Keys

MASTER PASSWORD - Press to change the master password

USER PASSWORD - Press to change the user password.




---

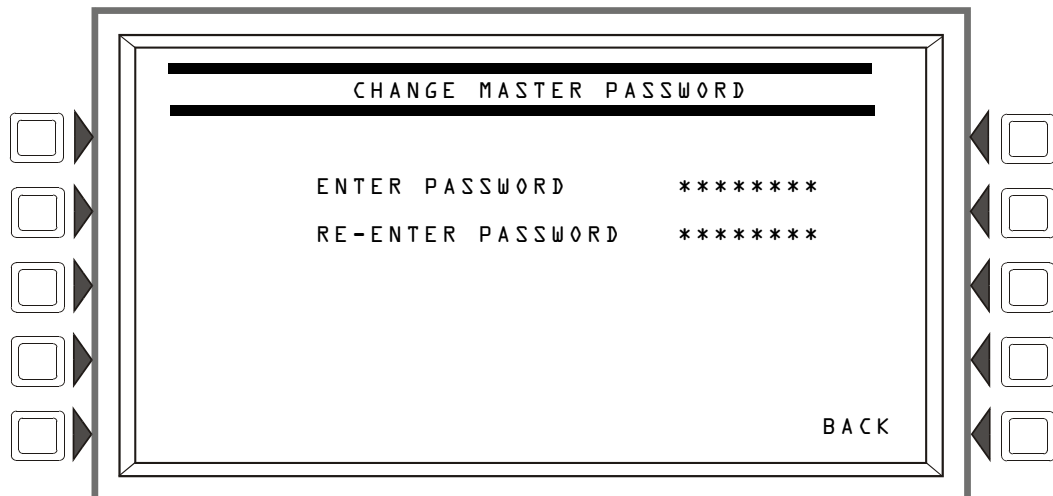
**NOTE:** Only a master can change another password.

---

### Master Password

Press the MASTER PASSWORD Soft Key to display the following screen. Enter a new password that will replace the factory default password: there can be up to eight alphanumeric characters.

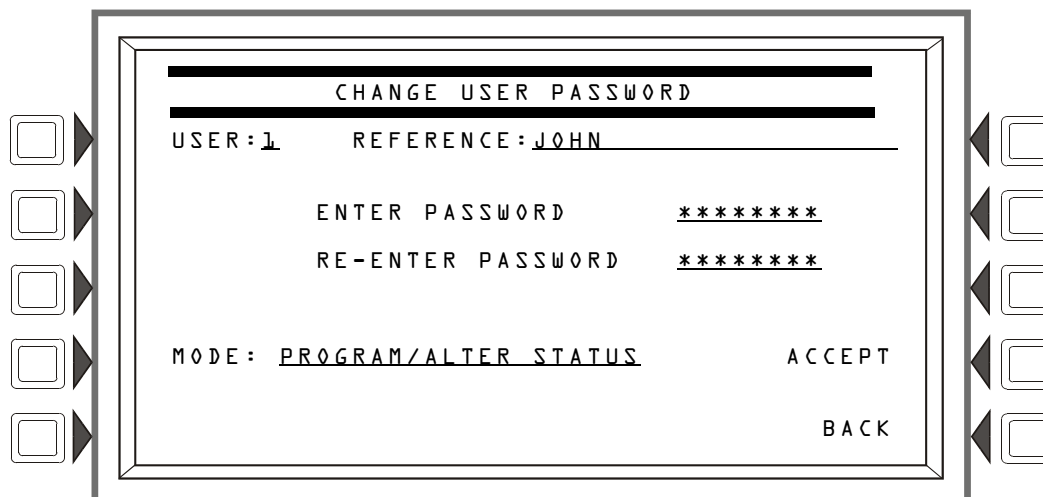
Press the enter key on the keyboard. RE-ENTER PASSWORD will appear. Reenter the password for verification. Press enter to save the new password.



**Figure 1.2 Change Master Password Screen**

## User Password

Press the **USER PASSWORD** soft key to display the following screen.



**Figure 1.3 Change User Password Screen**

### Soft Keys

**USER:** Press this soft key to scroll through the nine user password numbers. When this key is pressed, the rest of the display will update to reflect information for each new record. Stop at the password number that requires entering.

**MODE:** Press this soft key to select the user's level of access. Levels are as follows:

- **PROGRAM/ALTER STATUS** Gives access to the Program Change Menu and Alter Status Menu.
- **ALTER STATUS** Gives access to the Alter Status Menu
- **NONE** Gives no access.

**REFERENCE:** Press this key to enter a maximum 20-character alphanumeric label that identifies the user. Press the enter key on the display/keyboard to enter the information.

**ENTER PASSWORD** - Press to enter a new password. Enter up to eight alphanumeric characters, then press enter. **RE-ENTER PASSWORD** will appear. Retype the password for verification.

**ACCEPT:** After entering all password information and retyping the password at the prompt, press this soft key to save all the password information.

### Incorrect or Forgotten Password

If a password is entered incorrectly, the panel will respond by displaying an **INVALID PASSWORD** message and a code. The programmer may hit the escape key and re-enter the password correctly. However, if the password has been forgotten, record the code and contact **NOTIFIER**. After proper authentication, the master password can be determined by deciphering the code. An example of the message that would appear on the display follows:

```
INVALID PASSWORD:
  9066-21FS-7D78-5FA4-6163
  Code _____
```

## Section 2: Main Menu

The Main Menu screen is the means by which the programmer can access displays, history information, printing and programming menus. This screen is accessible from the System Normal Screen, and from most other screens by pressing the BACK soft key until it displays.

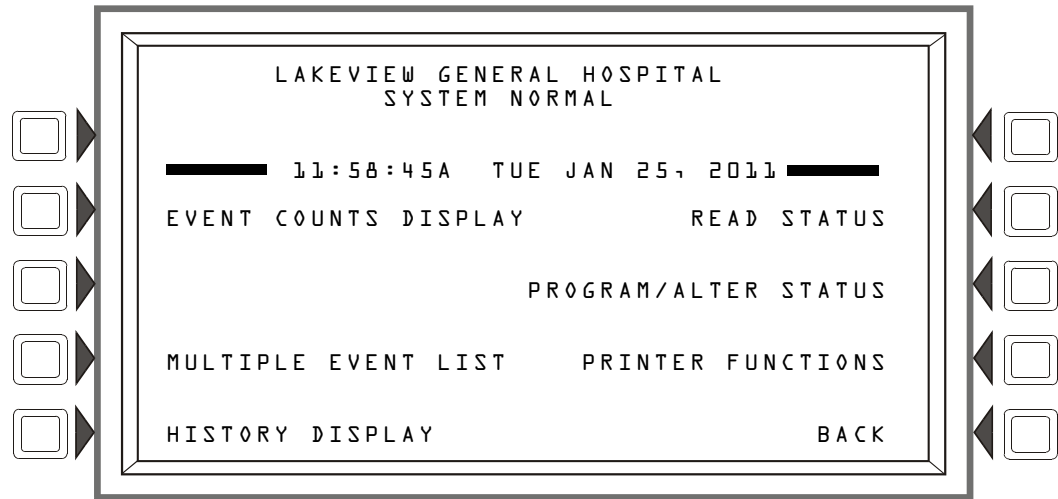


Figure 2.1 Main Menu Screen

### Soft Keys

Pressing the soft keys brings the user to the screens described below.

## 2.1 Event Counts Display

Pressing the EVENT COUNTS DISPLAY soft key on the Main Menu brings up the EVENT COUNTS screen. This screen will automatically display if an off-normal event requiring acknowledgement occurs. The display consists of current counts of off-normal events in six categories: the counts include both acknowledged and unacknowledged events.

Refer to this panel's operations manual for an illustration and description of the Event Counts Display.

## 2.2 Multiple Event List

Pressing the Multiple Event List soft key shows off-normal events simultaneously in groups of eight. It displays automatically for off-normal events when the Canada event order has been selected. Refer to Event Ordering in "Panel Settings" on page 21 for information on display order.

Refer to this panel's operations manual for an illustration and description of the Multiple Event List.

## 2.3 History Display (History Select Screen)

The History Select screen allows the user to select a type of history file to view, and to set time/date or point range viewing parameters.

Refer to this panel's operations manual for an illustration and description of History Display.

## 2.4 Read Status

Pressing the Read Status soft key brings up screens to view the present status of points, zones, and other system information. Refer to this panel's operations manual for a full description of Read Status.

## 2.5 Program/Alter Status

Pressing the Program/Alter Status soft key brings up screens for panel programming, point programming, autoprogramming, clear programming, altering the status of points, walk test, and other information. Refer to Sections 3, and 4 for a full description of Program/Alter Status.

## 2.6 Printer Functions

Pressing the Printer Functions soft key brings up screens to print reports. Refer to this panel's operations manual for a description of Printer Functions. This key will appear only if a printer operation has been selected. Refer to "Supervision" on page 38 for selection information.



# Section 3: Program

## 3.1 General Information

The NFS2-3030 operates with two levels of programming: Program, and Alter Status.

Program level allows change to the essential control panel functions such as point functions, system functions, and passwords. Program level change requires the master password, or a user password that allows access to the Program level. All password information can be changed with a master password only.

Alter Status level allows change to operating parameters, such as detector sensitivity, or time/date, or Walk Test. The master password, or a user password that allows access to the Alter Status level, is required.

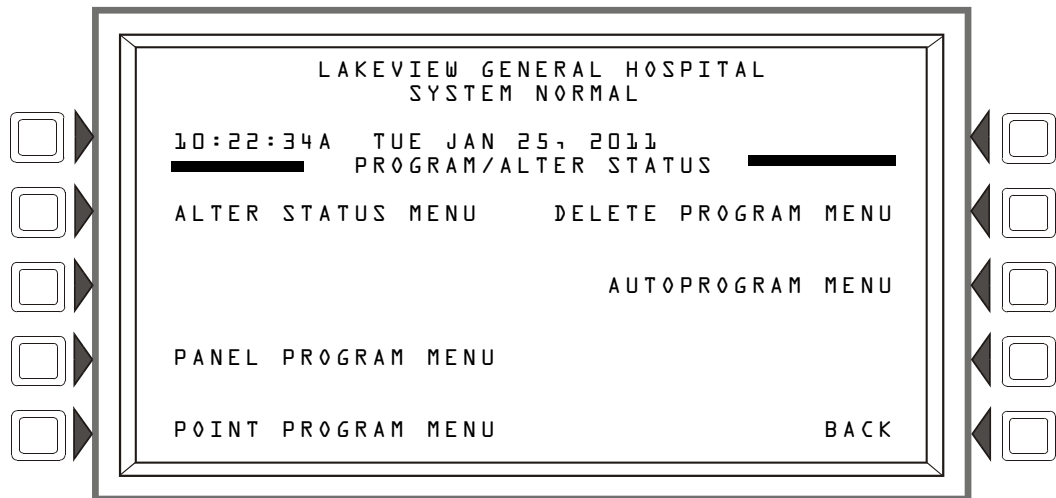


**NOTE:** All events except troubles are annunciated during programming. When an annunciated event occurs, the panel will automatically exit the programming screen and the Event Counts menu screen will appear.

To access the Program level, press the Program/Alter Status soft key on the Main Menu and at the prompt enter a master password, or a user password that allows access to the Program level. The following screen will display.



**NOTE:** No program menus will display if a user password is entered that has access to Alter Status level only: the Alter Status menu will be the sole menu choice.



**Figure 3.1 Program/Alter Status Screen**

Press a soft key with the word “program” in its menu to bring up the associated program menu.

When programming the panel for the first time, press the **DELETE PROGRAM MENU** soft key, which brings up the Delete Program Menu screen (Refer to Figure 3.60). Press the **CLEAR ALL PROGRAMMING** button, then **ACCEPT**, to ensure that the panel is set to defaults and clear of programs.



**NOTE:** Clearing all programs is not necessary when initial programming with a database downloaded from VeriFire™ Tools.

The logical sequence for initial programming is to program the panel parameters first, then to program the individual points through autoprogramming and/or point programming.

## 3.2 Panel Program

Panel programming provides the means to change settings for the panel system as a whole, as well to address and program annunciator points.

### 3.2.1 Panel Program Menu (1)

Press the Panel Program Menu for the following choices.

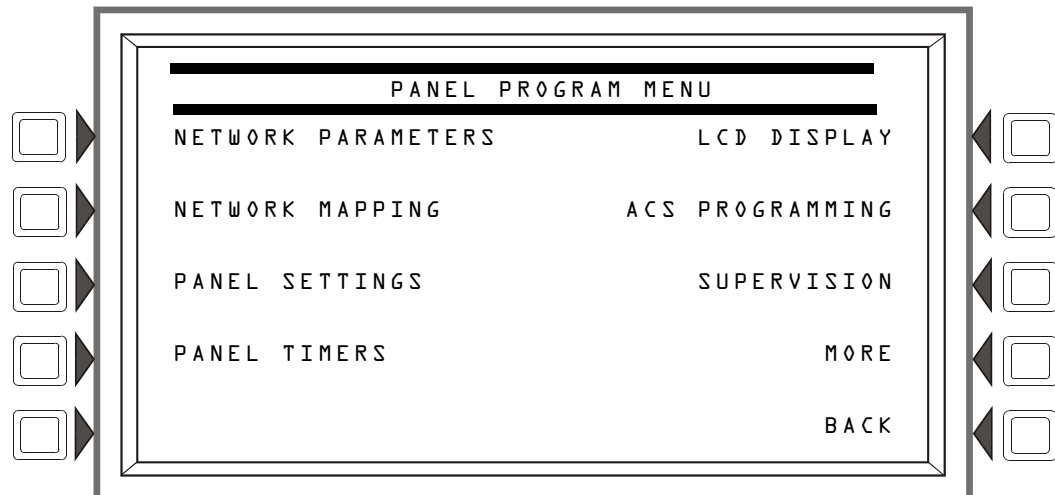


Figure 3.2 Panel Program Menu 1 Screen

### 3.2.2 Network Parameters

Press the Network Parameters soft key on Panel Program Menu 1 to bring up the following screen. If the panel will operate as a standalone unit and not part of a network, the node label is the only field that needs to be entered: it is the label that appears as part of the System Normal message.

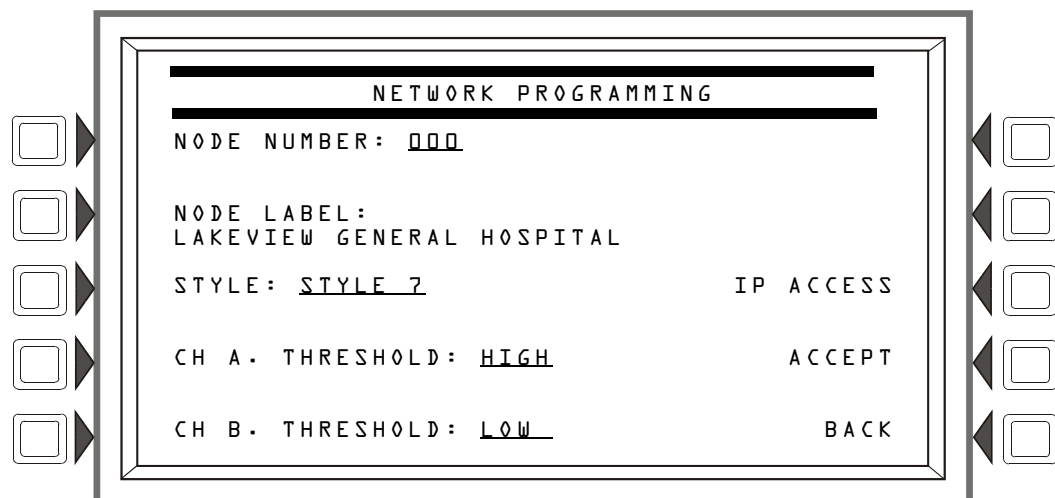


Figure 3.3 Network Programming Screen

### Soft Keys

**NODE NUMBER**: Enter the network node number of this panel. For standalone NFS2-3030, the network node number will be 000. A valid network node number range is 1-240. Once the soft key has been pressed, the number may be typed in from the keypad, or the Next/Previous Selection special function key on the keypad may be used to toggle through online node numbers. The network node number may be viewed by pressing the Lamp Test special function key longer than five seconds. (Refer to Section 5.1, “Version Information”, on page 98.) Default: 000

**NODE LABEL**: Enter the network node label for this panel. This is the label that appears in the System Normal message. Default: <blank>

**STYLE**: Select the wiring style as 4 or 7. Default: style 4

**CHANNEL A THRESHOLD**, **CHANNEL B THRESHOLD**: Enter HIGH or LOW, for high or low threshold setting for channel A or B on the network communications module. Default: HIGH

**IP ACCESS**: Press this soft key to bring up the IP ACCESS screen.

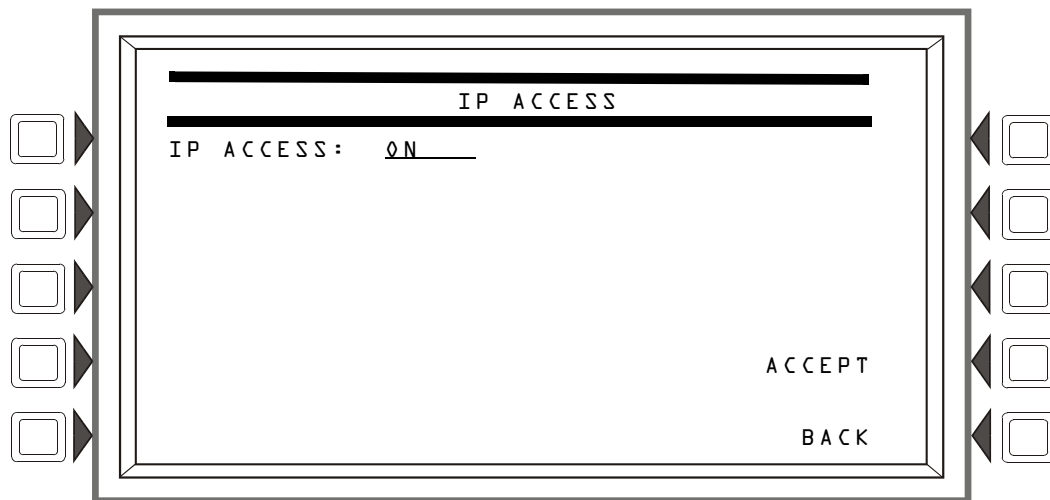
**ACCEPT**: Press this soft key to save the information entered on this screen.

### IP ACCESS Screen



**NOTE:** Use of the IP ACCESS feature is subject to the approval of the local AHJ.

This screen allows the programmer to set the IP Access. This setting allows the disabling/enabling of commands, downloads and programming from the Wide Area Network (WAN).



**Figure 3.4 IP Access Screen**

### Soft Keys

**IP ACCESS**: Press the soft key to scroll through the choices. Press **ACCEPT** at the desired setting.

Settings are:

ON - IP commands, downloads and programming are allowed.

OFF - IP commands, downloads and programming are *NOT* allowed. (default)

TIMED - IP commands, downloads and programming are allowed for a two-hour period, after which the setting will revert to OFF.



**NOTE:** Enabling IP ACCESS allows downloads over a local area network (LAN) or the internet (Wide Area Network - WAN) using VeriFire™ Tools through the Noti•Fire•Net™ Web Server (NWS), or a wide-area enabled NCS through a PC version of Noti•Fire•Net™ Gateway.

Always verify system operation after programming changes are made in this manner.

### 3.2.3 Network Mapping

The Network Mapping softkey is only available if the Network Display Mode option is enabled. Pressing the softkey will display the following screen. Refer to Appendix J, “Network Display Mode”, on page 168.

There are 15 of these screens covering nodes 1 through 240. Each screen will have 16 nodes on it. The up and down arrow keys are used to select which node to edit. When a field is selected, the NEXT SELECTION/PREVIOUS SELECTION keys will toggle between OFFLINE/ONLINE, MAPPED/UNMAPPED.

- **OFFLINE** - The node is not communicating on the network.
- **ONLINE** - The node is communicating on the network.
- **MAPPED** - Events are annunciated by the NFS2-3030. When a node is mapped to the NFS2-3030, it is automatically mapped for mass notification events as well. Mass Notification mapping can be disabled separately from event mapping via VeriFire Tools.
- **UNMAPPED (blank)** - Events are ignored by the NFS2-3030.



**NOTE:** The NFS2-3030 can be programmed to monitor events and initiate drill on one (1) additional fire panel or gateway and up to four (4) DVCs.

NEXT navigates to the next screen in the sequence. The last screen will not have a NEXT key. BACK will go to the preceding screen in the sequence or to the Node Programming menu if the current screen is the first one in the 15-screen sequence. ACCEPT implements any changes that have been made up to this point and returns the user to the Node Programming menu. AUTO PROGRAM will consult the internal map of which nodes are on the network and automatically set all 240 Nodes according to the map, regardless of which screen is being shown. The results will not be saved to flash until the ACCEPT key is pressed.

- Main menu
  - ↳ Program/alter status menu
    - ↳ Panel program menu
      - ↳ Network mapping

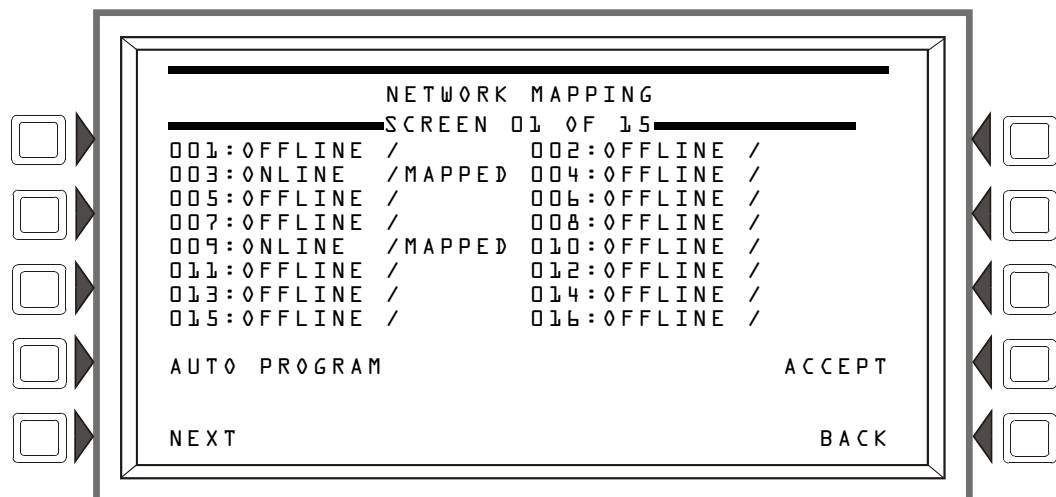
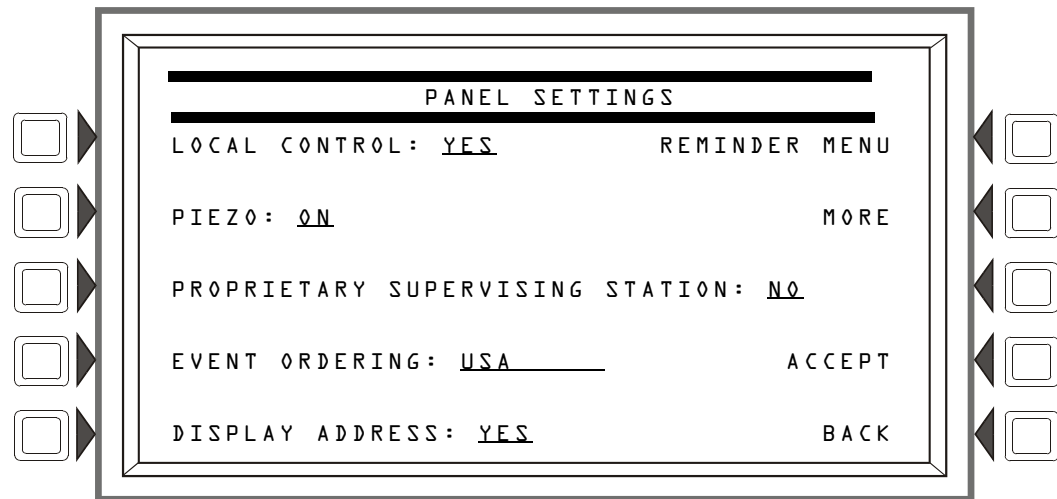


Figure 3.5 Program Menu: Network Mapping

## 3.2.4 Panel Settings

Press the Panel Settings soft key on the Panel Program Menu 1 screen to choose panel settings.



**Figure 3.6 Panel Settings (1) Screen**

### Soft Keys

**LOCAL CONTROL:** Press this soft key to toggle between YES and NO. This option disables (NO) or enables (YES) local panel control of the Signal Silence, System Reset, and Drill Fixed Function keys, as well as SIGNAL SILENCE, SYSTEM RESET, and ACKNOWLEDGE soft keys. A setting of NO (disable) turns the panel piezo sounder off, overriding the next field if PIEZO is set to ON. Default: YES



**NOTE:** A setting of NO (disable) will disable key switch operation.



**NOTE:** ACS devices programmed for acknowledge, signal silence, system reset and drill are not affected by this setting: these commands will still function at the devices if LOCAL CONTROL is set to NO.

**PIEZO:** Press this soft key to toggle between OFF and ON. This option enables (ON) or disables (OFF) the panel piezo from sounding when alarms or troubles occur. A setting of ON is overridden if LOCAL CONTROL is set to NO. Default: ON

**PROPRIETARY SUPERVISING STATION:** Press this soft key to enable (YES) or disable (NO) Local Receive mode. When enabled, events and the clearing of events must be handled one at a time: each must be acknowledged. Latching events require a system reset. The panel will override a setting of YES if the Node Number is greater than zero. Default: NO



**NOTE:** Proprietary Supervising Station does not support standalone mode (direct connect) with a Digital Voice Command.

**EVENT ORDERING:** Press this soft key to toggle between USA and CANADA ordering priorities. This order is applied to events shown in the Multiple Events List screen. Default: USA

With Fire as the highest priority:		With MNS as the highest priority:	
USA Event Order	Canada Event Order	USA Event Order	Canada Event Order
Fire	Fire	MN Alarm	MN Alarm
MN Alarm	MN Alarm	Fire	Fire
CO Alarm	CO Alarm	CO Alarm	CO Alarm
CO Pre-alarm	CO Pre-alarm	CO Pre-alarm	CO Pre-alarm
Security	—	Security	—
Supervisory	Supervisory	MN Supervisory	MN Supervisory
MN Supervisory	MN Supervisory	Supervisory	Supervisory
Trouble	Trouble	MN Trouble	MN Trouble
MN Trouble	MN Trouble	Trouble	Trouble
Pre-alarm	Pre-alarm	Pre-alarm	Pre-alarm
Disabled	Disabled	Disabled	Disabled

Note: Fire/MNS priority dependent on fire panel programming. Refer to page 27 for priority programming.

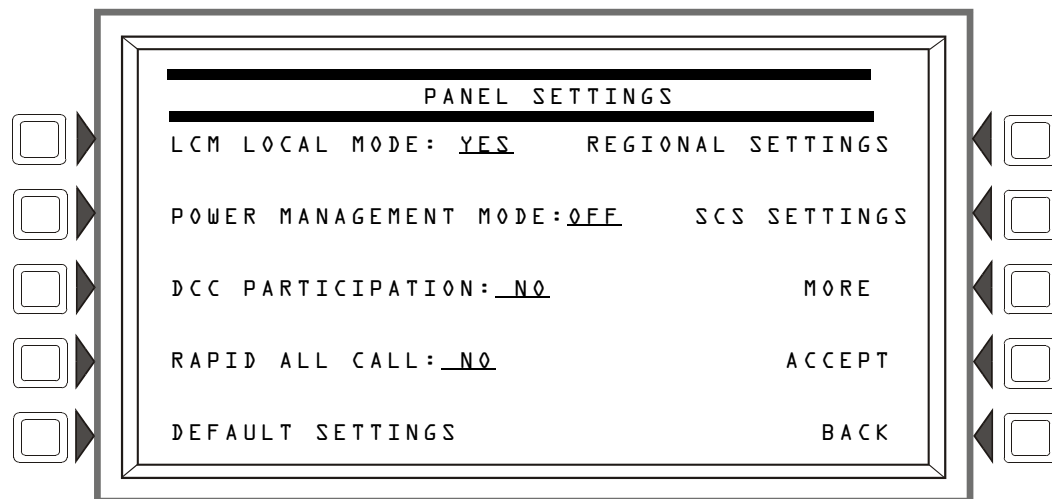
**Table 3.1 Event Ordering**

**DISPLAY ADDRESS:** Press this soft key to toggle between YES and NO. Choose YES to display all point address information at the top of event screens and in printouts. Choose NO to suppress address information display and printing. Default: YES

**REMINDER MENU:** Press this soft key to bring up the Reminder Menu screen.

**ACCEPT:** Press this soft key to save the information entered on this screen.

**MORE:** Press this key to progress to the second Panel Settings screen.



**Figure 3.7 Panel Settings (2) Screen**

**Soft Keys**

**LCM LOCAL MODE:** Press this soft key to toggle between YES and NO. Enter YES to enable all SLCs to participate in local mode. When enabled, all LCMs will operate together in a limited fashion when communication is lost with the NFS2-3030 CPU. Inputs on LCM loops (and associated LEM loops, if installed) will activate outputs on all loops

- for those inputs and outputs that have been set with point programming to participate in local mode, and

- when type codes are the same point type: that is, an input with a fire type code will activate an output with a fire type code. (Refer to Appendix G, “Type Codes”, on page 154 for point types).

Default: N0

**POWER MANAGEMENT MODE:** Select ON to invoke the power management mode to conserve power consumption. In this mode, the number of LEDs that can be turned ON on a particular loop will be limited. A maximum of 30 input device (monitor modules and detectors) LEDs will be allowed ON at a time. No output module LEDs will turn ON. When the limit of 30 LEDs is reached, every time a new LED is turned ON, the oldest LED activation will turn OFF and will poll in red rather than the usual green. Default: OFF

**DCC PARTICIPATION:** Press this key to program the panel for DCC (Display and Control Center) participation. This network function ensures that one location at a time is in command of the Acknowledge, System Reset, Signal Silence and Drill functions. Default: N0



**CAUTION:**

ON FIRE SYSTEMS UTILIZING THE DCC FUNCTION, ALL LOCATIONS THAT CAN PARTICIPATE IN DCC SHOULD BE SET TO YES. FOR MASS NOTIFICATION APPLICATIONS, THE DCC FUNCTION SHOULD SET TO N0 FOR ALL LOCATIONS.

**RAPID ALL CALL:** Set YES to invoke Rapid All Call for XP Series transponder modules. For use when retrofitting an AM-2020/AFP-1010 system that has XPP modules used for audio operation. This setting causes these modules to activate more quickly. Rapid All Call is used with the “Speaker” type code. Default: N0

**DEFAULT SETTINGS:** Press this soft key to activate default settings for the following:

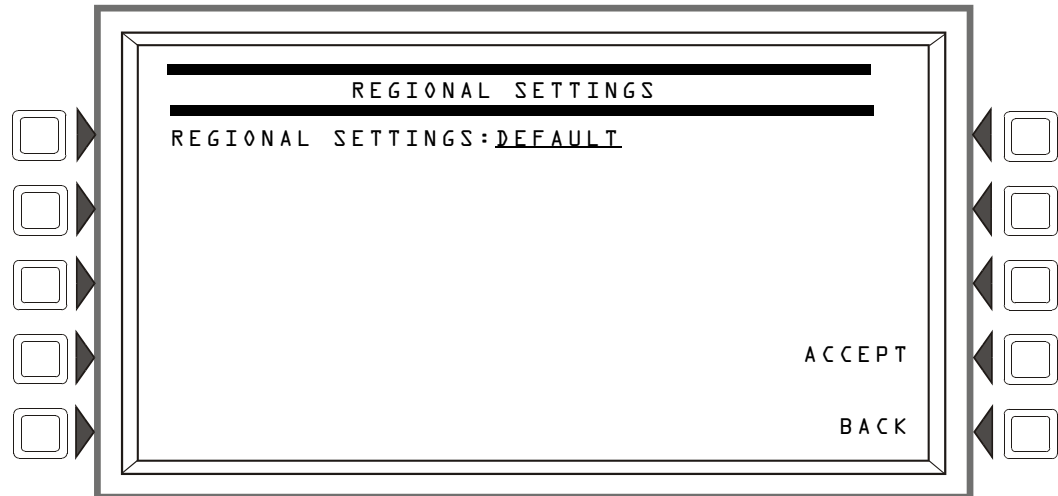
Program Setting for:	Default:
Local Control	YES
Piezo	ON
Proprietary Supervising Station	N0
Event Ordering	USA
Display Address	YES
LCM Local Mode	N0
DCC Participation	N0
Power Management	OFF
Rapid All Call	N0

**Table 3.2 Default Settings**

**REGIONAL SETTINGS:** Press this soft key to proceed to the Regional Settings screen.

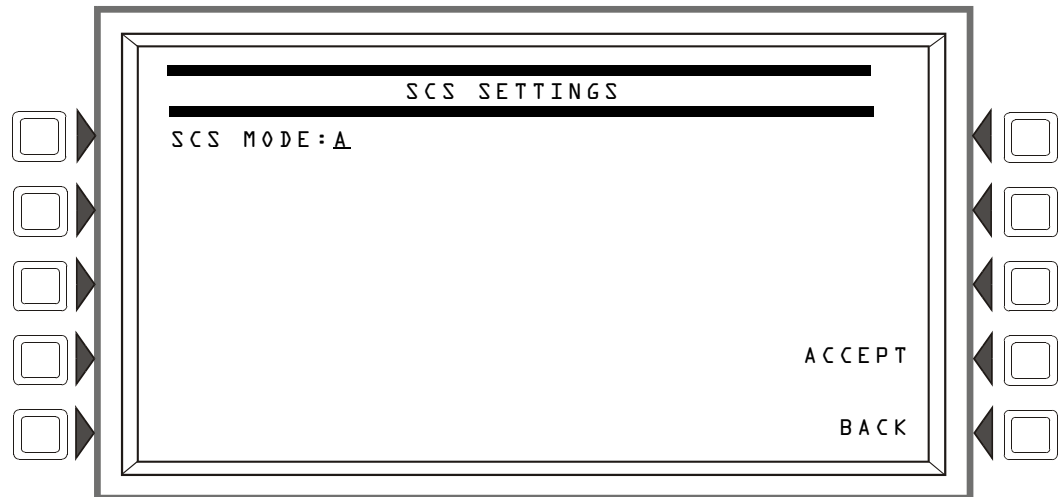
**SCS SETTINGS:** Press this soft key to proceed to the SCS Settings screen.

**MORE:** Press this key to progress to the third Panel Settings screen.



**Figure 3.8 Regional Settings Screen**

**REGIONAL SETTINGS:** Press the soft key to scroll through the selections. Choices are CHICAGO, SINGAPORE, AUSTRALIA, CHINA or DEFAULT. The default is that there are no special regional settings.

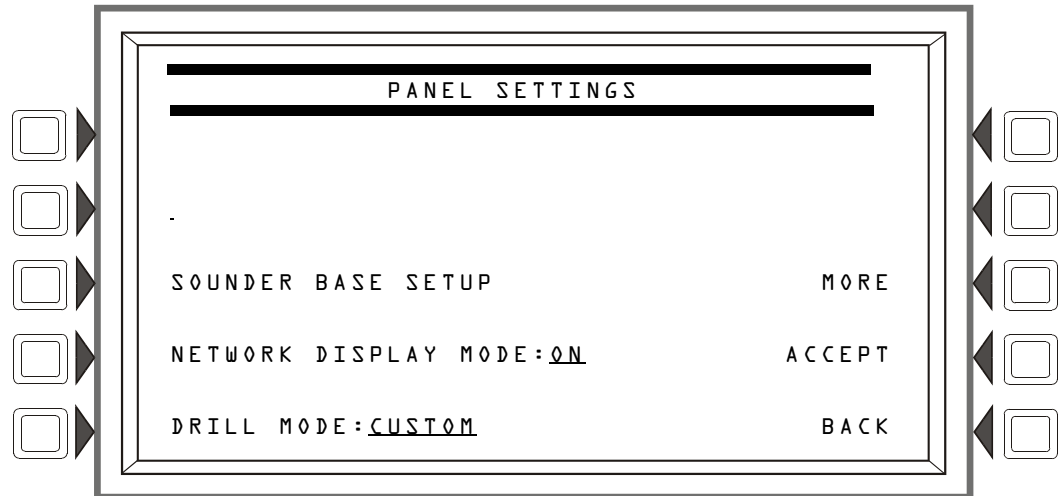


**Figure 3.9 SCS Settings Screen**

**SCS MODE:** Press to select mode A or mode B for SCS applications. Default: A

**Note:** For use with local SCS installations. Refer to the *Smoke and HVAC Control Station SCS Series Manual* for additional information.





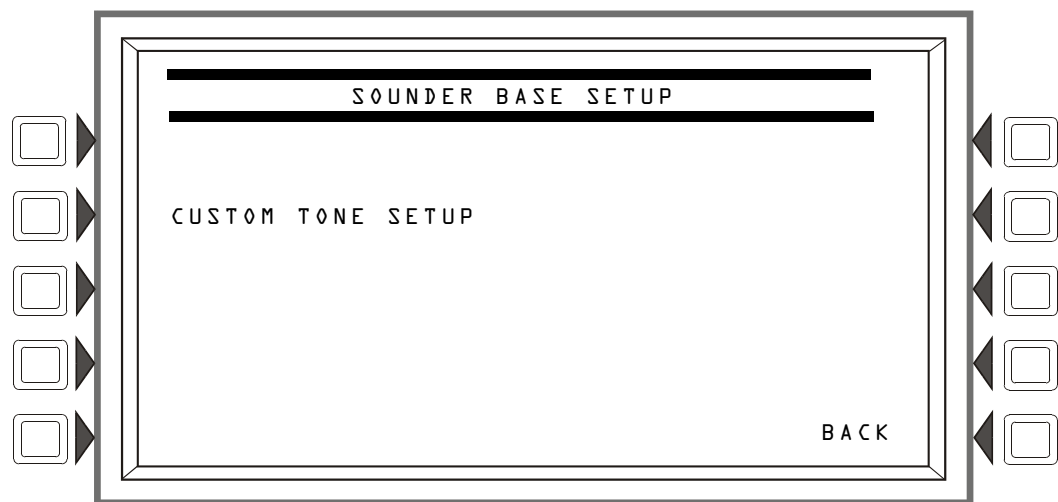
**Figure 3.10 Panel Settings (3) Screen**

**SOUNDER BASE SETUP:** Press this soft key to proceed to the SOUNDER BASE SETUP screen.

**NETWORK DISPLAY MODE:** Press this softkey to enable Network Display Mode for the fire panel. Network Display Mode allows the NFS2-3030 to display network events for up to five mapped network nodes. Refer to “Network Display Mode” on page 168.

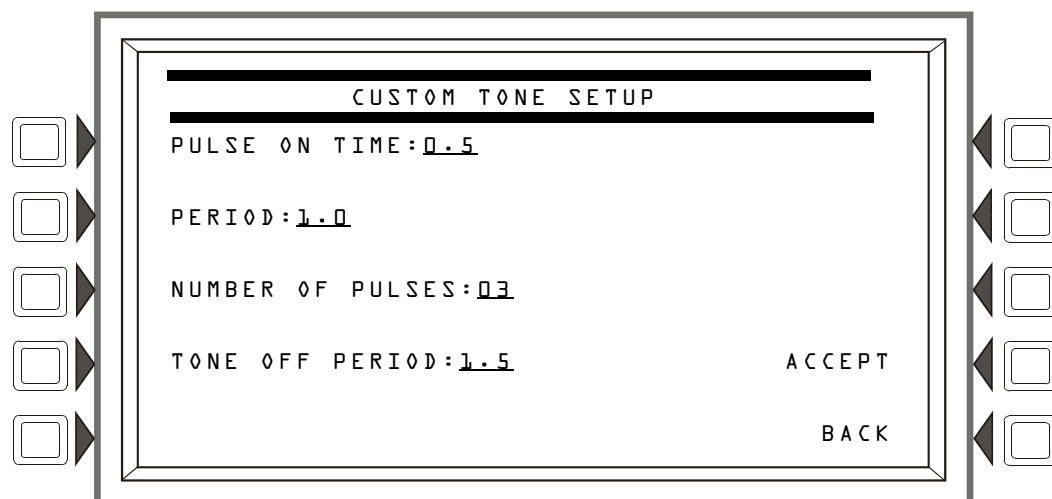
**DRILL MODE:** Press this soft key to select between the STANDARD and CUSTOM drill mode options. CUSTOM drill mode can be used to activate specific output devices when a drill occurs. When using CUSTOM drill mode, Special Function Zone 16 must be programmed into the zone mapping of the devices to be activated during a drill. For more information on Special Zones, refer to “Zones” on page 146. For more information about DRILL MODE, refer to Appendix C.2, “Drill Mode”, on page 131.

**MORE:** Press this key to progress to the fourth Panel Settings screen.

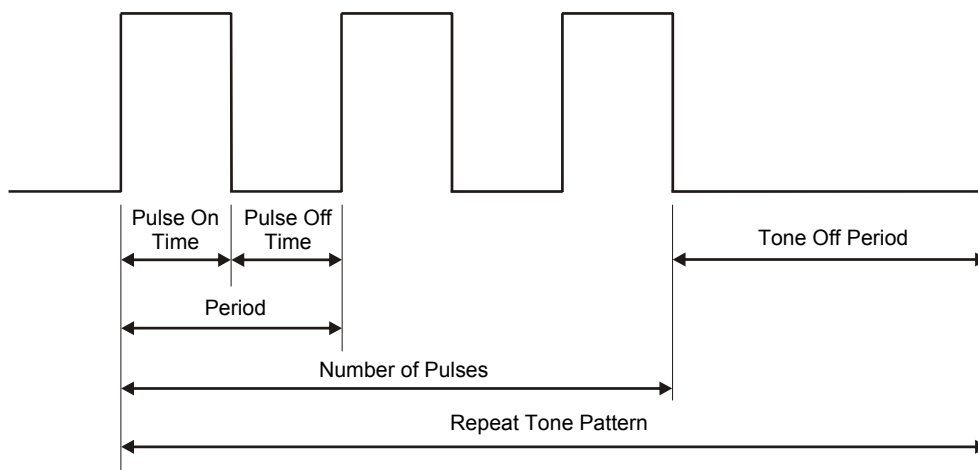


**Figure 3.11 Sounder Base Setup Screen**

**CUSTOM TONE SETUP:** Press this softkey to proceed to the Custom Tone Setup screen.



**Figure 3.12 Custom Tone Setup Screen**



**Figure 3.13 Custom Tone Example**

**PULSE ON TIME:** The Pulse On time is the amount of time that the tone will be ON within a Period. Press this softkey to enter the amount of time in second and fraction of a second increments.

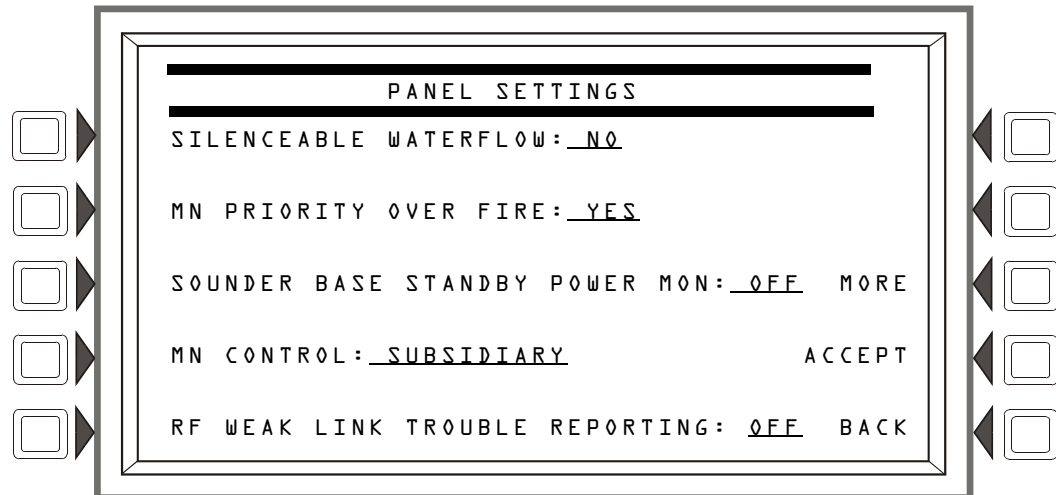
**PERIOD:** A Period is the length of time designated for a pulse, including Pulse On time and Pulse Off time. The pulse off time is designated by the amount of time left in a Period after the Pulse On time has expired. Press this softkey to enter the amount of time in second and fraction of a second increments.

**NUMBER OF PULSES:** Press this softkey to enter the number of pulses that will occur before the Tone Off Period.

**TONE OFF PERIOD:** The Tone Off Period is the amount of time that the tone will be silent before running the pulse pattern again. Press this softkey to enter the amount of time in seconds and fraction of a second increments.

For more information on programming the Intelligent Sounder Base, refer to “Detector Point” on page 47.

Pressing the MORE soft key on this Panel Settings screen will display this screen:



**Figure 3.14 Panel Settings (4) Screen**

**SILENCEABLE WATERFLOW:** If the SILENCEABLE WATERFLOW option is set to NO, incoming Waterflow events will not be allowed to be silenced. If set to YES, incoming Waterflow events can be silenced. Default: NO

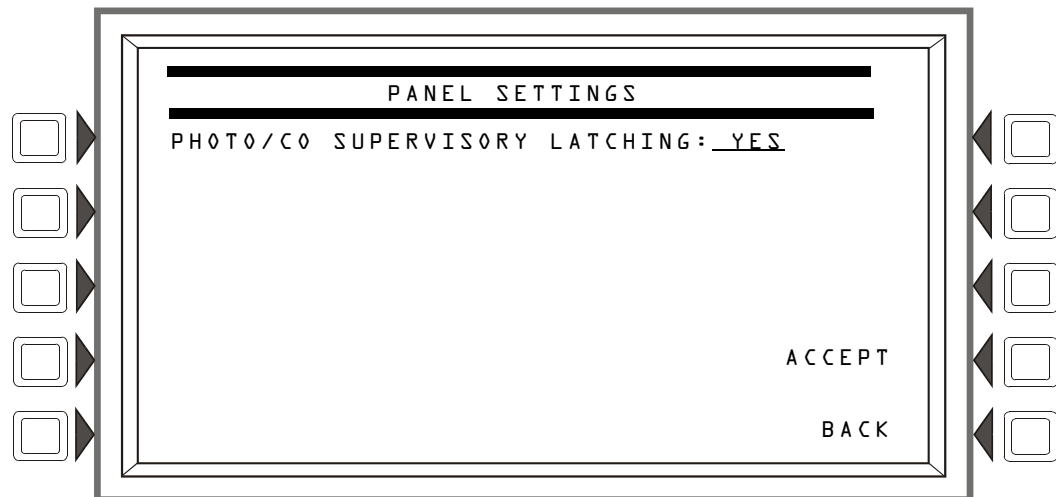
**MN PRIORITY OVER FIRE:** If the MN PRIORITY OVER FIRE option is set to NO, Fire events will have a higher priority than Mass Notification (MN) events. If set to YES, MN events will have a higher priority than Fire events. If set to MN NOT USED, this system is being used for fire protection only. Refer to Table 3.1 on page 22 for event order information.

**SOUNDER BASE STANDBY POWER MON:** If the SOUNDER BASE STANDBY POWER MON option is set to ON, external power on the sounder base will be monitored when in standby. If set to OFF, external power on the sounder base will not be monitored when in standby. Set to ON when the sounder base is powered by a constant 24 VDC. Default: OFF

**MN CONTROL:** Toggle between SUBSIDIARY, ACU, LOC, and CSS. This option should remain subsidiary if the NFS2-3030 is not in Network Control Mode. If SUBSIDIARY: Select subsidiary if the NFS2-3030 does not have an associated DVC set as an ACU, LOC, or CSS. If ACU, LOC, or CSS: Select ACU, LOC, or CSS to match the configuration programming of an associated DVC used for Mass Notification. Default: SUBSIDIARY

**RF WEAK LINK TROUBLE REPORTING:** Toggle between ON and OFF. If ON: The NFS2-3030 will report a trouble when a wireless device loses communication with the wireless gateway. If OFF: The NFS2-3030 does not report communication loss of the wireless devices to the wireless gateway. Default: ON

Pressing the MORE soft key on this Panel Settings screen will display this screen:

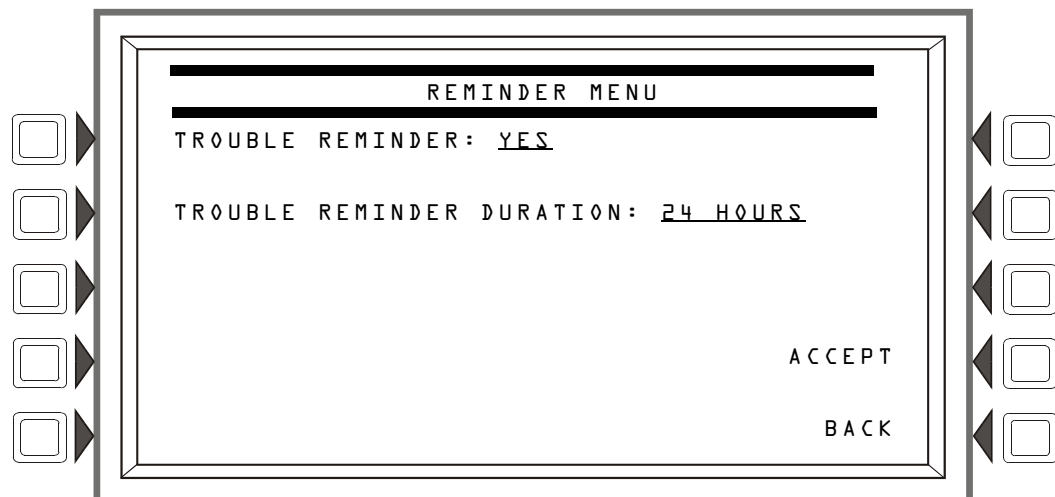


**Figure 3.15 Panel Settings (5) Screen**

**PHOTO/CO SUPERVISORY LATCHING:** Only applies to Photo/CO detectors programmed as PSUP: Toggle between YES and NO. This option will allow the photo element of any PSUP detectors on the fire panel to be latching or tracking. If NO: The photo element of all PSUP detectors will be tracking. If YES: The photo element of all PSUP detectors will be latching. Default: NO

### Reminder Menu

Press the Reminder Menu soft key on the Panel Program Menu 1 screen to set the trouble reminder.



**Figure 3.16 Reminder Menu Screen**

### Soft Keys

**TROUBLE REMINDER:** Press this soft key to toggle between the two possibilities:

**YES:** Choose this to initiate a daily 11:00AM reminder that there are uncleared troubles in the system. The reminder will appear on the screen and will sound a piezo (if the piezo is enabled).

**NO:** Choose this if no reminder is desired. Default: YES

**TROUBLE REMINDER DURATION:** Press this soft key to toggle between 4 Hours and 24 Hours to select the duration of time between trouble reminders.

4 HOURS: Choose to initiate a reminder every four hours until all troubles are clear. This option should be selected if the fire panel is connected to a wireless network via the FWSG.

24 HOURS: Choose to initiate a trouble reminder every 24 hours until all troubles are clear.  
Default: 24 HOURS

ACCEPT: Press this soft key to save the information entered on this screen.

### 3.2.5 Panel Timers (Menu 1)

Press the Panel Timers soft key on the Panel Program Menu 1 screen to display the following screen.

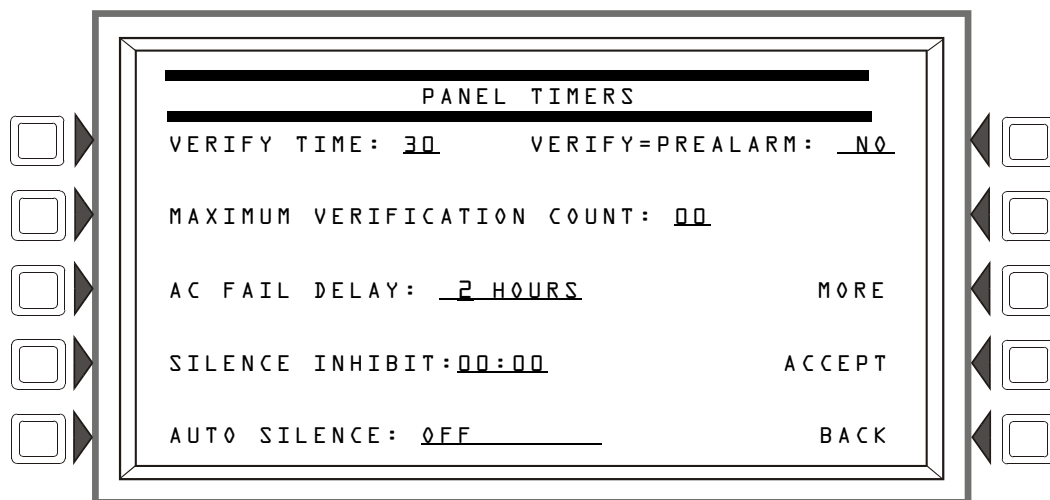


Figure 3.17 Panel Timers (Menu 1) Screen

#### Soft Keys

**VERIFY TIME:** Press this soft key to set the Alarm Verification timer. Type in a value of 0-60 (seconds), which will delay initiating devices set for Alarm Verification from signaling for the amount of time entered. If a second alarm occurs while the alarm verification timer is counting, the timer will stop and the alarm will signal immediately. Default: 30



**NOTE:** This value may not exceed 30 seconds for ULC installations.

**MAXIMUM VERIFICATION COUNT:** Press and enter a value from 0-20 for a maximum verification count threshold value that applies to detectors set to participate in Alarm Verification. A value of zero produces no verification trouble. When the counter exceeds the threshold value entered, a trouble is generated to the panel. Default: 20

**AC FAIL DELAY:** Press this soft key to set the timing for the time delay from AC failure to when the trouble is reported. Type in a value of 1-12 (hours), or select NONE. A value of NONE will cause immediate notification. Default: 8



**NOTE:** AC FAIL DELAY settings other than 1-3 hours for off-premises notification require the approval of the local Authority Having Jurisdiction.

The onboard trouble relay (TB3 on the CPU2-3030) will activate and TM-4s will report according to this setting.

UDACTs and UDACT-2s are notified immediately of AC failure by the panel, regardless of the panel's delay setting. Once the UDACT or UDACT-2 receives notification, it operates according to its own programmed AC Fail Delay reporting schedule.

Example: AC Failure occurs at 1:00 p.m. on a panel with an AC FAIL DELAY setting of 8 hours. The UDACT/UDACT-2 is set for notification after 6 hours

Time	Event
1:00 p.m.	AC Failure. Panel notifies UDACT/UDACT-2. Panel and UDACT/UDACT-2 timers begin countdown to report time.
7:00 p.m.	UDACT/UDACT-2 reports.
9:00 p.m.	TM-4 reports, TB3 trouble relay activates.

**Table 3.3 AC Fail Delay Example**

The AMPS-24, ACPS-610, and ACPS-2406 power supplies must be set to an AC FAIL DELAY value of 0 (zero) when used with this panel.

**SILENCE INHIBIT** : Press to enter a value from 0 (disabled) to 5 minutes. This software timer disables the SIGNAL SILENCE key function for the time entered when a fire alarm occurs. The timer starts at the first alarm only; it does not restart with each new alarm. Default: 0

**AUTO SILENCE** : Press to enter a value of OFF (no Auto Silence Timer), or a value of 10, 15 or 20 minutes. This global software timer functions like pressing the SIGNAL SILENCE key. For example, if a value of 10 is entered, the control panel will silence all active outputs programmed as silenceable after ten minutes. Default: OFF

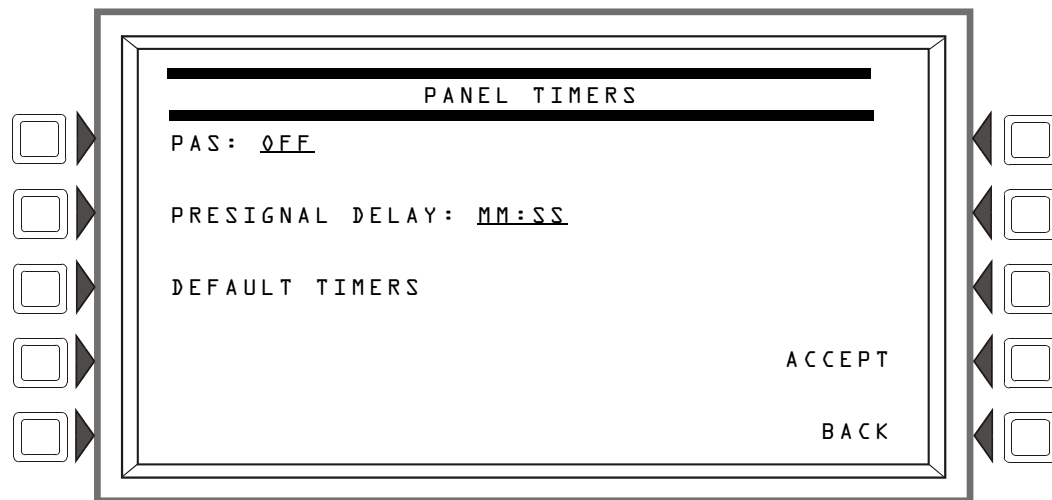


**NOTE:** This value must be 20 minutes for ULC installations.

**VERIFY=PREALARM** : Press this soft key to enter Yes or No for displaying Prealarm during alarm verification. Default: NO

### 3.2.6 Panel Timers (Menu 2)

Press the MORE soft key on the Panel Timers Menu 1 screen to display the following screen.



**Figure 3.18 Panel Timers (Menu 2) Screen**

#### Soft Keys

**PAS**: Press to toggle between the choices of OFF or ON for PAS (Positive Alarm Sequence). Refer to Appendix C, “Special Zone Outputs” for an explanation of this option. Default: OFF

**PRESIGNAL DELAY:** Press to enter a value of 00:00 (OFF) or a value of 1:00 to 3:00 minutes (in the format MM:SS, where MM= minutes, SS=seconds). This feature initially causes alarm signals to sound only in specific areas, monitored by qualified personnel. This allows delay of the alarm for up to 3 minutes after the start of alarm processing. Refer to Appendix C, “Special Zone Outputs” for further explanation of this option. Default: 3:00

**DEFAULT TIMERS:** Press this soft key to activate default settings for the following:

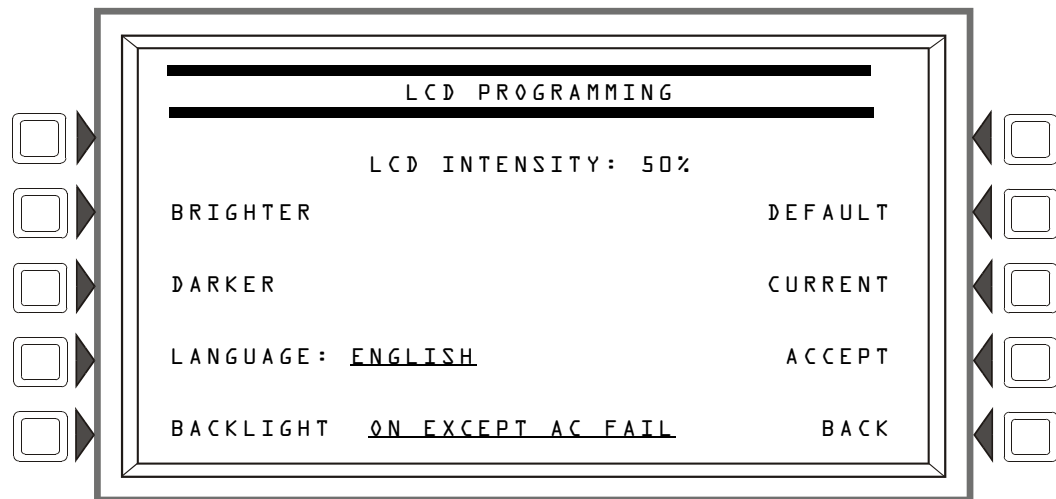
Program setting for:	Default:
Verify Time	30 seconds
Max. Verify	20
AC Fail Delay	8 hours
Silence Inhibit	0 (disabled)
Auto Silence	Off
Verify=Prealarm	No
PAS	OFF
Presignal Delay	3 minutes

**Table 3.4 Default Timers**

**ACCEPT:** Press this soft key to save the information entered on this screen and return to the previous screen.

### 3.2.7 LCD Programming

The LCD Programming screen allows the user to vary the contrast of the display and turn the backlight on or off.



**Figure 3.19 LCD Display Screen**

#### Soft Keys

**BRIGHTER:** Press this soft key to increase contrast. The intensity will increase by approximately 5% with each press of the key.

**DARKER:** Press this soft key to decrease contrast. The intensity will decrease by approximately 5% with each press of the key.

**LANGUAGE:** Press this soft to choose the language that will display on the LCD. Menu choices are ENGLISH, HEBREW, PORTUGUESE and SPANISH.

To change the language display on an LCD-160, refer to Section 5.3.1, “LCD-160 Download Menu”, on page 100.

**BACKLIGHT** : Press this soft key to select one of the following backlighting options: **ON EXCEPT AC FAIL**, **OFF**, or **ON**. When **ON EXCEPT AC FAIL** is selected, the backlight will turn off when the power supply experiences AC failure.

Default: **ON**

**DEFAULT** : Press to select the factory default setting (40%).

**CURRENT** : Press to select the intensity that was in effect when the screen was accessed.

**ACCEPT** : Line 5 (which displays **LCD INTENSITY : 50%** in the figure above) will change value when the **INTENSITY** soft keys are pressed. Press **ACCEPT** to save the desired setting.

### 3.2.8 ACS Programming

An ACS device is a remote device used by the panel to annunciate certain system messages, and/or to act with limited commands. A total of 32 annunciator devices may be present on the EIA-485 ACS circuit; however, some devices have associated expander devices, and an NFS2-3030 ACS circuit can accommodate up to 3,072 annunciator points. The ACS Programming and ACS Point Programming screens in this section allow the user to define the mapping and functional mode of these devices and points. Each annunciator board may be labeled using the ACS Label Menu. (Refer to Section 3.4.7, “Annunciator Board Label”, on page 67).



---

**NOTE:** Smoke Control devices must be set as FSCS or HVAC annunciator types. In addition to its 64 smoke control points, when an SCS device is operating in FSCS (Firefighters Smoke Control Station) mode, there are 32 additional points which function as alarm points. They can be mapped to a zone or point to send the SCS device into a fire alarm state when any of the additional 32 points is activated. Any of the 32 alarm points that are used must be set to **MONITOR** mode from the panel. Any of these points that are not used can be set to **NONE**. Refer to the SCS manual for further information on Smoke Control devices.

---

UDACT/UDACT-2 and TM-4 communicators, as well as the UZC Zone Coder, are installed on the same EIA-485 ACS circuit as annunciators, and so are included with annunciator programming. The TM-4 occupies one of the 32 annunciator addresses, and the UDACT or UDACT-2 can occupy one or more of these addresses. The UZC can occupy up to four annunciator addresses, each with 64 points. When the UDACT/UDACT-2 or UZC expand beyond one annunciator address, 64PT should be used for the subsequent address types, and the annunciator addresses should be sequential. Other than address assignment, there is no ACS point programming for these devices. Refer to the specific device manual for more information.



Press the ACS Programming soft key at the Panel Program screen to invoke the following screen. Press the up and down arrow keys on the keypad to navigate through the annunciator addresses. There will be a cursor highlighted at the current annunciator address position.

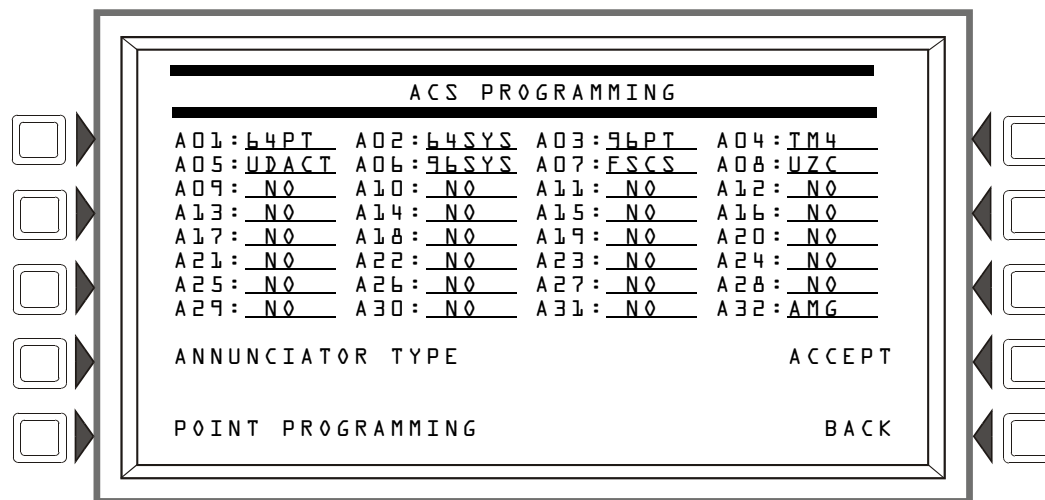


Figure 3.20 ACS Programming Screen

**Soft Keys**

**ANNUNCIATOR TYPE** : When the cursor is placed at the desired address, press this soft key to scroll through the following list of types. Stop at the appropriate type.

Type	Used for
64PT	64 point annunciation
64SYS	64 point annunciation, with first 8 points reserved
64SVC	64-point service mode for Two Level Bypass
96PT	96 point annunciation
96SYS	96 point annunciation, with first 8 points reserved
96SVC	96-point service mode for Two Level Bypass
96DCC	96 point annunciation to be used with multiple Command Centers
UDACT	UDACT or UDACT-2, first address. Any additional UDACT or UDACT-2 annunciator addresses should be programmed as 64PT and be sequential.
TM4	TM-4
AMG†	AMG
FSCS	Smoke control modules set for FSCS mode
HVAC	Smoke control modules set for HVAC mode
UZC	Universal Zone Coder, first address. Any additional UZC annunciator addresses should be programmed as 64PT and be sequential.

\* **Two Level Bypass**: When an ACS board is programmed as a 64SVC or 96SVC type, the operator must enter the Program/Alter Status mode of operation before pressing any push buttons to control points on these boards. If a push button is pressed while not in the Program/Alter Status screen, and no unacknowledged events exist, the password screen will automatically be displayed so the operator can enter the Program/Alter Status mode.

† **AMG Addressing**: When using an AMG, the address it occupies (an address of 25 through 32, typically address 32) must be set to annunciator type AMG, and address one must be set to annunciator type 64PT.

**POINT PROGRAMMING** : Press this soft key to proceed to the ACS Point Programming screen.

**ACCEPT** : Press this soft key to save all the changes made and return to the previous screen (Panel Program).

### ACS Point Programming

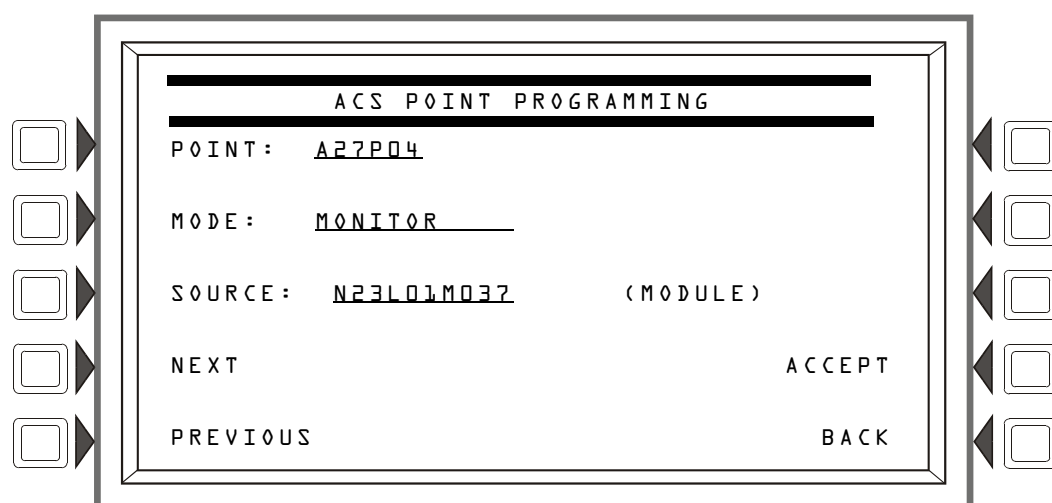
ACS Point Programming can be reached by pressing **P0INT PROGRAMMING** at the ACS Programming screen. This screen allows the programmer to assign a mode and sources to each annunciator point at the annunciator address. One ACS input may be used to control multiple SLC output modules by listing the output points in the **SOURCE** fields. This feature applies to the following Types: **64PT**, **64SYS**, **64SVC**, **96PT**, **96SYS**, **96SVC**, and **96DCC**.



**NOTE:** SLC output modules with releasing Type IDs may not be listed in the annunciator source fields.



**NOTE:** The NFS2-3030 supports ACM-24AT/ACM-48A annunciators and their expanders with either 64 or 96 points at an address, as well as ACM-16AT/ACM-32A/LDM-32 annunciators with 64 points at an address.



**Figure 3.21 Sample ACS Point Programming Screen**

#### Soft Keys

**P0INT :** Press this soft key to enter the ACS point number. The format is AxxPyy, where A is the two-digit device address, P is the two-digit point number. Enter a leading zero for one-digit numbers.

**MODE :** Press this soft key to enter the ACS mapping mode. Table 3.5 shows the possible mode choices and descriptions of their functions.

ACS Point Mode	Function: The point...	Explanation
NONE	... is not programmed.	No messages are sent from or received at this point. LEDs at this point do not light.
CONTROL	... will change the state of up to eight control modules OR (for NFS2-3030 only) up to eight general zones to off or on when its button is pushed. Selecting this point mode will bring up the Control Point Select screen (refer to Figure 3.22).	The Point Active LED is lit if a corresponding mapped point is active. The Status (trouble) LED is on when a point or zone is in trouble.
MONITOR	... will show the current status of a specified point or zone.	The Point Active LED is lit if the corresponding mapped point or zone is active. The Status (trouble) LED is on if that point or zone is in trouble. If the point has a button, it has no effect when pushed.

**Table 3.5 ACS Point Mapping: Explanation of Point Modes (1 of 3)**

ACS Point Mode	Function: The point...	Explanation
TELEPHONE	... supports telephone functionality when mapped to a telephone point. Press the button to connect the mapped point with the telephone station.	Both the Point Active LED and the Status (trouble) LED will flash if a telephone has been placed in the jack at the mapped telephone point. Otherwise, the Point Active LED is lit if the corresponding point or zone is active. The Status (trouble) LED is lit if that point or zone is in trouble.
DISABLE	... will change the state of a point, zone, or DAA speaker circuit(s) specified through mapping from enabled to disabled, or from disabled to enabled, when its button is pushed. See Caution below this table.	The Point Active LED is lit if the corresponding mapped point or zone is active. The Status (trouble) LED is lit only if that point or zone is disabled.
ACKNOWLEDGE	... will act like an Acknowledge soft key or button on the panel, acknowledging an event when its button is pushed.	The Point Active LED is lit when there are any fire alarms in the system. The Status (trouble) LED is lit when there are troubles in the system.
SILENCE	... will act like the Signal Silence button on the panel, silencing all silenceable outputs when its button is pushed.	The Point Active LED is lit if all silenceable outputs have been silenced. The Status (trouble) LED is lit if not all silenceable outputs have been silenced after the button is pushed.
RESET	... will act like the System Reset button on the panel, resetting the panel when its button is pushed.	No LED will ever light at this point.
DRILL	... will act like the Drill button on the panel, initiating a fire drill when its button is pushed.	The Point Active LED lights when the button is pushed and the system has entered the drill state. The Status (trouble) LED will never light.
ENABLE PAGING FROM —	...will cause the associated input to become an active audio source on Noti•Fire•Net. The user may then choose to activate specific PAM points on remote Digital Voice Commands to use this network input, or to perform a paging function such as ALL CALL from this input.	The Point Active LED is lit if a corresponding mapped point is active. The Status (trouble) LED is on when a point or zone is in trouble.
ALL CALL	This point will activate ALL CALL. (Speaker Circuits will turn on according to programming) to a DVC only. Mapping <i>must</i> be to a DVC node. If an AMG is connected to this panel, ALL CALL can be activated <b>ONLY</b> by the ALL CALL switch on the AMG. Do not program any other annunciators for ALL CALL.	The Point Active LED is lit if a corresponding mapped point is active. The Status (trouble) LED is on when a point or zone is in trouble.
PAGE INACTIVE	...will, when pressed after a Page Enable, allow PAGE INACTIVE paging from that source. The Special Paging Function map programming at the DVC will receive the page function.	The Point Active LED is lit if a corresponding mapped point is active. The Status (trouble) LED is on when a point or zone is in trouble.
PAGE EVAC	...will, when pressed after a Page Enable, allow Page Evac paging from that source. The Special Paging Function map programming at the DVC will receive the page function.	The Point Active LED is lit if a corresponding mapped point is active. The Status (trouble) LED is on when a point or zone is in trouble.
PAGE ALERT	...will, when pressed after a Page Enable, allow Page Alert paging from that source. The Special Paging Function map programming at the DVC will receive the page function.	The Point Active LED is lit if a corresponding mapped point is active. The Status (trouble) LED is on when a point or zone is in trouble.
FFT-NFN	...will, when pressed: <ul style="list-style-type: none"> <li>• Notify a DVC in the map format Nxxx,Nxxx,NxxxLyyMzzz or Nxxx,Nxxx,NxxxAyyT to open the FFT-NFN link and turn on the mapped FFT point or riser. A second press will notify the DVC to turn off that FFT point or riser and determine whether the FFT-NFN link should be closed or remain open.</li> <li>• Notify a DVC in the map format Nxxx,Nxxx to close or open the FFT-NFN link between two DVCs.</li> </ul>	The Point Active LED is lit if a corresponding mapped point is active. The Status (trouble) LED is on when a point or zone is in trouble.

**Table 3.5 ACS Point Mapping: Explanation of Point Modes (2 of 3)**

ACS Point Mode	Function: The point...	Explanation
CO MONITOR	... will show the current state of the CO element for the specified point entered.	The Point Active LED is lit if a corresponding mapped point is active. The Status (trouble) LED is on when a point is in trouble. This point is specifically used to annunciate the CO element of the PHOTO/CO detector.

**Table 3.5 ACS Point Mapping: Explanation of Point Modes (3 of 3)**



**CAUTION:**

WHEN A DISABLED OUTPUT IS ENABLED, IT WILL BE AFFECTED BY CONDITIONS EXISTING IN THE SYSTEM THAT WOULD NORMALLY AFFECT IT. FOR EXAMPLE, WHEN A CONDITION EXISTS IN THE SYSTEM THAT WOULD NORMALLY TURN THE OUTPUT ON, THE OUTPUT *WILL* TURN ON WHEN IT IS ENABLED.

**SOURCE :** Pressing this soft key will select the SOURCE field and also toggle between display formats if a point value is allowed. Enter a point or zone, or the panel's node number if the mode type is a system function such as acknowledge or reset.

Up to eight sources are allowed when CONTROL mode is chosen.

For ALL CALL, PAGE INACTIVE, PAGE EVAC, and PAGE ALERT modes, enter the node number of the DVC where the source is connected.

For TELEPHONE mode, enter the address of the telephone module point using the format NxxXLyyMzzz. Use the format NxxxAyyT (where xxx=the node number and yy = the digital audio amplifier address) for FFTs on risers that have no FTM modules installed.

FFT-NFN mode sources:

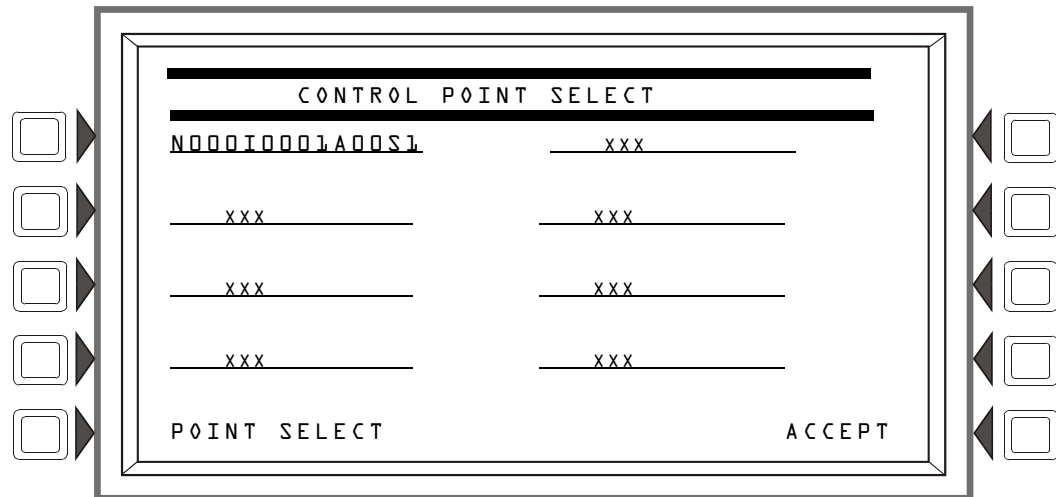
- format Nxxx,Nxxx,NxxxLyyMzzz: Telephone control module (NxxxLyyMzzz) preceded by the node numbers of the two DVCs (Nxxx,Nxxx) that will communicate over the FFT-NFN link.
- format Nxxx, Nxxx: numbers of the two DVCs that will communicate over the FFT-NFN link.
- format NxxxAyyT: Use this address (N = the DVC node number and A = the DAL device address on the digital audio loop) when no telephone control modules are installed on a DAL device's FFT riser.

Refer to the FFT-NFN section of the DVC manual for programming and application examples.

**ACCEPT :** Press this soft key to save the changes to the point displayed.

**BACK :** Press this soft key to exit the screen without saving, and return to the ACS Programming Screen.

## Control Point Select



**Figure 3.22 Control Point Select Screen**

Control source field entries may be:

- SLC modules in the format NxxxLyyMzzz. xxx = FACP node number, yy - the SLC loop number, zzz - module loop address.
- General zones in the format NxxxZyyy. xxx = FACP node number, yyy = General zone number (Z001 - Z999, not Z000. Zone 0 is not valid).



**NOTE:** A zone with a node number of zero (0) will be a local zone.

- Panel circuit modules in the format NxxxPyy.z. xxx = FACP node number, yy = panel circuit module number, z = panel circuit push button number.
- Prioritized Audio Matrix (PAM) speaker points, in the format NxxxIyyyyAzzSn. xxx = the DVC node number, yyyy = the input number in the PAM, zz = the DAA address on the Digital Audio Loop (01 through 32), and n = the DAA speaker circuit (1 through 4).



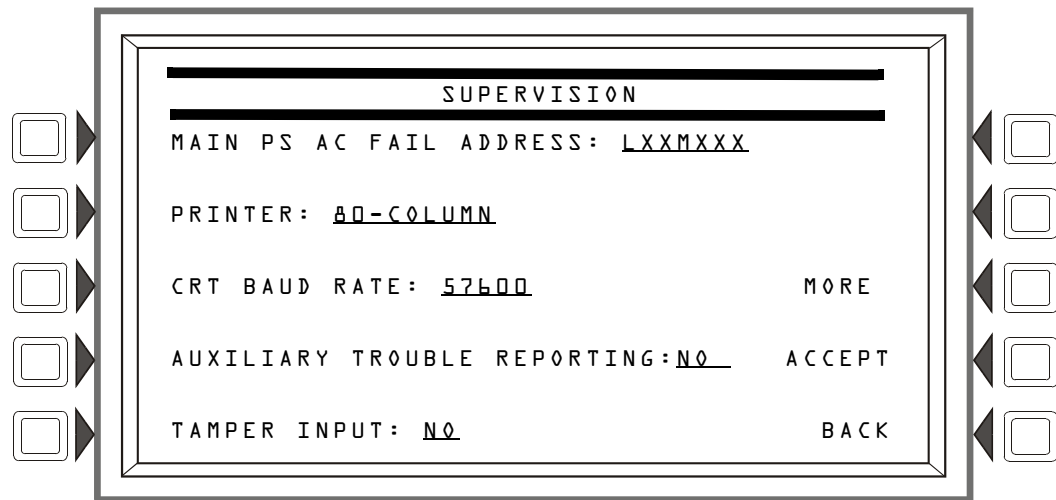
**CAUTION:** DO NOT MIX GENERAL ZONES WITH OTHER SOURCE TYPES FOR AN ACS CONTROL POINT. PROGRAM UP TO EIGHT GENERAL ZONES OR UP TO EIGHT OTHER CONTROL POINT TYPES.

### Soft Keys

All soft keys function like they do on the ACS Point Programming Screen.

### 3.2.9 Supervision

From the Panel Program Menu (1), select SUPERVISION to display the following screen.



**Figure 3.23 Supervision Screen**

#### Soft Keys

**MAIN POWER SUPPLY AC FAIL ADDRESS:** Press to enter the “Monitor AC Fail” (base plus one) address of the main power supply. Refer to the main power supply manual for complete addressing information. Enter the power supply address and press **ACCEPT**.

The LCD backlight will turn off when this power supply experiences AC failure (see **BACKLIGHT** in Section 3.2.7, “LCD Programming”, on page 31).

**PRINTER:** Press to scroll through the types of printer supervision: **NONE**, **40-COLUMN**, **40-COLUMN SUPERVISED**, **80-COLUMN**, **80-COLUMN SUPERVISED**, **40 GRAPHIC**, **80 GRAPHIC**, **80 GRAPHIC SUPERVISED**. The printer will not be active if **NONE** is selected. If a **SUPERVISED** selection is made, the printer will be supervised. Default: **NONE**



**NOTE:** When changing from an 80-column or 80-column supervised to an 80 graphic or 80 graphic supervised printer (or vice-versa), settings must be changed at the printer. Refer to this panel’s installation manual for the settings.

**CRT BAUD RATE:** Press to scroll through CRT baud rates. “SUP” after the rate indicates supervised. Select from: **4800**, **4800 SUP**, **9600**, **9600 SUP**, **19200**, **19200 SUP**, **38400**, **38400 SUP**, **57600**, **57600 SUP**. Default: **NONE**



**NOTE:** When LCD-80 Terminal Supervision is on (LCD-80 is selected at the MORE Supervision screen, see Figure 3.24 on page 39), CRT baud rate selections of 19200 and 57600 are disallowed.

**AUXILIARY TROUBLE REPORTING:** Press to toggle between Yes and No. Choose Yes if a trouble bus cable has been attached at J5 of the CPU2-3030. Default: **NO**

**TAMPER INPUT:** Press the soft key to toggle between **YES**, **NO**, and **AKS-1**.

**YES/NO reports (YES) or does not report (NO) a tamper situation at the panel cabinet door (as determined by an STS-1 tamper switch connected as shown in this panel’s installation manual).**

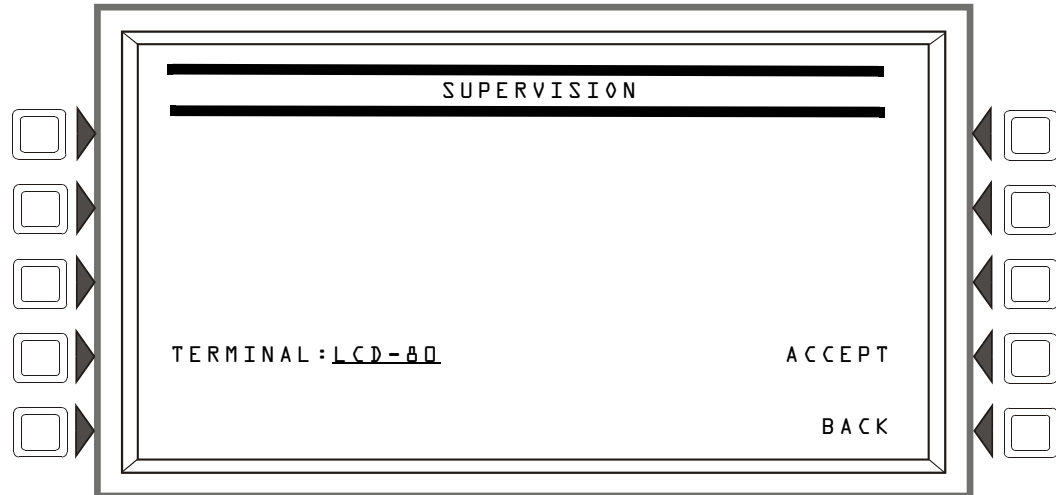
AKS-1 should be selected when there is an AKS-1 key switch connected to the panel cabinet door (which allows the operator to use Signal Silence, Reset, Drill and Acknowledge functions when a key turns the lock to “Enable”). Default: N0

M0RE : Press to bring up the second supervision screen.

ACCEPT : Press to save changes and return to previous menu.

### Supervision Screen (MORE)

This screen appears when M0RE is selected at the supervision screen.



**Figure 3.24 MORE Supervision Screen**

TERMINAL : Select NONE or LCD-80. (Default: NONE.) When LCD-80 is selected, LCD-160 programming is not allowed.



**NOTE:** When LCD-80 Terminal Supervision is on, CRT baud rate selections of 19200 and 57600 are disallowed.

### 3.3 Panel Program Menu (2)

Pressing the MORE soft key at PANEL PROGRAM MENU 1 displays the PANEL PROGRAM MENU 2 screen.

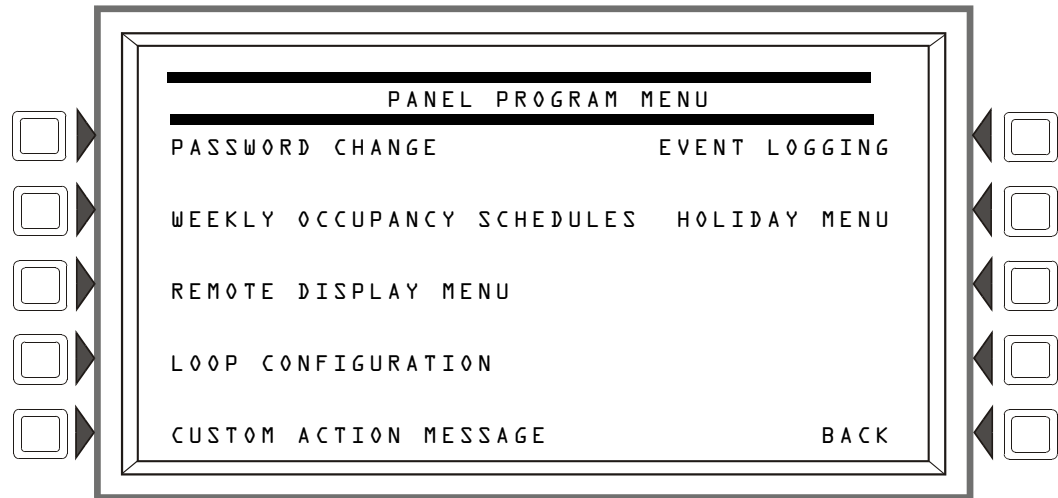


Figure 3.25 Panel Program Menu 2 Screen

#### Soft Keys

Press a soft key to bring up the associated menu.

#### 3.3.1 Password Change

Refer to paragraph “Password Change” on page 12 for information on password change.

#### 3.3.2 Weekly Occupancy Schedule

The user may specify up to ten different schedules; the one displayed when the screen is invoked is the one that is currently in effect.

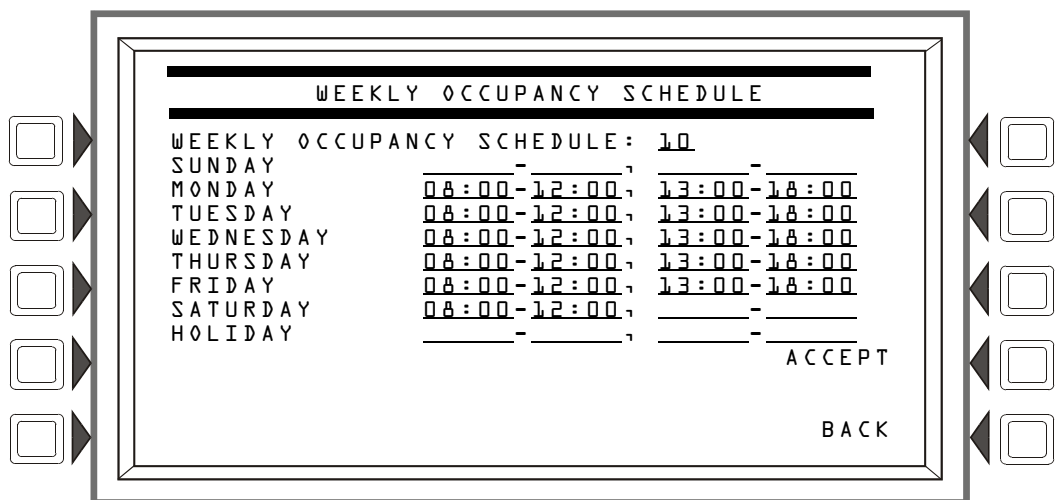


Figure 3.26 Weekly Occupancy Schedule Screen

Use the arrow keys on the keyboard to navigate between occupancy time fields: use the keypad to type in the time values.



**Soft Keys**

**WEEKLY OCCUPANCY SCHEDULE:** Press this soft key to toggle between schedules 1 - 10. A value of zero indicates no schedule.

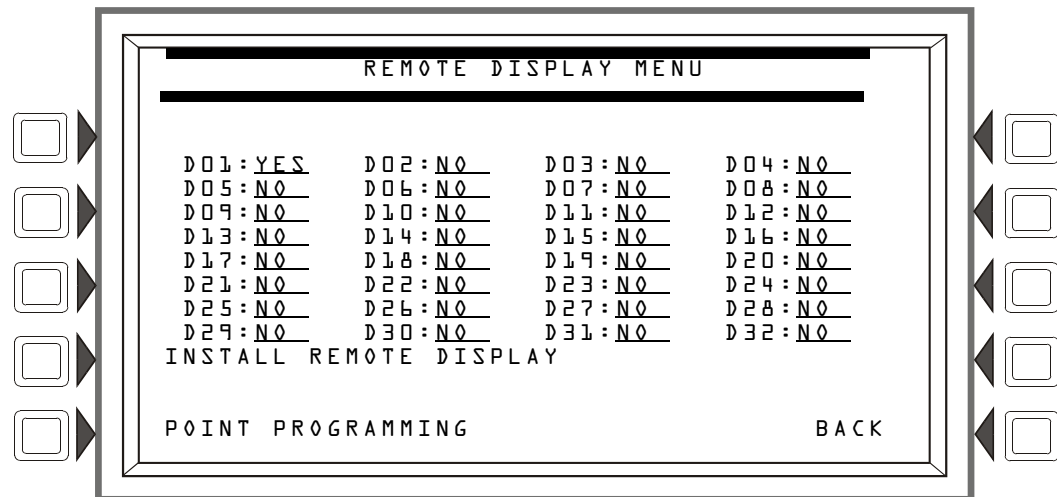
**ACCEPT:** Press this to save changes made on the screen.

**3.3.3 Remote Display Menu**

This screen displays when the **REMOTE DISPLAY MENU** soft key is pressed at the Panel Programming Menu 2 screen.



**NOTE:** To change the language of the remote display, or to program the panel banner to appear in the remote display, refer to Section 5.3.1, "LCD-160 Download Menu", on page 100.



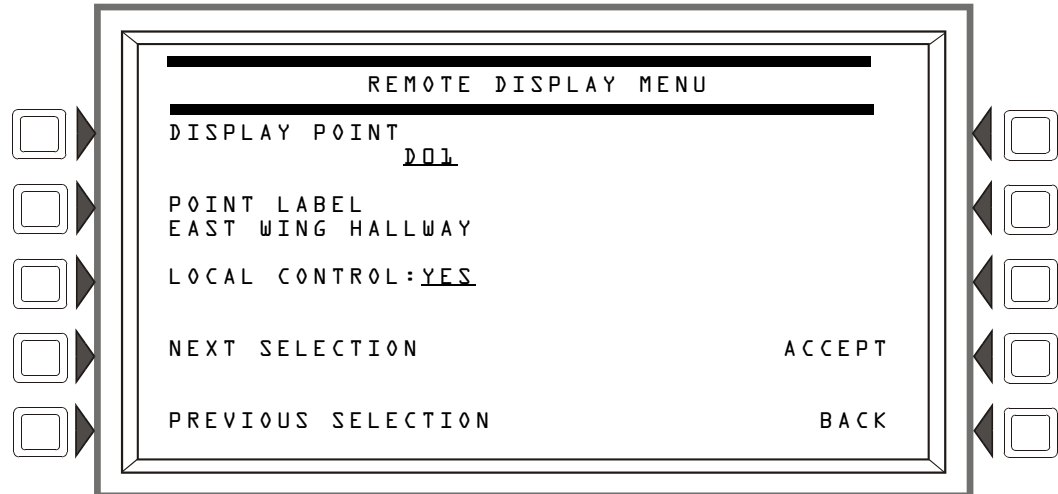
**Figure 3.27 Remote Display Menu Screen**

**Soft Keys**

**INSTALL REMOTE DISPLAY:** To install a remote display, press the arrow keys to place the cursor on the line next to the remote display address to be installed. Press this soft key until YES displays. Default: NO

**POINT PROGRAMMING:** Once a display has been installed, press this soft key to program the display point.

### Remote Display Point Programming



**Figure 3.28 Remote Display Point Programming Screen**

#### Soft Keys

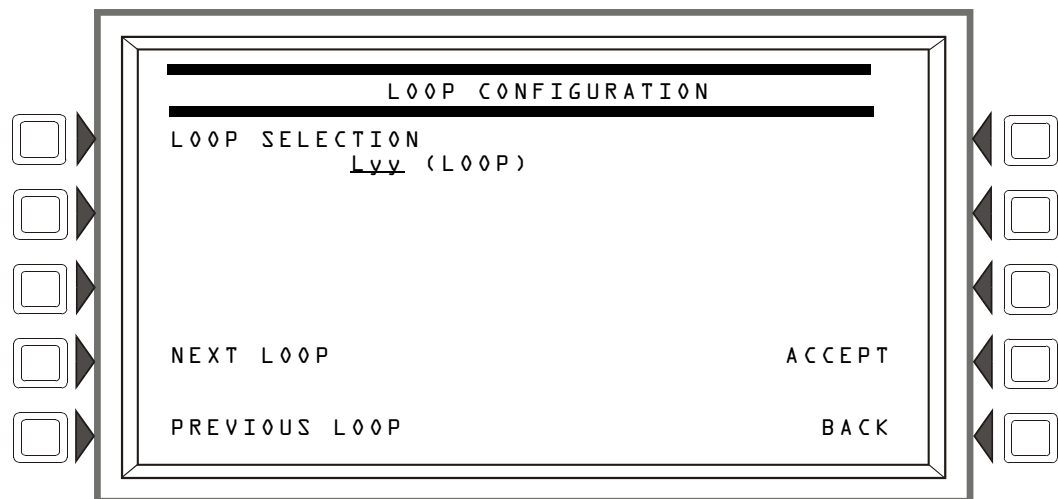
**DISPLAY POINT:** Press this soft key to bring the cursor to the underlined field. Use the keypad to type in the desired display address.

**POINT LABEL:** Press this soft key to bring the cursor to the underlined label field. Type in a label of up to 40 characters that will appear in trouble messages.

**LOCAL CONTROL:** Press to toggle between YES and NO. A setting of YES enables local control at the remote display.

### 3.3.4 Loop Configuration

This screen displays when the LOOP CONFIGURATION soft key is pressed at the PANEL PROGRAMMING MENU 2 screen. Here the programmer chooses one of the ten possible SLC loops for further definition.



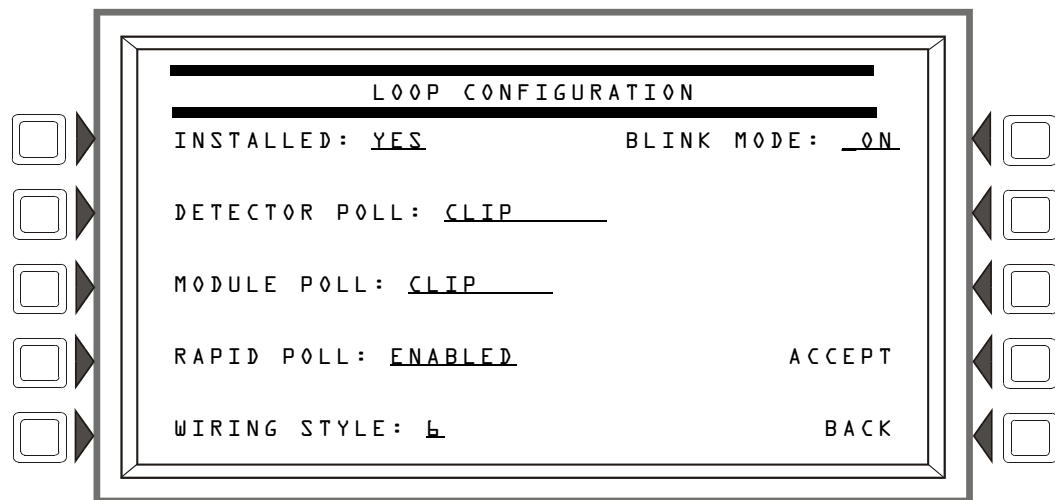
**Figure 3.29 Loop Configuration Screen**

**Soft Keys**

**LOOP SELECTION:** Pressing this soft key will invoke the cursor at the underlined field. Enter the loop number desired (01 through 10) in the yy of the Lyy format.

**NEXT/PREVIOUS SELECTION:** Press either key to go forward or back through the loop selections.

**ACCEPT:** Press to proceed to the Loop Point Programming screen.

**Loop Programming**

**Figure 3.30 Loop Programming Screen**

**Soft Keys**

**INSTALLED:** Press this soft key to choose YES or NO, depending on whether an SLC is installed at this address.

**DETECTOR POLL:** Press to select loop-polling mode. (See note below.)

**MODULE POLL:** Press to select loop-polling mode. (See note below.)

**NOTE:** FlashScan and CLIP Mode

Most FlashScan devices can be programmed to run in either CLIP or FlashScan mode. The types cannot be mixed on a loop: for example, if Loop 1 is programmed with a FlashScan module poll, CLIP modules may not be used on that loop.

A detector's LEDs will light a steady green for several seconds while it is subjected to a detector test during FlashScan polling. Each detector is tested this way on a regular basis. During the short time the LEDs are on steady, the detector is not providing fire protection.

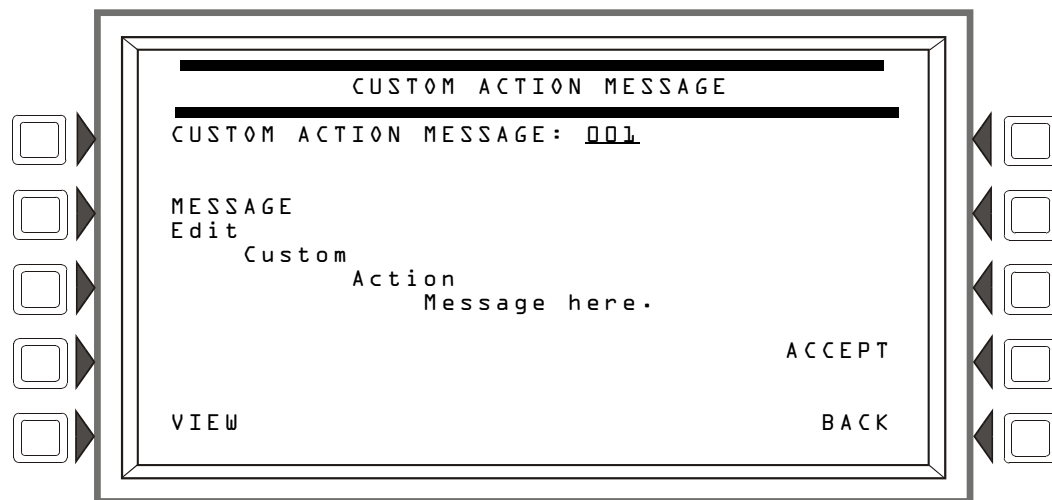
**RAPID POLL:** For CLIP mode only - enable or disable Rapid Poll for CLIP. This feature will poll the first 20 modules more often to speed response on manual pull stations.

**WIRING STYLE:** Press to select the NFPA wiring style (4 or 6) of the loop. If Style 6 is entered when the wiring is Style 4, a trouble message will be generated at the panel.

**BLINK MODE:** Press to enable (ON) or disable (OFF) detector LED blinking for this loop. If the Loop is configured in FlashScan mode with Blink Mode enabled, all detector and module LEDs will remain OFF. If the loop is configured in CLIP mode with Blink Mode enabled, the LEDs for detectors and monitor modules will remain OFF while the control modules operate normally.

### 3.3.5 Custom Action Message

A Custom Action Message appears when the MORE INFORMATION soft key is pressed when an event is displayed on the Event Counts screen. This panel supports up to 100 Custom Action Messages.



**Figure 3.31 Custom Action Message Screen**

**CUSTOM ACTION MESSAGE:** Enter a number with a value of 001 to 100 to display the corresponding Custom Action Message, or to add or edit a message.

**MESSAGE:** This soft key appears after VIEW is pressed. Press to enter/edit a custom message in the four lines indicated. The message may be up to 160 characters.

**VIEW:** Press this soft key to view the message that corresponds to the number entered in the underlined field.

**ACCEPT:** Press to save any change made to the message and return to the previous screen.



**NOTE:** A printout of all the messages may be obtained by entering the PRINT PROGRAMMING MENU (2) and pressing the CUSTOM ACTION MESSAGES soft key.

### 3.3.6 Event Logging

This menu gives the option of logging Non-fire Activations and Output Activations into a history file.

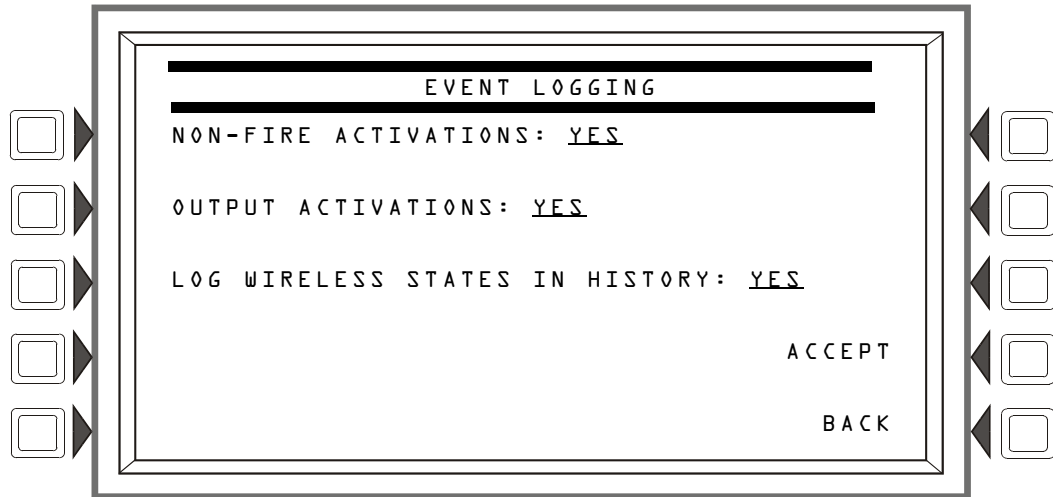


Figure 3.32 Event Logging Screen

Press the appropriate softkey to choose event logging (YES) and no event logging (NO). When YES is chosen, the activations are logged into history and printed.

### 3.3.7 Holiday Menu

This menu is used to create a list of up to 15 holidays, which are used together with the occupancy schedule to determine holiday occupancy hours. For example, the schedule displayed in Figure 3.26, “Weekly Occupancy Schedule Screen” on page 40, Schedule 10, has blank fields in the Holiday row. This Occupancy Schedule defines the schedule for the dates on the Holiday Menu screen below: there will be no occupancy hours on these dates.

The HOLIDAY Menu is displayed when the Holiday Menu soft key is pressed at the PANEL PROGRAMMING (2) Menu.

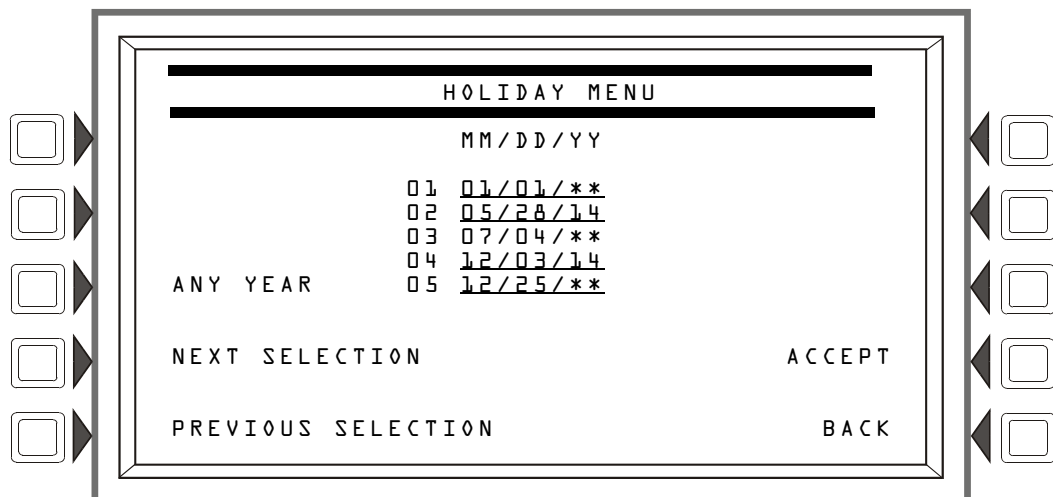


Figure 3.33 Holiday Menu Screen

The cursor will appear in the date fields, and may be moved using the keyboard arrow keys. Type to add/edit any holiday dates.

**Soft Keys**

**ANY YEAR** : Press to place asterisks in the YY section of the field. An asterisk denotes any year.

**NEXT/PREVIOUS SELECTION** : Press to view the next or previous group of five holidays.

**ACCEPT** : Press to save changes to the date fields and to return to the Panel Program Menu.

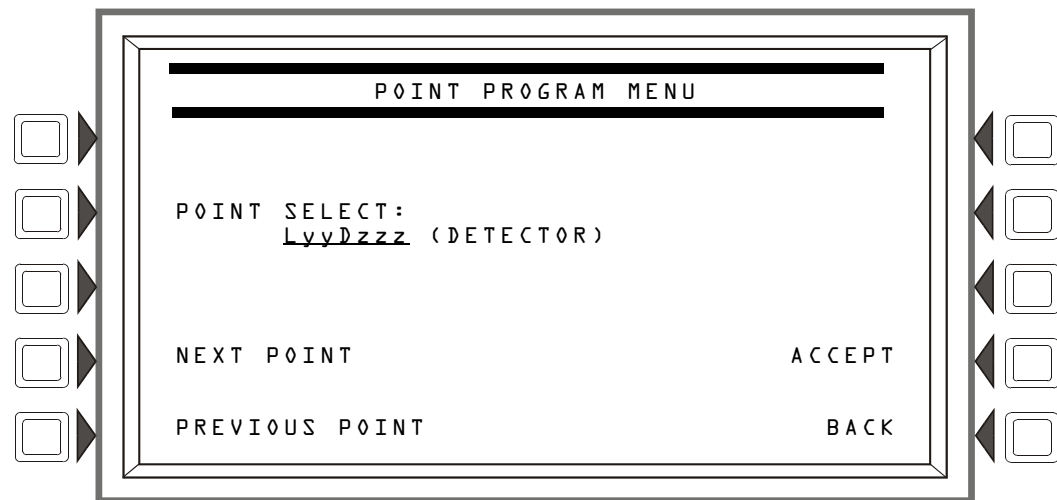
### 3.4 Point Program

The Point Program menu allows the programmer to enter/change point information for detectors, modules, and general, releasing, logic and trouble zones.

When programming points, take the following into design consideration:

- Each general zone must be dedicated to a single event type. (i.e. Fire, MN, Security, etc.)
- Map inputs only to general zones defined for the inputs event type. For example, map mass notification devices to general zones designated for mass notification.
- Outputs can be mapped to multiple general zones that are dedicated to different event types. For instance, a single output can be mapped to an MN general zone and a Fire general zone.

Press the Point Programming Menu soft key of the Program/Alter Status Menu to display the screen below.



**Figure 3.34 Point Program Menu**

**Soft Keys**

**POINT SELECT** : Press until the desired point type appears. The types - DETECTOR, MODULE, GENERAL ZONE, LOGIC ZONE, TROUBLE ZONE, ACS BOARD, or DAA or DVC - appear in the parenthesis after the point formats. Enter the desired point address in the format field. Formats are illustrated in Table 3.6.

Type	Address Format	
DETECTOR	LyyDzzz	L=Loop, yy=Loop number (1-10) D=Detector, zzz=Detector address (1-159)
MODULE	LyyMzzz	L=Loop, yy=Loop number (1-10) M=Module, zzz=Module address (1-159)
GENERAL ZONE	Zyyy	Z=Zone, yyy=Zone number (0-999)

**Table 3.6 Address Formats (1 of 2)**

Type	Address Format	
LOGIC ZONE	ZLyyyy	ZL=Logic Zone, yyyy=Logic Zone number(1-1000)
ANNUNCIATOR	Axx + Custom Label	A=Annunciator, Custom label
RELEASE ZONE	Ryy	R=Releasing Zone, yy=Releasing Zone number (00-09)
TROUBLE ZONE	ZTyyy	ZT=Trouble Zone, yyy=Trouble Zone number (1-100)
DVC/DAA	NxxxAAyy	N = Node, xxx=DVC or DVC-EM Node number, AA = DAA Audio Amplifier, yy=DAA address (01 through 32). Note: When yy=00, the address format is the DVC or DVC-EM address.

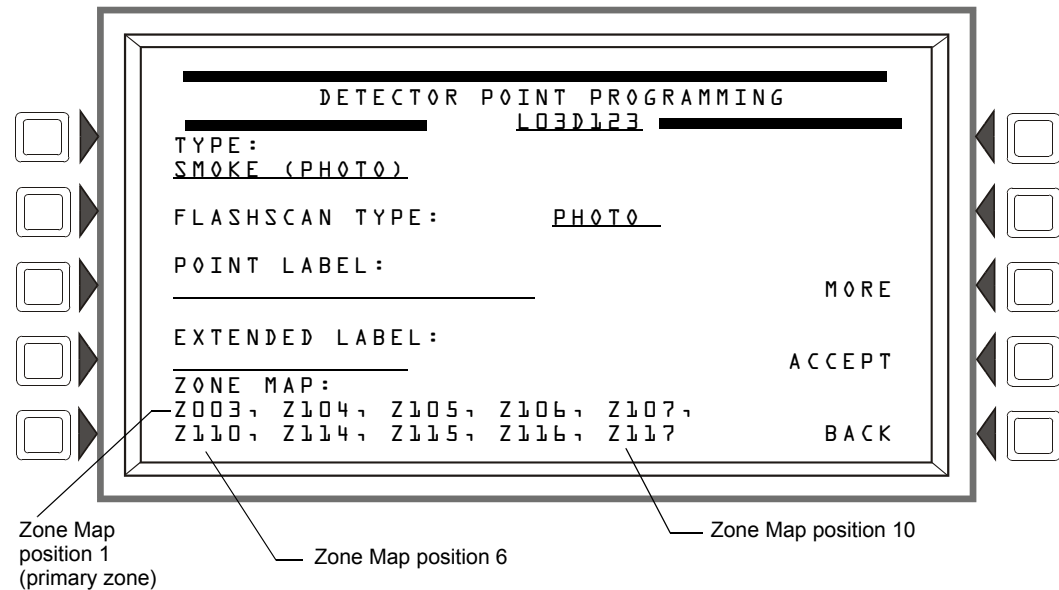
**Table 3.6 Address Formats (2 of 2)**

**ACCEPT:** Press to progress to the appropriate screen, based on the type of point selected.

**NEXT/PREVIOUS SELECTION:** Press to scroll backward or forward to the next or previously installed point.

### 3.4.1 Detector Point

This screen displays when a detector is chosen at the POINT PROGRAM menu (see Figure 3.34 on page 46).



**Figure 3.35 Detector Point Programming Screen**

The point address is displayed in line 3 of this screen. Existing point information is displayed in the fields.

#### Soft Keys

**TYPE:** Press this soft key to scroll through the point type choices: stop at the appropriate selection. If a new point is being added, no other field will be displayed until **TYPE:** is entered and the **ACCEPT** soft key is pressed. At this point, the rest of the fields will appear.

**FLASHSCAN CODE LABEL:** Press to scroll through a list of FlashScan Codes. Stop when the appropriate label appears (Table G.4 on page 159 for codes and descriptions). If the detector is not a FlashScan type, choose **NONE**.

**POINT LABEL:** Press this soft key to place the cursor at this field. Type in a 20-character maximum point label that will appear in message formats. If no entry is made, the field will default to the point address.

**EXTENDED LABEL :** Press to place the cursor at this field. Type in a 12-character maximum extended label to further define the location or nature of the point.

**ZONE MAP :** Displays the zones mapped to this point. During initial programming, zone map position one for each detector is set to Z0YY, where YY represents the loop number where the detector resides. In Figure 3.35 above, zone position one has a value of Z003 (YY = 03). The detector in the example resides on loop 3.

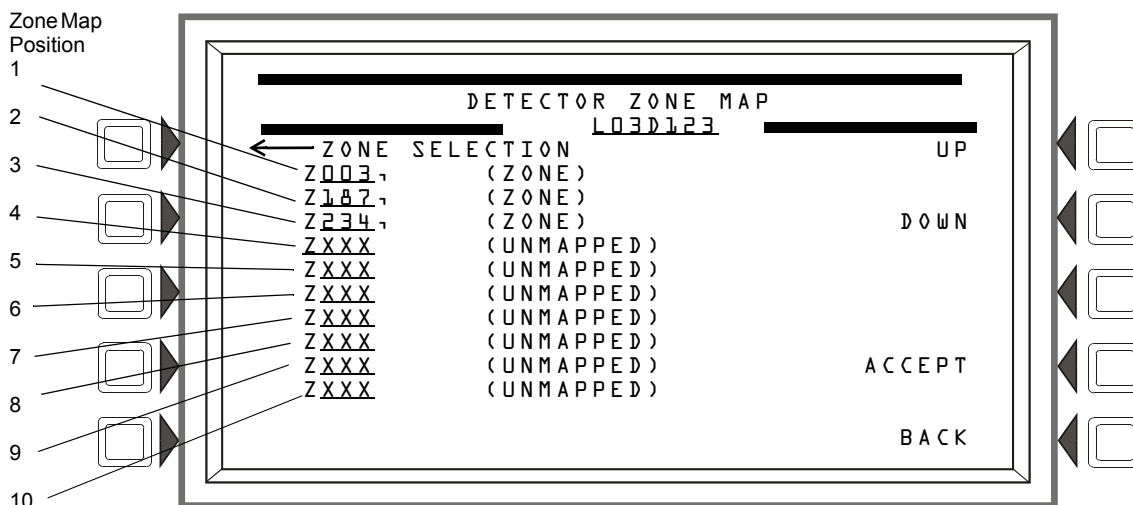
To add or delete zones for this point, press this soft key to progress to the Detector Zone Map screen.

**MORE :** Press this soft key to progress to the next detector point programming screen.

**ACCEPT :** Press to accept changes. If the user is adding a point, pressing this soft key after entering the TYPE field will display all the other fields.

### Zone Map

The Detector Zone Map screen will display when the ZONE MAP soft key is pressed at the Detector Point Programming screen.



**Figure 3.36 Zone Map (Detector Point) Screen**

When programming Zone Map for detectors, certain zone map positions are used for specific functions:

Zone Position:	Specific Function:
1	Use to link zone label to detector and for group zone disable.
3	<u>For Photo/CO detector only</u> -Activates when the photo element of the Photo/CO detector activates.
4	<u>For Photo/CO detector only</u> -Activates when the CO element of the Photo/CO detector activates. (Map the zone in this location to one of the Aux Controls of the intelligent sounder bases in order to play the Temp-4 tone for CO Alarms.)
5	<u>For Photo/CO detectors only</u> -Activates when the Photo/CO detector reports a CO Pre-Alarm.
9	Use to activate sounder/relay bases of FlashScan detectors.

**Table 3.7 Zone Position Special Functions**



Zone Position:	Specific Function:
10	Use for detectors set to Prealarm, Action

**Table 3.7 Zone Position Special Functions**

The point address will appear in line 3 of the screen.

Refer to Appendix E, “CBE: Zones and Equations”, on page 146, and Appendix C, “Special Zone Outputs”, on page 130 in this manual for more information about zones and how they apply to Control-By-Event.

### Soft Keys

**ZONE MAP:** A detector may be mapped to up to ten general, releasing, or special zones. There are ten positions available for mapping; positions 1, 3, 4, 5, 9, and 10 have additional functionality. (Refer to Figure 3.36)

Position 1 - Use this position to link the 20-character zone label to the detector. The zone label will appear after the 20-character label and 12-character extended label, providing a total of 52 characters to describe an event.

This position is checked when a group zone disable command is issued. If the zone number in the group zone disable command matches the zone number in the first position of the zone map, the detector point will be disabled.

Position 3 - (Photo/CO detector only) When the photo element of a Photo/CO detector reaches an Alarm threshold, the zone mapped in the third position will activate.

Position 4 - (Photo/CO detector only) When the CO element of a Photo/CO detector reaches an Alarm threshold, the zone mapped in the fourth position will activate. Use this zone to initiate a Temp-4 tone on an intelligent sounder base when a CO Alarm threshold is reached.

Position 5 - (Photo/CO detector only) When the CO element of a Photo/CO detector reaches a Prealarm threshold, the zone mapped in the fifth position will activate.

Position 9 -

- Use this position to activate the sounder/relay base of a detector. When this position is mapped to the same zone as Position 10, the sounder or relay base will be activated when the detector goes into prealarm (Action).
- Use this position to activate the sounder base of a detector using a general or a logic zone. When a general or logic zone activates, the panel is searched for any detector with the same zone mapped in its 9th position. The sounder base of any FlashScan detector that matches the search will activate.

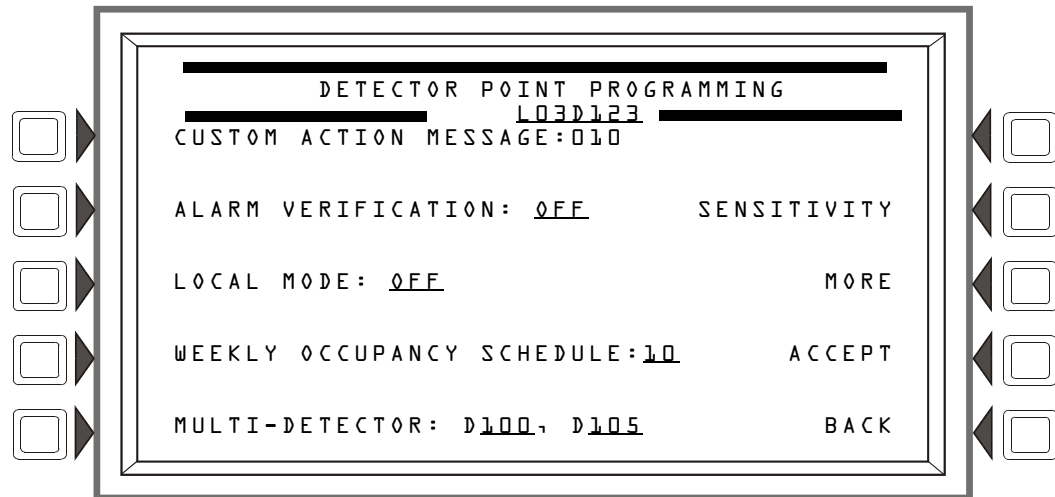
Position 10 - Use this position to map detectors with an “Action” Prealarm setting. The zone in the tenth position will activate when the detector reaches its Prealarm threshold; no other zones in this detector’s zone map will activate.

Move the cursor with the keyboard arrow keys to the appropriate zone map position, then select the type of zone by pressing the NEXT SELECTION (+) key until the desired zone type appears. Type in a zone number to map the detector to it.

**ACCEPT:** Press to save entries made on this screen and return to the Detector Point Programming screen.

## Detector Point Programming (2)

Press the **MORE** soft key on the Detector Point Programming screen to display this screen.



**Figure 3.37 More Detector Point Programming (2) Screen**

### Soft Keys

**CUSTOM ACTION MESSAGE:** Displays the custom action message number (a value of one through 100). The default value is 0 (no message). Press this soft key to progress to the Custom Action Message screen (Figure 3.38) to view the message or to choose a different message for viewing when this point activates. (To create a new custom action message, refer to Section 3.3.5, “Custom Action Message”, on page 44.)

**ALARM VERIFICATION:** Press this key to determine the device’s participation in Alarm Verification. Choosing Yes will set the device participation to the values entered at the Panel Timers screen (Figure 3.17).

**LOCAL MODE:** Press to toggle between Local Mode (ON) or no Local Mode (OFF). When there is a communication loss between the panel and its LCM/LEMs, SLC devices that have been selected for Local Mode participation (ON) will continue to function across all the panel’s SLCs in a limited manner as follows: input points will activate output points of the same Type Code point type designations. For example, SLC inputs with “fire” point types will activate SLC outputs with “fire” point types. Refer to Appendix G, “Type Codes”, on page 154 for type code point types. All SLC detector types can participate in local mode.



**NOTE:** The panel setting LCM LOCAL MODE must be set to YES for local mode to work at the device level.

**SENSITIVITY:** Press to proceed to the Detector Sensitivity screen.

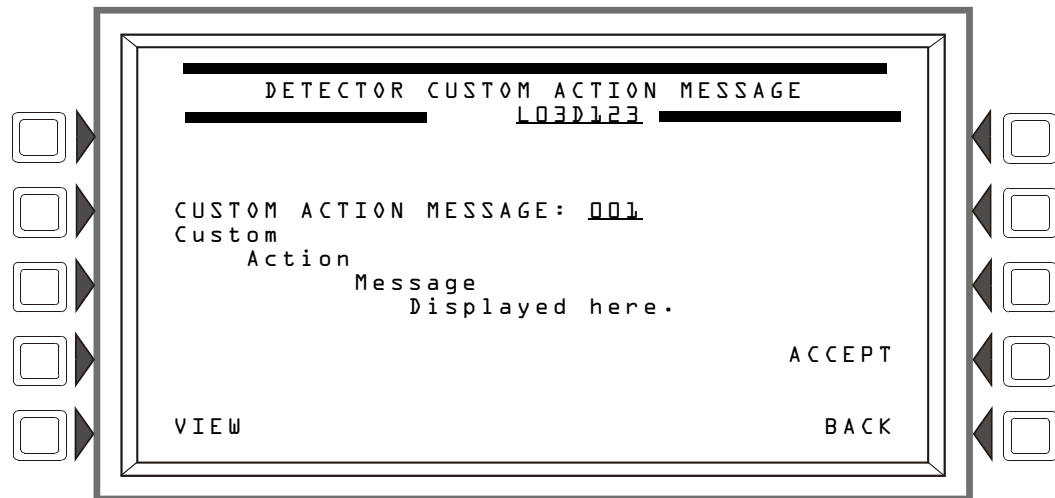
**WEEKLY OCCUPANCY SCHEDULE:** To choose an existing weekly occupancy schedule, press this soft key to proceed to the Detector Occupancy Schedule screen. Refer to Section 3.3.2, “Weekly Occupancy Schedule”, on page 40 for information on how to set up a schedule.

**MULTI-DETECTOR:** This detector can be linked with up to two detectors at other addresses on the same loop in cooperative multi-detector sensing if entries are made in these fields. The detectors need not be sequential in their addresses. Refer to the section on Cooperative Multi-Detector Sensing in Appendix D, “Intelligent Sensing Applications” for a description of this function.

**MORE:** Press this soft key to progress to the next detector point programming screen.

### Custom Action Message

Press the Custom Action Message soft key on the Detector Point Programming screen to display this screen. The user may choose a Custom Action Message at this screen.



**Figure 3.38 Custom Action Message Screen**

#### Soft Keys

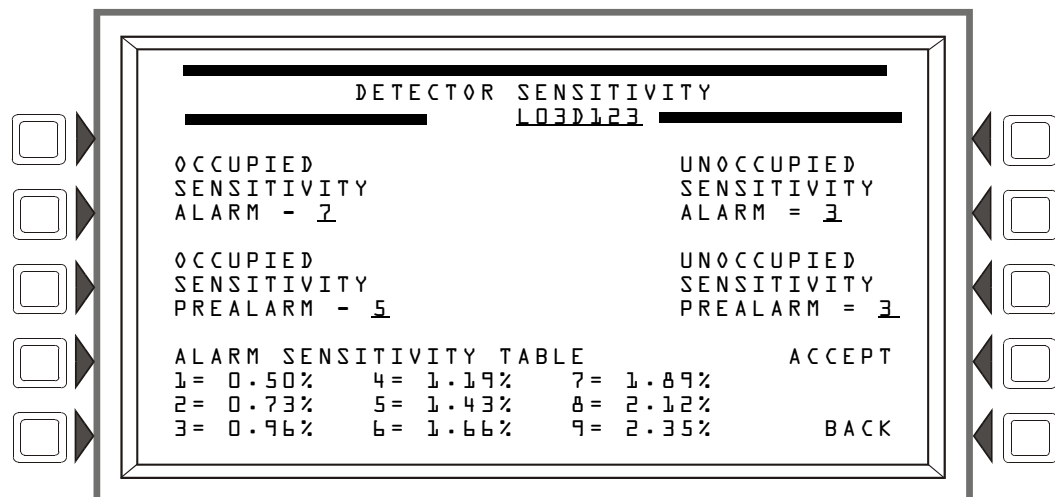
**CUSTOM ACTION MESSAGE:** Enter the number of the Custom Action Message to be displayed during alarm conditions for this point (refer to Figure 3.31 on page 44 for an example).

**VIEW:** Press this soft key to view the message associated with the number entered.

**ACCEPT:** Press to save the entries made on this screen.

#### ■ Sensitivity

Detector sensitivity levels for alarm and prealarm are set at this screen, which displays when the SENSITIVITY soft key is pressed at the Detector Point Programming (2) screen.



**Figure 3.39 Detector Sensitivity Screen**

The control panel provides nine levels of Prealarm and Alarm in percent per foot obscuration, with the following exceptions:

- for heat detectors, the settings are in degrees Centigrade.

- for beam detectors, there are only six levels of Alarm. There is no Prealarm for beam detectors in CLIP mode.
- for IntelliQuad FSC-851 and IntelliQuad Plus FCO-851 detectors, there are only six levels of Alarm and Prealarm for FlashScan mode, The sixth level is a fixed 135°F, and it is not available in CLIP mode.

Alarm sensitivity settings range from one to nine, with one representing the most sensitive alarm level and nine the least sensitive.

Prealarm sensitivity settings range from zero to nine. Zero indicates no prealarm. A value of one can be a self-optimizing setting where the control panel selects a suitable prealarm level for the detector. Values one or two through nine represent decreasing sensitivity, with nine being the least sensitive.

Refer to the section “Detector Sensitivity Settings” in Appendix D, “Intelligent Sensing Applications” for a full description and a table of the nine sensitivity levels by detector type.

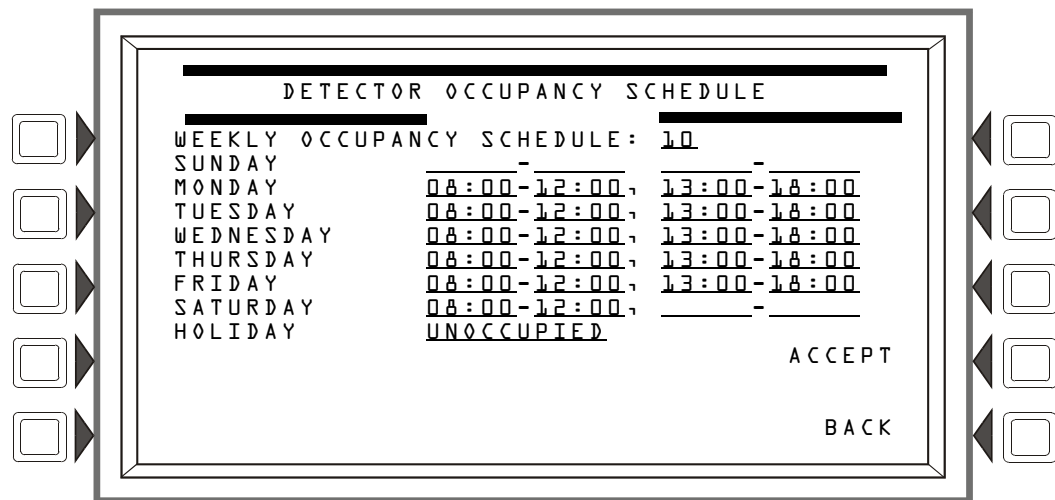
**Soft Keys**

- OCCUPIED SENSITIVITY ALARM:
- OCCUPIED SENSITIVITY PREALARM:
- UNOCCUPIED SENSITIVITY ALARM:
- UNOCCUPIED SENSITIVITY PREALARM:

Press the soft key next to these setting categories to enter values as described above.

ALARM SENSITIVITY TABLE: This table will toggle from ALARM to PREALARM based on which sensitivity value is being entered. The table will display the values for this type of detector.

■ **Detector Occupancy Schedule**



**Figure 3.40 Detector Occupancy Schedule Screen**

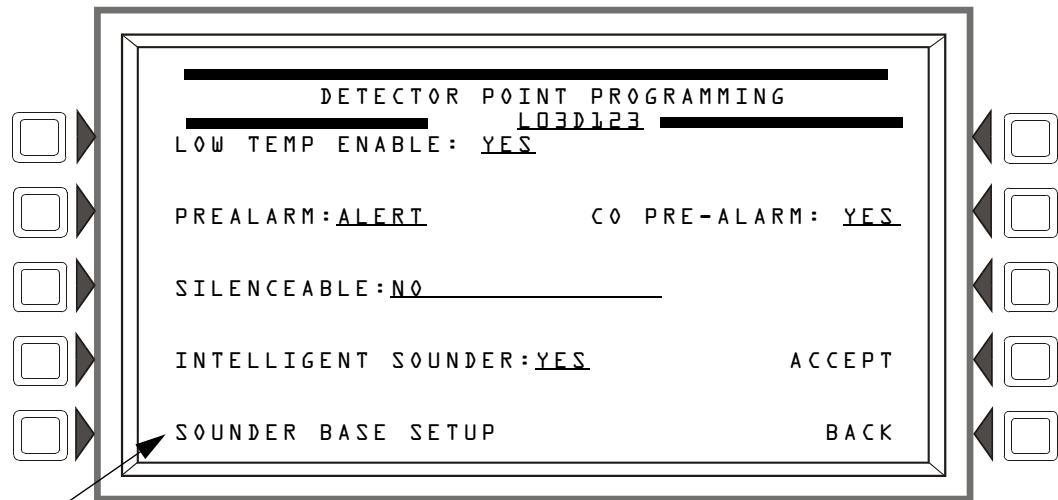
**Soft Keys**

WEEKLY OCCUPANCY SCHEDULE: Press this soft key to place the cursor at the underlined field. There can be up to ten Weekly Occupancy Schedules. Enter a value of zero through ten. Zero indicates no schedule is applied, and occupied detector sensitivity values are used.

ACCEPT: Press this key to accept the change made and return to the previous screen.

### Detector Point Programming (3)

Press the MORE soft key on the Detector Point Programming (2) screen to display this screen.



When programming an aspiration detector, this position will be replaced by "REFERENCE DETECTOR ADDRESS".

**Figure 3.41 More Detector Point Programming (3) Screen**

#### Soft Keys

**LOW TEMP ENABLE:** Press this softkey to select YES or NO to enable the Low Temperature Warning for the PHOTO/CO detector. This field is only available when programming a PHOTO/CO smoke detector.

**PREALARM:** Press this softkey to select ALERT or ACTION for the Prealarm function. Refer to the section on Prealarm in Appendix D, "Intelligent Sensing Applications" for a description of Alert and Action.

**SILENCEABLE:** This field determines whether the user can manually silence a detector's activated sounder/relay base. Values are as follows:

NO	Not manually silenceable	
YES - RESOUND FIRE	Silenceable, resound on fire alarm events	Network and Local Resound
YES - RESOUND SUPERV	Silenceable, resound on supervisory events	Network and Local Resound
YES - NO RESOUND	Silenceable, does not resound	



**NOTE:** In network applications, specific nodes can be excluded from having the ability to initiate a resound on the local fire alarm panel. This is programmable via VeriFire Tools. Refer to the *VeriFire Tools help file*.

**INTELLIGENT SOUNDER:** Press this softkey to select YES if an Intelligent Sounder Base is installed for this detector.

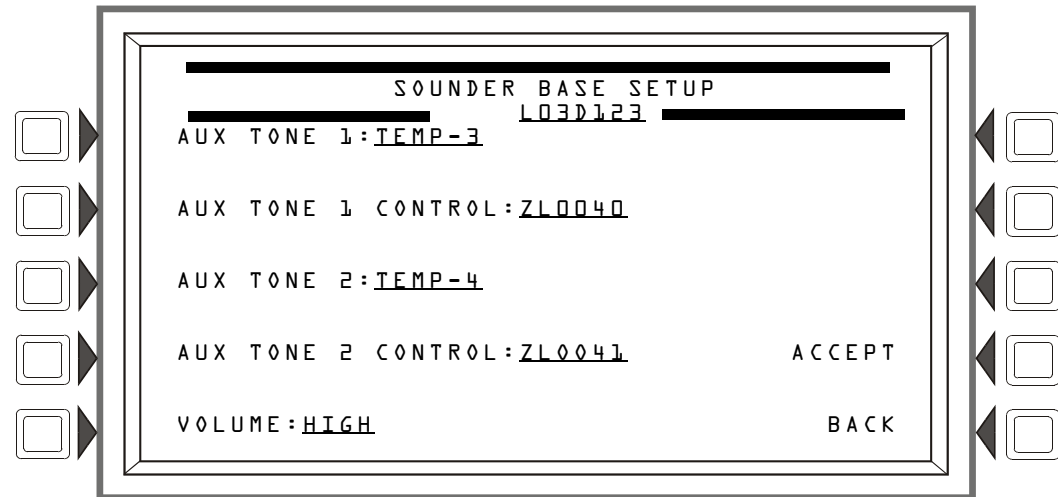
**SOUNDER BASE SETUP:** Press this softkey to proceed to the Sounder Base Setup screen. This option will only be available if the INTELLIGENT SOUNDER is set to YES.



**NOTE:** When programming an aspiration detector, INTELLIGENT SOUNDER is not an option and SOUNDER BASE SETUP is replaced by REFERENCE DETECTOR ADDRESS.

**CO PRE-ALARM:** Press this softkey to select YES or NO to enable the CO Prealarm function for the PHOTO/CO smoke detector. This field is only available when programming the PHOTO/CO smoke detector.

### ■ Sounder Base Setup



**Figure 3.42 Sounder Base Setup Screen**

#### Soft Keys

**AUX TONE 1:** Press this softkey to select CONTINUOUS, TEMP-3, TEMP-4, MARCH or CUSTOM for the first auxiliary tone of the intelligent sounder base.

**AUX TONE 1 CONTROL:** Press this softkey to enter the Logic, General or Trouble Zone that will control the activation of the first auxiliary tone of the intelligent sounder base.

**AUX TONE 2:** Press this softkey to select CONTINUOUS, TEMP-3, TEMP-4, MARCH or CUSTOM for the second auxiliary tone of the intelligent sounder base.

**AUX TONE 2 CONTROL:** Press this softkey to enter the Logic, General or Trouble Zone that will control the activation of the second auxiliary tone of the intelligent sounder base.

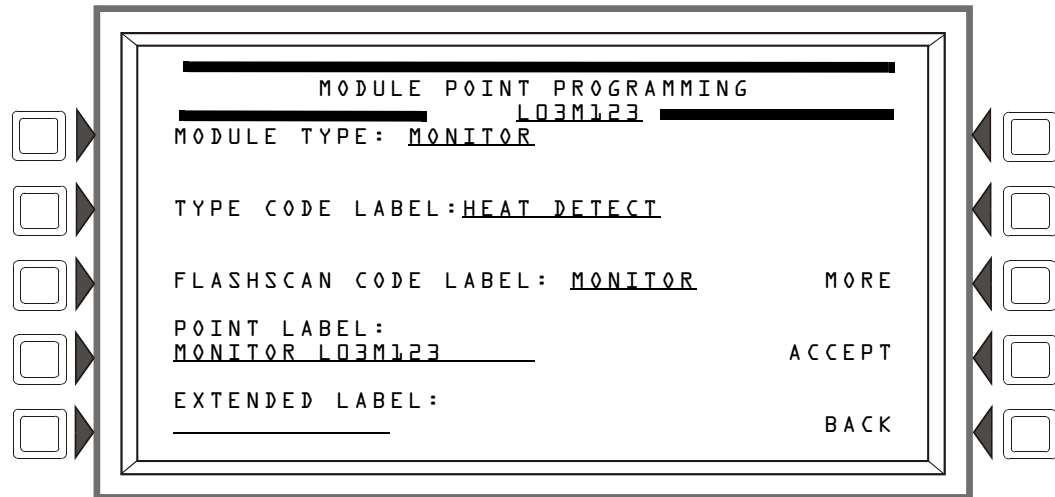
**VOLUME:** Press this softkey to select LOW or HIGH for the intelligent sounder base volume level.

For CUSTOM TONE SETUP, refer to “Custom Tone Setup Screen” on page 26.

## 3.4.2 Module Point

Module point programming screens will display if a module point address is entered at the Point Programming Menu (see Figure 3.34 on page 46).

### Module Point Programming (1)



**Figure 3.43 Module Point Programming (1) Screen**

#### Soft Keys

**MODULE TYPE:** Press the soft key to toggle between `CONTROL` and `MONITOR`.

**TYPE CODE LABEL:** Press this soft key to scroll through the point type choices: stop at the appropriate selection.

**FLASHSCAN CODE LABEL:** Press this soft key to scroll through the point type choices: stop at the appropriate selection (Table G.4 on page 159 for codes and descriptions). Choose `NONE` if the point type is not FlashScan.



**NOTE:** If the point is not installed, `MODULE TYPE:`, `TYPE CODE LABEL:`, and `FLASHSCAN CODE LABEL:` must be entered before any entries can be saved using the `ACCEPT` key.

**POINT LABEL:** Press this soft key to place the cursor at this field. Type in a 20-character maximum point label that will appear in message formats. If no entry is made, the field will default to the point address.

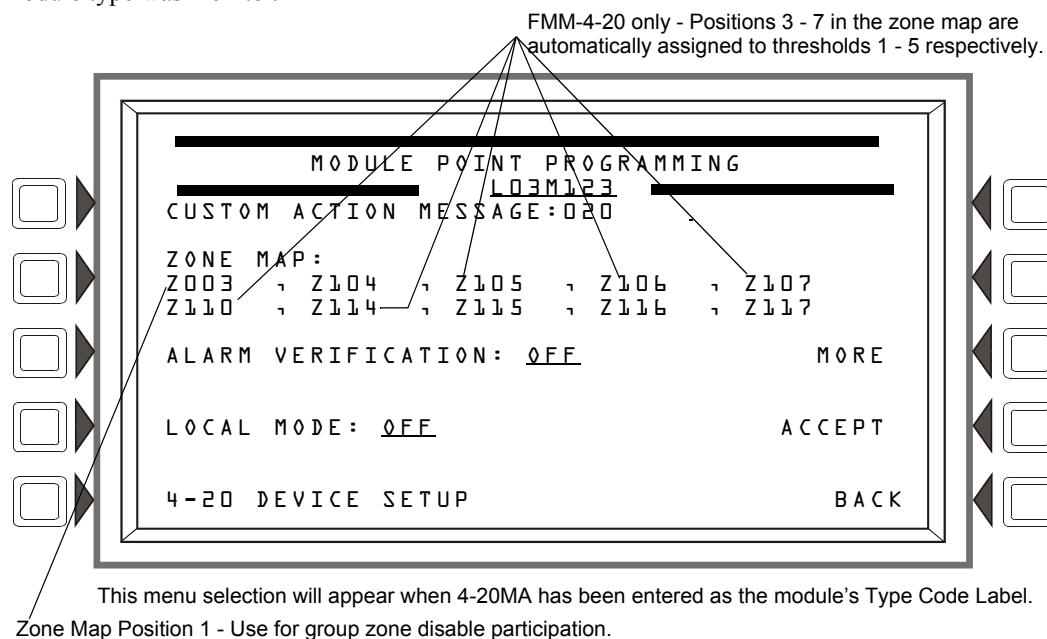
**EXTENDED LABEL:** Press to place the cursor at this field. Type in a 12-character maximum extended label to further define the location or nature of the point.

**MORE:** Press to proceed to the next screen for more point programming.

**ACCEPT:** Press to save entries made on this screen.

## Module Point Programming (Monitor Module)

Pressing the MORE soft key at the Module Point Programming screen will display this screen if the module type was monitor.



**Figure 3.44 Module Point Programming Screen 2 (Monitor)**

### Soft Keys

**CUSTOM ACTION MESSAGE:** Displays the custom action message number (a value of one through 100). The default value is 0 (no message). Press this soft key to progress to the Custom Action Message screen (shown in Figure 3.38) to view the message or to choose a different message for viewing when this point activates. To create a new custom action message, refer to Section 3.3.5, “Custom Action Message”, on page 44.

**ZONE MAP:** Displays the zones mapped to this point. During initial programming, zone map position one for each monitor module is set to Z0YY, where YY represents the loop number where the module resides. In Figure 3.44 above, zone position one has a value of Z003 (YY = 03). The module in the example resides on loop 3.

To add or delete zones, press this soft key to proceed to the Module Zone Map screen. Refer to “Zone Map” on page 48 for an illustration and explanation of the Detector Zone Map screen. The Module Zone Map screen is the same except that Module replaces Detector in the title and the module address appears instead of the detector address. Up to ten general, releasing or special zones may be mapped to a monitor module: none of the zone map positions are fixed. Positions 1 and 3 - 7 have additional functionality.

**Position 1** - This position is checked when a group zone disable command is issued. If the zone number in the group zone disable command matches the zone number in the first position of the zone map, the module point will be disabled.

**Positions 3 - 7** - For the FMM-4-20 module only. These positions are assigned to FMM-4-20 threshold levels 1 - 5 respectively. (Threshold levels are user-programmed. Refer to “FMM-4-20 Monitor Module Programming” on page 57.) Each will activate only if the device is currently at that threshold level. Once the device leaves that threshold level, the zone in its corresponding CBE position will remain active or deactivate according to whether its threshold is programmed for latching or tracking.

**ALARM VERIFICATION:** Press this key to determine participation in Alarm Verification. Choosing Yes will set the device participation to the value entered at the Panel Timers screen (Figure 3.17). The only module type that can participate in alarm verification is the FZM-1.



**LOCAL MODE :** Press to toggle between Local Mode (0N) or no Local Mode (0FF). When there is a communication loss between the panel and its LCM/LEMs, SLC devices that have been selected for Local Mode participation (0N) will continue to function across all the panel's SLCs in a limited manner as follows: input points will activate output points of the same Type Code point type designations. For example, SLC inputs with "fire" point types will activate SLC outputs with "fire" point types. Refer to Appendix G.3, "Type Codes for Input Devices", on page 154 for Type Code point types. This setting is fixed at 0FF for the FMM-4-20 module. Default: 0FF



**NOTE:** The panel setting LCM LOCAL MODE must be set to YES for local mode to work at the device level.

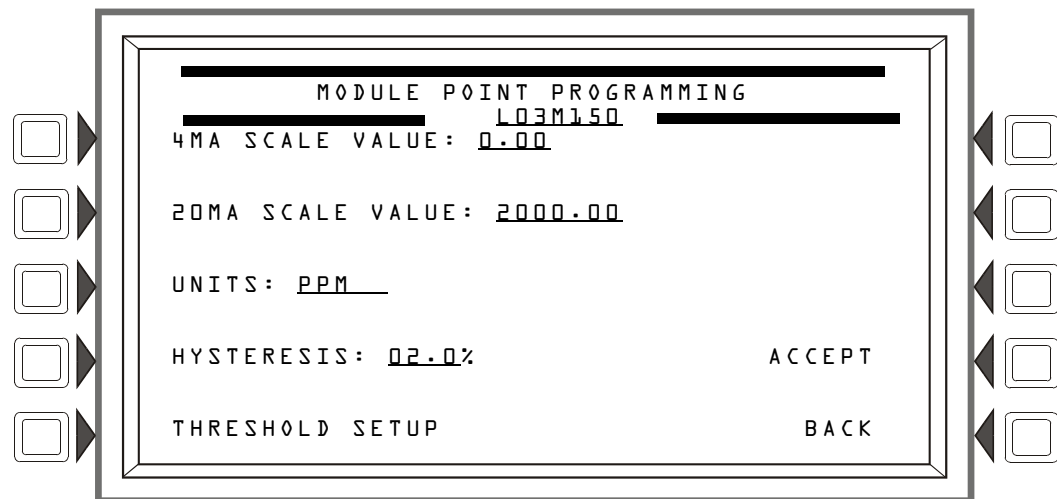
**4-20 DEVICE SETUP :** Press to go to FMM-4-20 programming. (Refer to "FMM-4-20 Monitor Module Programming" on page 57 "FMM-4-20 Monitor Module Programming" on page 57) This field appears only when FMM-420 appears as the module's Type Code label.

**MORE :** Press to access the third Module Point Programming Screen.

**ACCEPT :** Press to save entries made on this screen and to return to the previous screen.

### ■ FMM-4-20 Monitor Module Programming

Pressing the 4-20 DEVICE SETUP soft key at the Module Point Programming screen will display this screen.



**Figure 3.45 FMM-4-20 Device Setup Screen**

#### Soft Keys

**4MA SCALE VALUE :** Enter the 4 mA value.

**20MA SCALE VALUE :** Enter the 20 mA value.

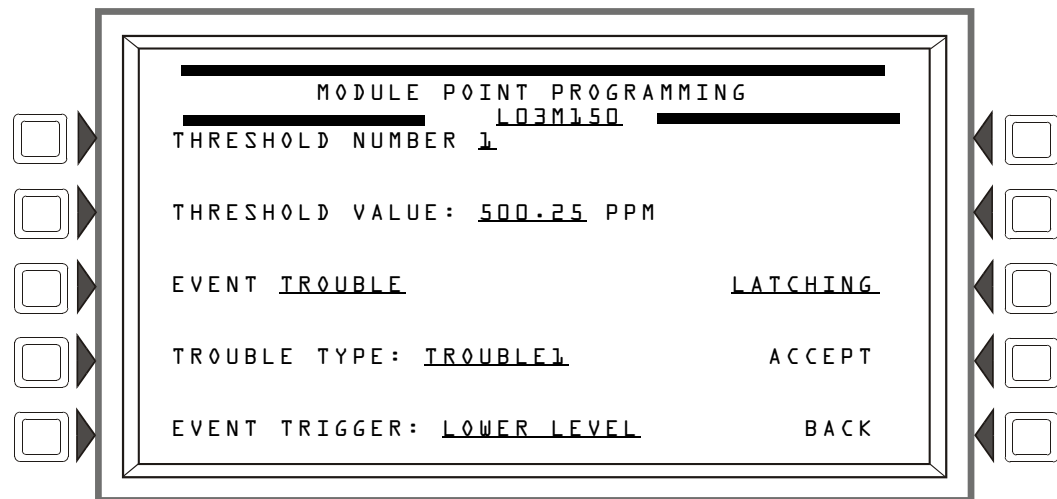
**UNITS :** Type in the kind of units. (5 spaces.)

**HYSTERESIS :** Enter the hysteresis value in decimals as a percentage of the overall 4 to 20 mA range. Default: 0

**THRESHOLD SETUP :** Press to continue to the THRESHOLD SETUP screen. (Refer to Figure 3.46 on page 58)

**ACCEPT :** Press to save entries made on this screen.

Pressing the THRESHOLD SETUP soft key at the Module Point Programming screen will display this screen.



**Figure 3.46 FMM-4-20 Threshold Setup Screen**

### Soft Keys

**THRESHOLD NUMBER** : Enter the threshold number (1 - 5) that will be described in this screen.

**THRESHOLD VALUE** : Enter the value for this threshold. (Threshold value is represented in the unit type specified on the FMM-4-20 Device Setup Screen)

**EVENT** : Select the event type that will generate when this threshold is reached. Selections are **NO EVENT**, **TROUBLE**, **FIRE**, **SUPERVISORY**, **SECURITY**, **NONFIRE**, **CRITICAL PROCESS**.

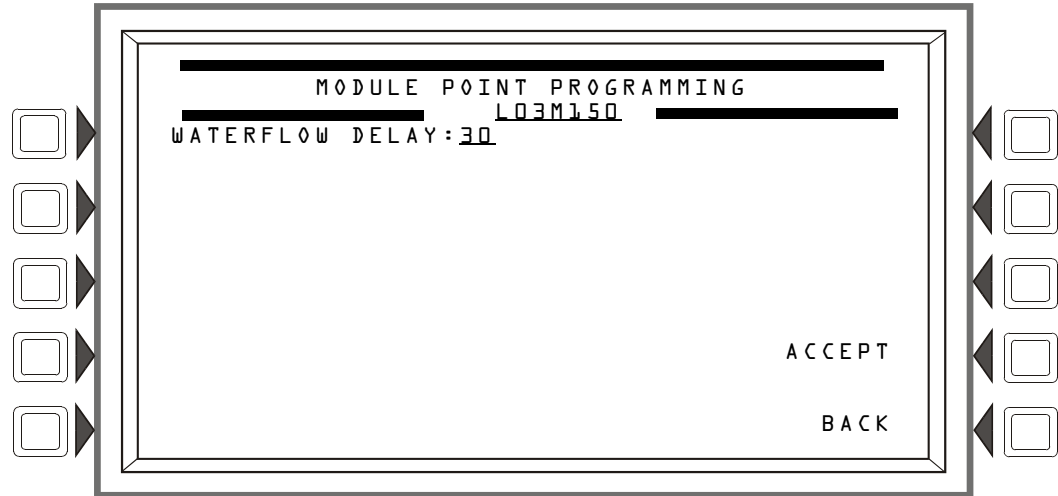
**TROUBLE TYPE** : Select a trouble type for this threshold: **TROUBLE 1**, **TROUBLE 2** or **DEVICE INHIBIT**. Device Inhibit will generate a trouble when the FMM-4-20 is in a self-calibration state.

**EVENT TRIGGER** : Select **LOWER LEVEL** (values are falling), **UPPER LEVEL** (levels are rising), or **SAME LEVEL**.

**TRACKING/LATCHING** : Select **TRACKING** or **LATCHING** for the threshold trouble. If more than one threshold has been programmed as latching, the first threshold reached will be the one that is latched.

**ACCEPT** : Press to save screen entries.

Pressing the MORE soft key on this Module Point Programming screen will display this screen:



**Figure 3.47 Module Point Programming Screen 3 (Monitor)**

**WATERFLOW DELAY:** When the **WATERFLOW DELAY** option is set to 0, waterflow events are immediately reported to the panel upon activation. If a non-zero value is entered in the **WATERFLOW DELAY**, activation of a waterflow event is delayed for the duration of that time. The waterflow event will have to remain active for the duration of the delay. If the waterflow event does not remain active for the entire delay duration, the waterflow event will not be reported to the panel.

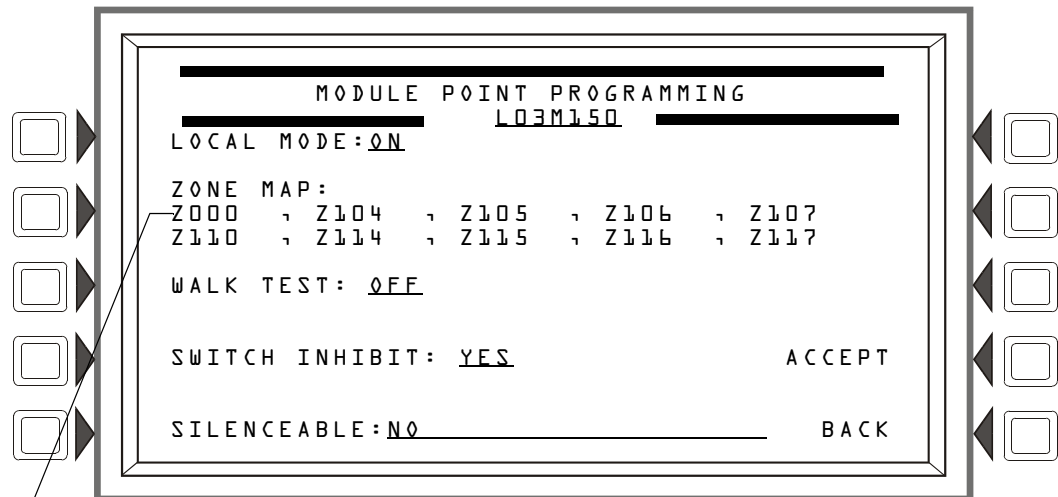
Default: 0

Range: 0 - 60 seconds

**ACCEPT:** Press to save screen entries.

**Module Point Programming (Control Module)**

Pressing the MORE soft key at the Module Point Programming screen will display this screen if the module type was control.



Zone Map Position 1 - Use for group zone disable participation.

**Figure 3.48 Module Point Programming Screen 2 (Control)**

## Soft Keys

**LOCAL MODE** : Press to toggle between Local Mode (0N) or no Local Mode (0FF). When there is a communication loss between the panel and its LCM/LEM, SLC devices that have been selected for Local Mode participation (0N) will continue to function across all the panel's SLCs in a limited manner as follows: input points will activate output points of the same Type Code point type designations. For example, SLC inputs with "fire" point types will activate SLC outputs with "fire" point types. Refer to Appendix G.3, "Type Codes for Input Devices", on page 154 for Type Code point types. Default: 0FF



**NOTE:** The panel setting LCM LOCAL MODE must be set to Yes for local mode to work at the device level.

**ZONE MAP** : Displays the zones mapped to this point. The default value assigned to control modules during initial programming is Z000 at Position 1 (refer to Figure 3.48), with the exception of control modules with the following Type IDs: TELEPHONE, GEN ALARM, GEN SUPERVIS, GEN TROUBLE, and TROUBLE PEND.

To add or delete zones, press this soft key to proceed to the Module Zone Map screen. Refer to "Zone Map" on page 48 for an illustration and explanation of the Detector Zone Map screen. The Module Zone Map screen is the same except that Module replaces Detector in the title and the module address appears instead of the detector address. Up to ten general, logic, release, special or trouble zones may be mapped to a control module. Position 1 has additional functionality.

Position 1 - This position is checked when a group zone disable command is issued. If the zone number in the group zone disable command matches the zone number in the first position of the zone map, the module point will be disabled.

Note that the group zone disable command has no effect on general alarm zone Z000.

**WALK TEST** : This field determines if the output will activate during Walk Test. Values are 0N (the output will activate) and 0FF (the output will not activate). Default: 0FF.



**NOTE:** The following Type ID codes do not participate in Walk Test, and the WALK TEST soft key will not appear when the screen displays: REL END BELL, RELEASE CKT, REL CKT ULC, REL FORM C, REL AUDIBLE, INST RELEASE, NONRESET CTL, TELEPHONE, and FORM-C RESET. The FMM-1 module with SMOKE CONV, HEAT DETECT, or SMOKE DETECT does not participate in Walk Test.

**SWITCH INHIBIT** : This field determines whether a user can manually activate an output. Values are YES (can not be activated manually) or NO (can be activated manually). Default: NO

**SILENCEABLE** : This field determines whether the user can manually silence an activated output. Values are as follows:

NO	Not manually silenceable	
YES - RESOUND FIRE	Silenceable, resound on fire alarm events	Network and Local Resound
YES - RESOUND SUPERV	Silenceable, resound on supervisory events	Network and Local Resound
YES - RESOUND SECURITY	Silenceable, resound on security events	Network and Local Resound
YES - RESOUND TROUBLE	Silenceable, resound for trouble	Local Resound
YES - NO RESOUND	Silenceable, does not resound	



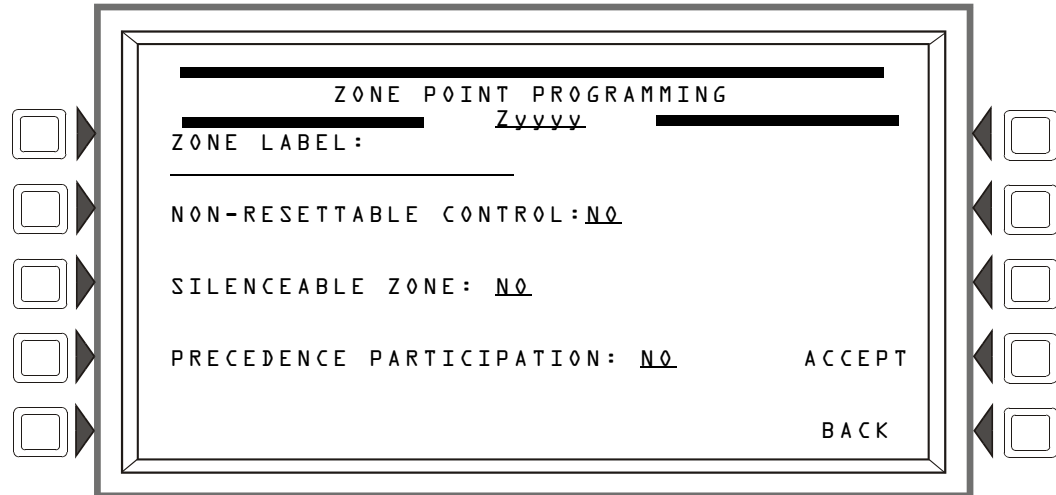
**NOTE:** This soft key will not appear for modules with Type ID codes where silence is not optional.



**NOTE:** In network applications, specific nodes can be excluded from having the ability to initiate a resound on the local fire alarm panel. This is programmable via VeriFire Tools. Refer to the *VeriFire Tools help file*.

### 3.4.3 General Zone

This screen displays when a general zone is chosen at the Point Program menu (see Figure 3.34 on page 46).



**Figure 3.49 Zone Point Programming Screen**

#### Soft Keys

**ZONE LABEL:** Press to type in a 20-character maximum zone description that will appear in the zone's display messages.

**NON-RESETTABLE CONTROL:** Select YES to designate the zone as non-resettable (not affected by System Reset), or N0 to designate the zone as resettable (zone will turn off when System Reset occurs.). Default: N0

**SILENCEABLE ZONE:** This option will designate the general zone as silenceable. When a general zone is programmed as silenceable, a signal silence local to the panel or over the network will deactivate the zone and any devices mapped to it, unless those devices are programmed with another active zone that is not silenceable. Default: N0

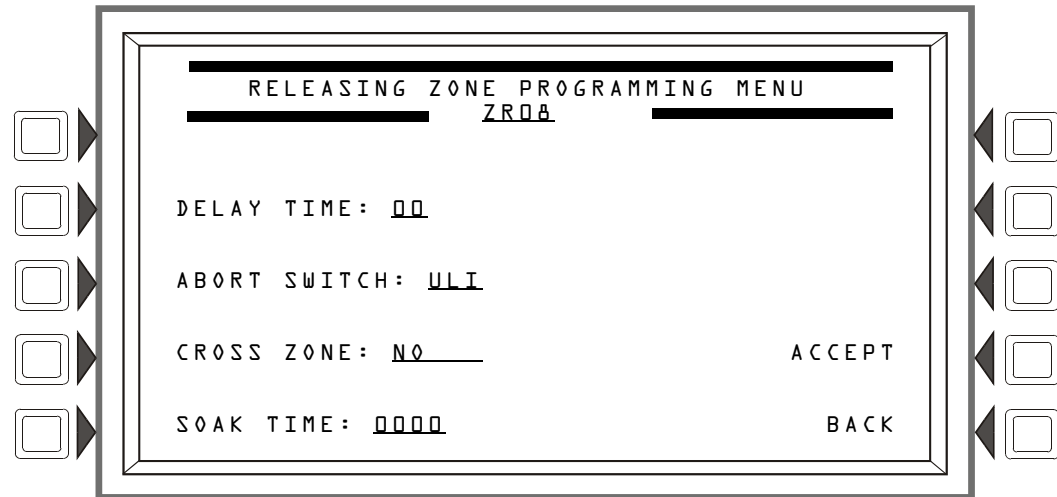
**PRECEDENCE PARTICIPATION:** Must be set to YES if the zone is programmed as a control zone to an ACM or SCS device. Default: N0

**ACCEPT:** Press to save the message and return to the previous screen.

## 3.4.4 Releasing Zone

### Releasing Zone Programming

This screen displays when a releasing zone is chosen at the Point Program menu (see Figure 3.34 on page 46).



**Figure 3.50 Releasing Zone Programming Menu Screen**

Refer to Appendix B, “Releasing Applications” for a full explanation of the fields below.

#### Soft Keys

**DELAY TIME:** Press this soft key to type a value from 0 to 60 (seconds). Default 00



**NOTE:** The FCM-1-REL has an inherent two second delay, which must be factored into the **DELAY TIME** entry.

**ABORT SWITCH:** Press this soft key to scroll through the selection list of ULI, IRI, NYC, or AHJ. Default:ULI

**CROSS ZONE:** Press to scroll through the selection list of YES, NO, ZONE, HEAT. Default: NO.

**SOAK TIME:** Press to type a value from 0 to 9999 (seconds). Default: 0000



**NOTE:** The FCM-1-REL has an inherent two second delay, which must be factored into the **SOAK TIME** entry.

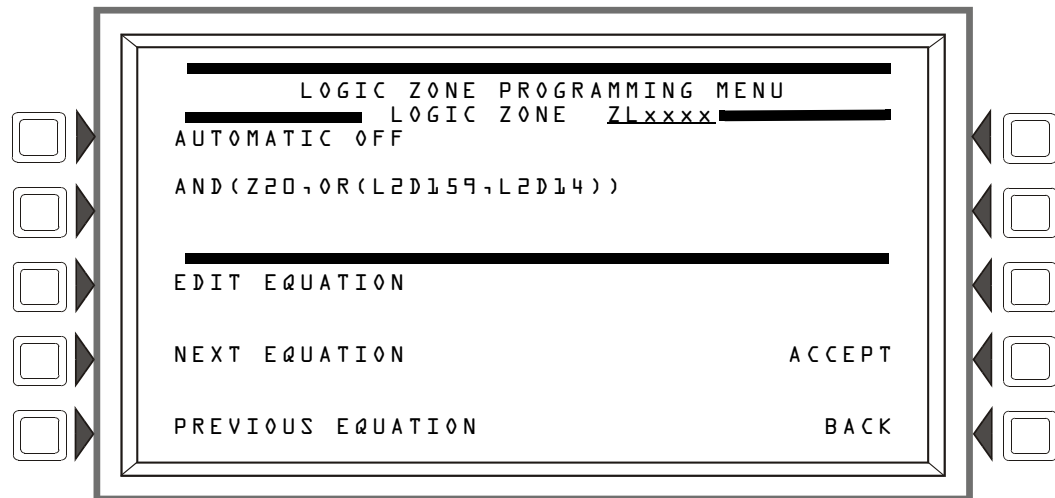
## 3.4.5 Logic Zone

### Logic Zone Programming

This screen displays when a logic zone is entered at the Point Programming Menu (see Figure 3.34 on page 46).

The logic equation for that zone will display in line 6. Line 4 indicates the current state of the logic zone (ON or OFF). If there is no equation at the logic zone number entered, nothing will display in lines 4 and 6, and the user must press the **EDIT EQUATION** soft key to proceed to the next screen and enter an equation.

Refer to Appendix E, “CBE: Zones and Equations” for information on how to create a logic equation, and how logic equations operate.



**Figure 3.51 Logic Zone Programming Menu Screen**

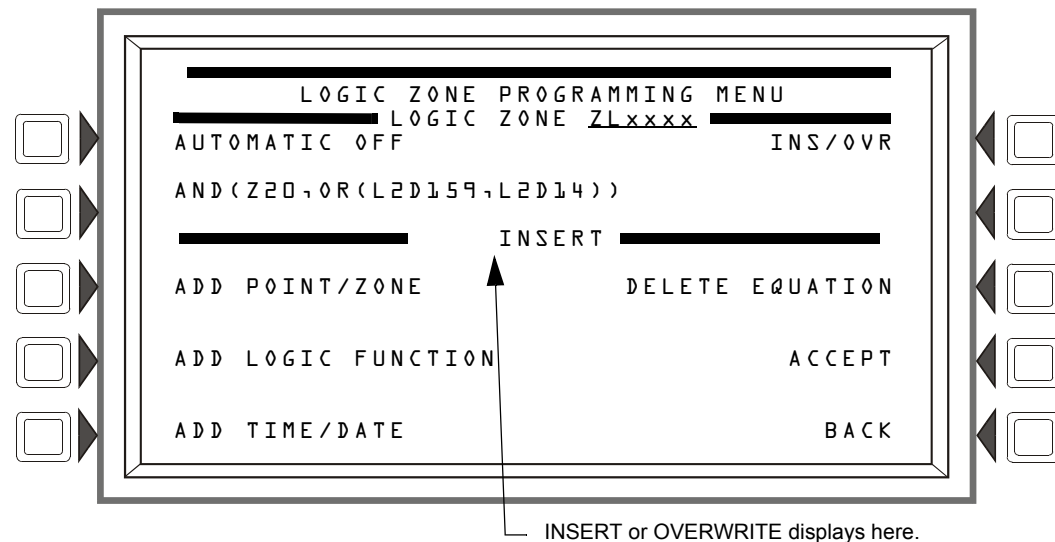
**Soft Keys**

**EDIT EQUATION:** Press to proceed to the edit screen to add or edit a logic equation.

**NEXT/PREVIOUS EQUATION:** Press to view the next or previous logic equation.

**Edit Logic Equation**

This screen displays when the **EDIT EQUATION** soft key is pressed on the Logic Zone Programming Menu



INSERT or OVERWRITE displays here.

**Figure 3.52 Edit Logic Equation Screen**

The cursor will be present in the equation, and can be moved by pressing the left/right arrow keys on the keyboard. To add or delete information, use the **INS/OVR** soft key function described below. Use the keypad to type in an equation. The **ADD POINT/ZONE** and **ADD LOGIC FUNCTION** soft keys may be used to facilitate creating a logic equation; however, commas must be added by using the keypad.

### Soft Keys

**INS/OVR**: Press to toggle between insert and overwrite. Stop at the appropriate mode, which displays in line 8 of the screen. Insert will add information to the equation, overwrite will write over information already in the equation.

**ADD POINT/ZONE**: Press to proceed to the Add Point/Zone screen. This screen is an alternative to typing in the information at this screen; it provides point and zone formats that make it less likely for typographical errors to occur.

**ADD LOGIC FUNCTION**: Press to proceed to the Add Logic Function screen. This screen is an alternative to typing in the information at this screen; it provides logic function formats that make it less likely for typographical errors to occur.

**ADD TIME/DATE**: Press to proceed to the Add Time/Date screen.

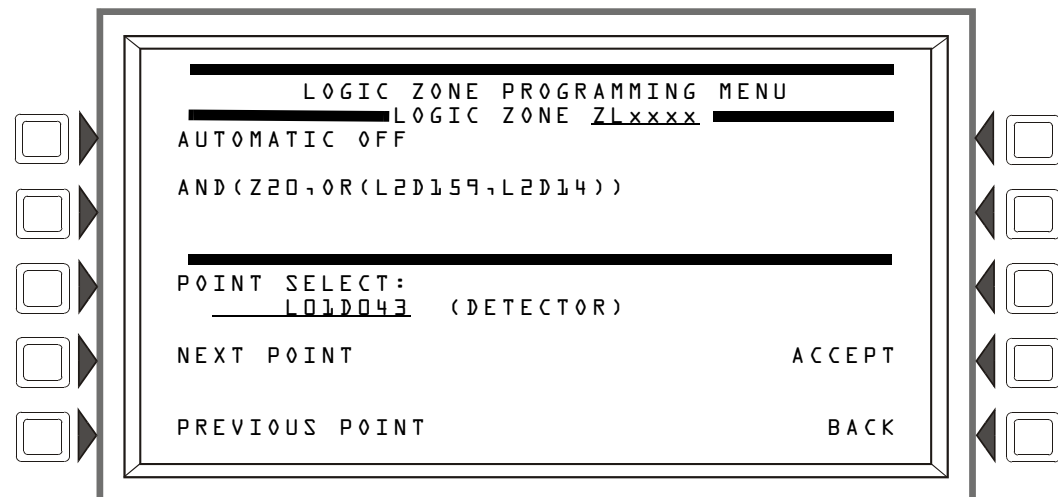
**DELETE EQUATION**: Press to delete the entire equation.

**ACCEPT**: Press to save changes made on this screen and return to the previous screen.



**NOTE:** When the **ACCEPT** soft key is pressed to save an equation, the panel checks the equation for errors. If there is an error in the equation, the previous screen will not appear, and the cursor will appear at the error point. Correct the equation, and re-press the **ACCEPT** soft key.

### Add Point/ Zone



**Figure 3.53 Add Logic Point/Zone Screen**

The cursor will be present in the logic equation. Place it, using the arrow keys on the keyboard, at the place where the additional point should be inserted.

### Soft Keys

**PPOINT SELECT**: Press to scroll through the list of possible formats (detector, module, etc.). Stop at the desired format. Type in the address for the additional point.

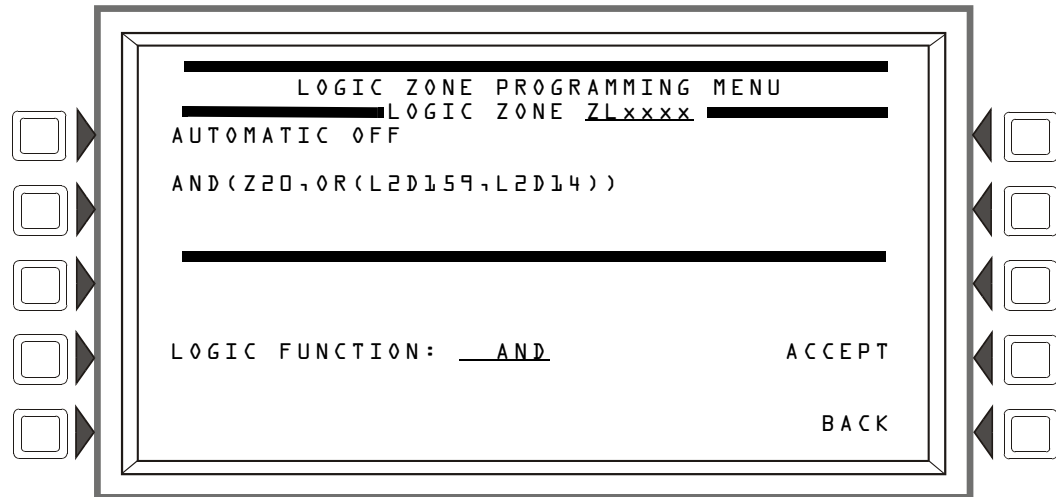
**ACCEPT**: Press to insert the point into the equation where the cursor is blinking, and to return to the previous screen.

**NEXT/PREVIOUS PPOINT**: Press these soft keys to scroll forward or backward from the displayed point to the next installed point.



## Add Logic Function

This screen appears when the **ADD LOGIC FUNCTION** soft key is pressed at the Logic Zone Programming Menu screen.



**Figure 3.54 Add Logic Function Screen**

The cursor will be present in the logic equation. Place it, using the arrow keys on the keyboard, at the place where the logic function should be inserted.

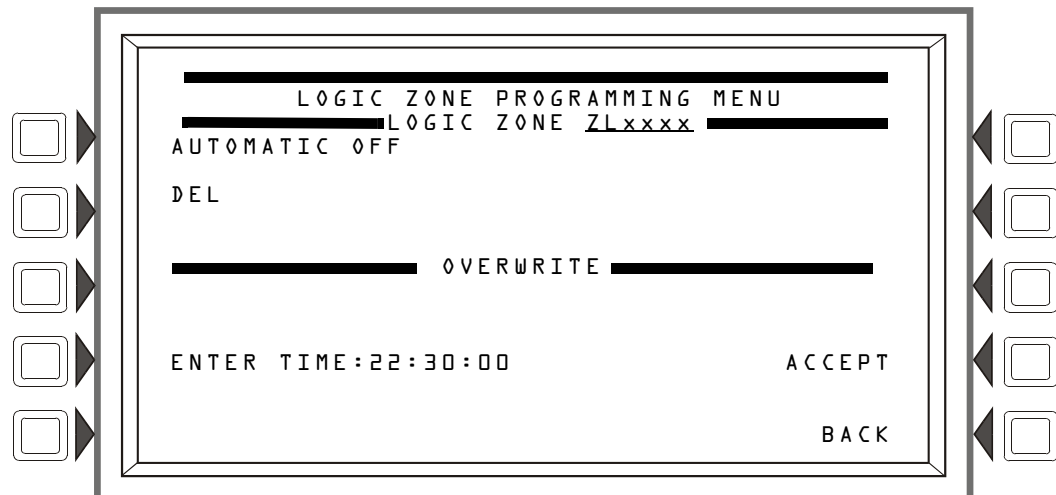
### Soft Keys

**LOGIC FUNCTION:** Press to scroll through the list of possible logic functions.

**ACCEPT:** Press to insert the logic function into the equation where the cursor is blinking, and to return to the previous screen.

## Add Time/Date

This screen appears when the **ADD TIME/DATE** soft key is pressed at the Logic Zone Programming Menu screen



**Figure 3.55 Add Time/Date to Logic Zone Screen**

### Soft Keys

**ENTER TIME: \_\_:\_\_:\_\_** Press this soft key to toggle between the time/date formats. Choose one based on the type of time-based function used.

Time-based function	Screen Field	Time/date format
DEL, SDEL, TIM	ENTER TIME: _: _: _:	HH:MM:SS, entered as military time (22:30:00 = 10:30 P.M.)
TIM	ENTER DATE: _-_- _-_-	(MM-DD-YY)
TIM	ENTER DAY: <u>MO</u>	(Use the TOGGLE DAY soft key that appears to scroll through and choose a day of the week.)

## 3.4.6 Trouble Zone

### Trouble Zone Programming

Trouble zones provide a means of using a system trouble input to effect an output. For instance, an annunciator trouble can be used to activate an output device.

The trouble zone format is ZTxxx, where xxx is a number from one through one hundred. When a trouble zone format is entered at the Point Select screen, the same programming screens and choices appear as for logic zones, except the zone format is a trouble zone format. (Refer to paragraphs “Logic Zone Programming” on page 62 and the paragraphs following “Add Time/Date”).

Refer to Appendix E, “CBE: Zones and Equations” for information on how to create a trouble equation, and how they operate.

### Add Node Offline Trouble

Node offline troubles can be added to trouble zone programming to act as a means of affecting an output in the event a node goes online or offline.

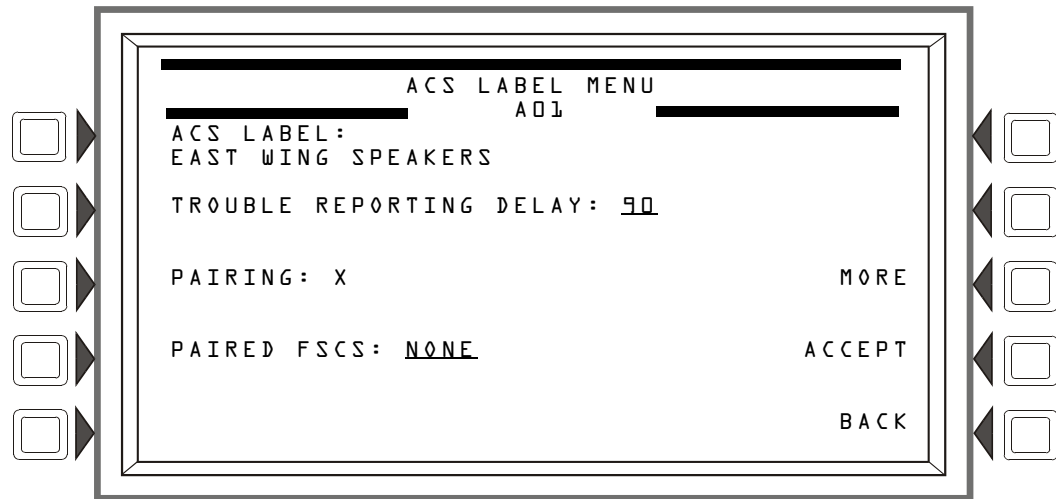
Adding a node offline trouble to the trouble zone equation is done in the same manner as described in the "Logic Zone Programming" section on page 62. However, the POINT SELECT option is not available. To add the node offline trouble, place the cursor in the desired position and type in NO###, where the ### represents the network node that is being monitored for the trouble. Refer to the following trouble zone programming examples:

**OR(NO22,NO25,NO159)** - In this example, if Node 22, Node 25, or Node 159 go offline, then the trouble zone will turn ON. Once the nodes all return to their online status, the trouble zone returns to OFF. Other parameters (detectors, modules, zones, etc.) can be used in this equation as well.

**OR(RANGE(NO78,NO81))** - In this example, if Nodes 78, 79, 80, and 81 go offline, the trouble zone will turn ON. Once any one of the nodes return to the online status, the trouble zone returns to OFF. Other parameters (detectors, modules, zones, etc.) can be used in this equation as well.

### 3.4.7 Annunciator Board Label

When `ACS BOARD` is selected from the Point Program Menu, the ACS Label Menu appears.



**Figure 3.56 ACS Label Menu Screen (1)**

#### Soft Keys

`ACS LABEL`: Type a label for the selected annunciator. The label can have up to 40 characters.

`TROUBLE REPORTING DELAY`: Smoke Control Systems only: Adjustable trouble timer for FSCS. Programmable range is 0 to 180 seconds. Default: 90



**NOTE:** This value may not exceed 90 seconds for ULC installations.

`PAIRING`: Smoke Control Systems only: Select group 1, 2 or 3 to pair up to eight (8) FSCS boards so that multiple smoke control modules can act as a single unit. If enabled, each FSCS address can only be assigned to one group and each group can be assigned up to eight (8) FSCS addresses, Default: X

`PAIRED FSCS`: Smoke Control Systems only: Displays any FSCS boards that have been paired to this annunciator.

`ACCEPT`: Press to insert the logic function into the equation where the cursor is blinking, and to return to the previous screen.

Press the `MORE` softkey to display the second ACS label screen.



**Figure 3.57 ACS Label Menu Screen (2)**

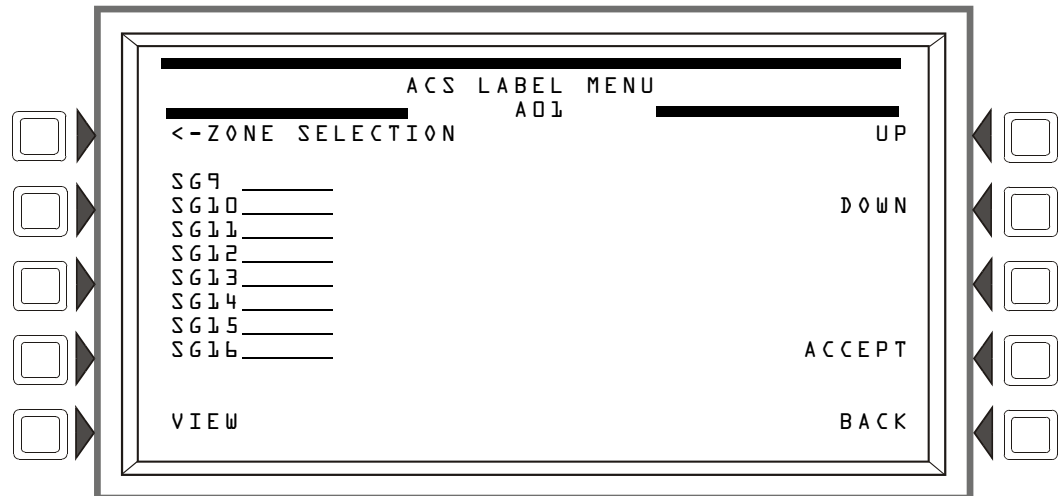
**Soft Keys**

**ZONE SELECTION:** Press to assign the zone label that is to be displayed for the switch group selected.

**VIEW:** Press to view the associated zone label for the switch group selected.

**UP/DOWN:** Press to move between switch group selections.

Press the **MORE** softkey to display the third ACS label screen.



**Figure 3.58 ACS Label Menu Screen (3)**

**Soft Keys**

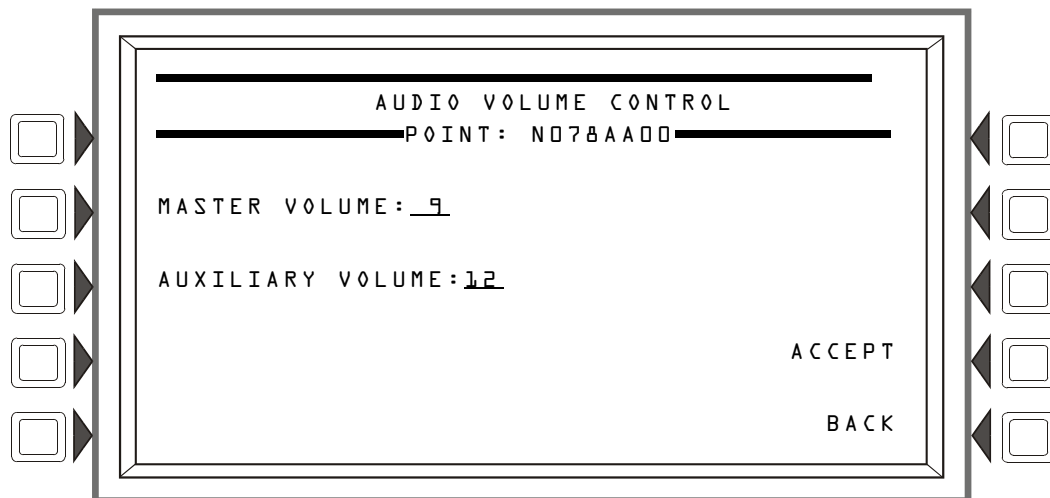
**ZONE SELECTION:** Press to assign the zone label that is to be displayed for the switch group selected.

**VIEW:** Press to view the associated zone label for the switch group selected.

**UP/DOWN:** Press to move between switch group selections.

### 3.4.8 Audio Point Programming

When DVC or DAA is selected from the Point Program menu, the Audio Volume Control menu appears.



**Figure 3.59 Audio Point Programming Menu Screen**

#### Soft Keys

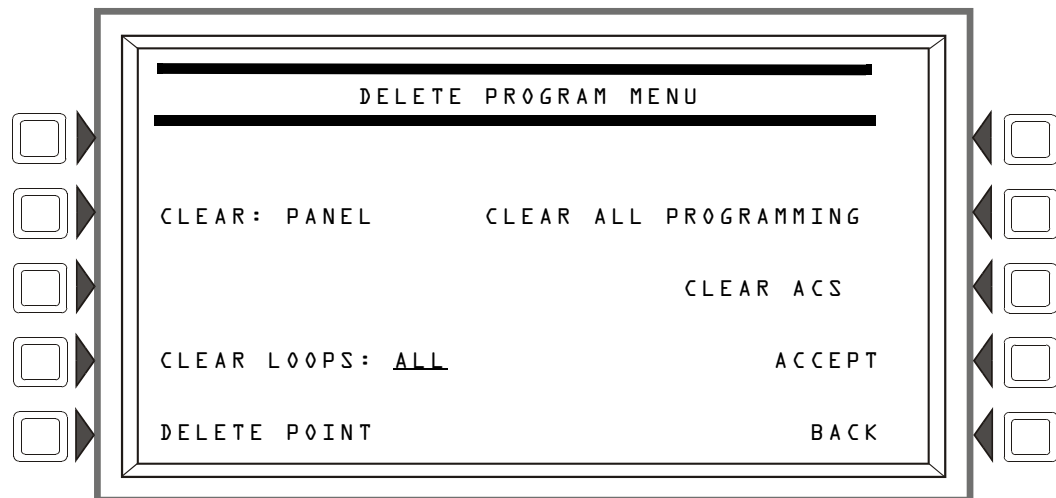
**MASTER VOLUME:** - This field can set the volume for all audio outputs at the DVC node. When the audio amplifier point is set to 00, as it is in Figure 3.59, the setting affects all audio outputs on the DVC node (this includes all outputs on its DAAs). When a specific DAA point is entered at the point program menu (for example, N078AA01), the MASTER VOLUME setting will apply to the audio outputs at that DAA (the DAA with its address set to 01). Set this field to any volume setting from 0 (off) to 15 (high). Default: 15

**AUXILIARY VOLUME:** - This field sets the volume for DVC inputs AUXA (background music from various sources or a telephone paging source) and AUXB (AMG-1 input). The field does not appear if a specific DAA address has been entered. The DAAs have onboard volume control for AUX A and AUXB inputs. Set this field to any volume setting from 0 (off) to 15 (high). Default: 15.

**ACCEPT** - Press to program the displayed volume.

## 3.5 Delete Program

Press the DELETE PROGRAM MENU at the PROGRAM/ALTER STATUS MENU menu to display the screen below.



**Figure 3.60 Delete Program Menu Screen**

### Soft Keys

**CLEAR ALL PROGRAMMING:** Press to remove all panel, loop, point and ACS programming information, as well as logic and trouble zone equations. Pressing this key removes everything except passwords. A confirmation screen will display asking the user to confirm the deletion command. Pressing this key causes a reboot.

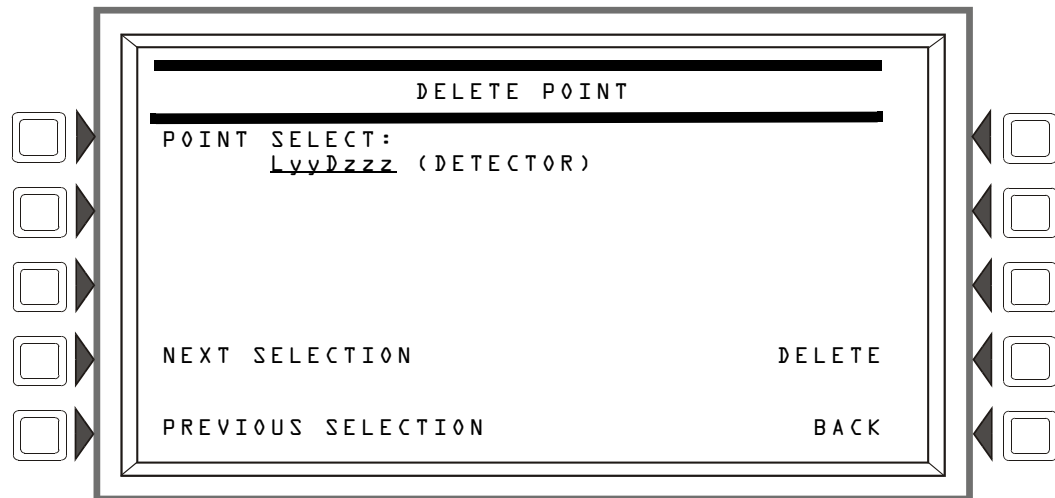
**CLEAR: PANEL** Press to remove all programmed panel setting information from control panel memory. This does not remove ACS programming. A confirmation screen will display asking the user to confirm the deletion command. Pressing this key causes a reboot.

**CLEAR LOOPS** Press to scroll through the options: ALL, LOOP 1, LOOP 2, ..., LOOP 10. Stop at the desired option. Press **ACCEPT** to delete all loop programming for the selected option. Pressing this key causes a reboot.

**DELETE POINT** To delete a point, press this soft key to display the Delete Point screen.

**CLEAR ACS:** Press to remove all ACS programming from panel memory. A confirmation screen will display asking the user to confirm the deletion command. Pressing this key causes a reboot.

**ACCEPT:** Press to clear all programming for the selected loop option for **CLEAR LOOPS**. A confirmation screen will display asking the user to confirm the deletion command.



**Figure 3.61 Delete Point Screen**

**POINT SELECT:** Press to scroll through the options: detector or module. Stop at the desired option. Press the **DELETE** soft key to delete the point from programming. A confirmation screen will display asking the user to confirm the deletion command.



**NOTE:** Deleting points that are active or in trouble will cause a reboot.

**NEXT/PREVIOUS SELECTION** Press to scroll sequentially to the next or previous point.

## 3.6 Autoprogram Menu

The Autoprogram option identifies addressable devices connected to the control panel. Devices include addressable detectors and modules connected to the panel's SLCs. The Autoprogram can be used to create a new program, or to add or remove devices from an existing program. When the points are accepted, they are added to the panel's database with the defaults described in the "Point Programming" section of this manual.

### 3.6.1 To Create a New Program

To successfully create a new program, the FACP must either be new, or have no existing program in memory for the loops involved.

1. Use the Delete Program Menu screen (refer to Figure 3.60) to clear any applicable programming from the panel. For example, if loops one and two are to be autoprogrammed, clear the programming that exists by entering **1+2** at the Delete Program Menu screen.
2. Install SLCs (loops **1+2** in this example) using the Loop Programming screen (Figure 3.30).
3. Press the **AUTOPROGRAM LOOPS** soft key and enter the desired SLCs (loops **1+2** in this example) in the Autoprogram Menu screen (Figure 3.62)
4. Press the **ACCEPT** soft key to run the Autoprogram.

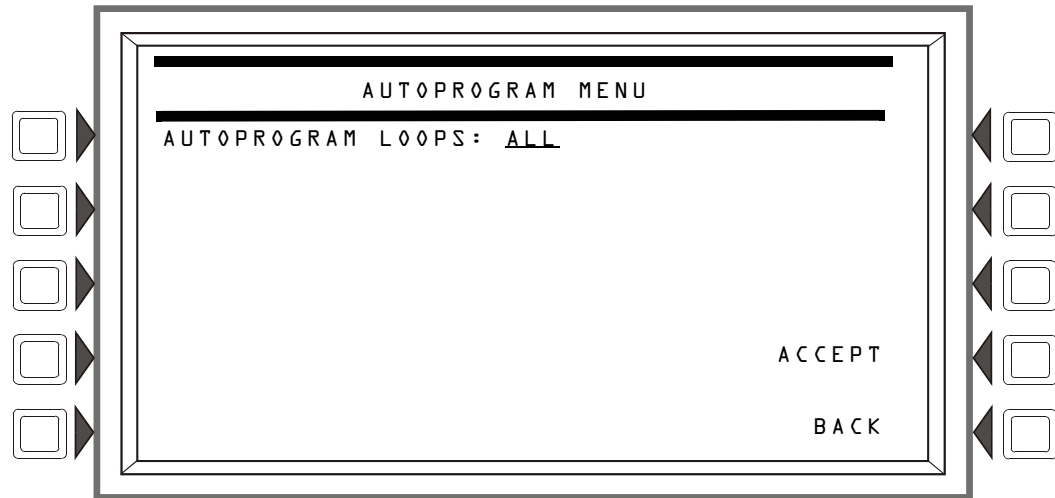
### 3.6.2 To Add/Delete Devices from the Program

When using the Autoprogram option with an existing program, the control panel does not change program information for installed and programmed devices.

1. If devices are to be added to a new SLC (an SLC that is not in the program), that SLC must be installed using the Loop Programming screen (Figure 3.30).

2. Physically install/uninstall the SLC devices.
3. Press the `AUTOPROGRAM LOOPS` soft key to run the Autoprogram. Existing information will not be changed.

Autoprogram will find the devices/modules on the selected installed SLCs. It will compare the information it finds during autoprogramming against any point information that may already be in the database, and it will look for any addressing errors, such as two detectors with the same address. If it finds a discrepancy or error, a screen will be displayed with the discrepant or incorrect information and the programmer will be given the option of changing it.



**Figure 3.62 Autoprogram Menu Screen**

#### Soft Keys

`AUTOPROGRAM LOOPS`: Press to scroll through the options: ALL, 1+2, 3+4, 5+6, 7+8, 9+10. Stop at the desired option to select it.

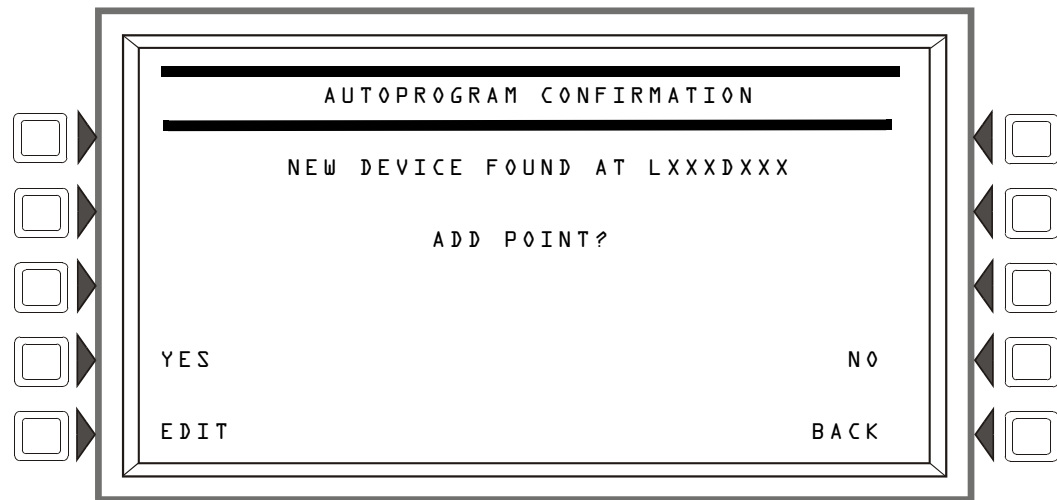
`ACCEPT`: Press to autoprogram the selection. A confirmation screen will display asking the programmer to confirm the autoprogram choice made (press the YES soft key to confirm). A screen with the message `AUTOPROGRAM IN PROGRESS` will display until autoprogramming is complete.





## Add New Points

When the **REVIEW** soft key is pressed, the panel will individually display each new SLC point found during autoprogramming. The screen below uses an SLC detector point as an example.



**Figure 3.64 Autoprogram Confirmation Screen (New SLC Point)**

### Soft Keys

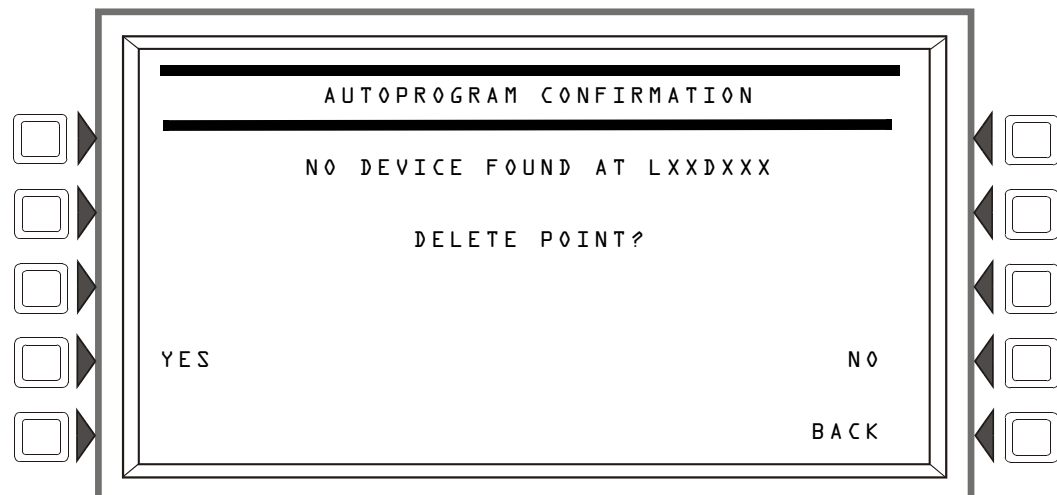
**YES:** Press this soft key to install the new point into the panel's database.

**EDIT:** Press this soft key to advance to the point programming menu for the new point.

**NO:** Press if the point will not be installed.

### Error and Discrepancy Resolution

Pressing the **REVIEW** soft key will bring up screens that provide the means to resolve any errors or discrepancies found during autoprogram.



**Figure 3.65 Autoprogram Confirmation Screen (Missing Point)**

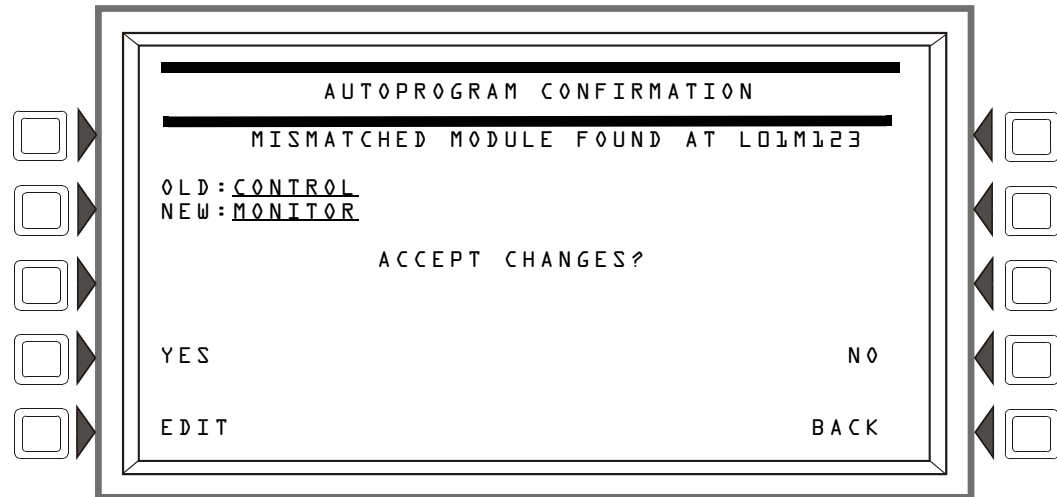
### Display

This screen will display the SLC device address when a previously installed/programmed point does not respond during a subsequent Autoprogram.

**Soft Keys**

**YES:** Press to delete the point information from the panel's database.

**NO:** Press to leave the point information in the panel's database.



**Figure 3.66 Autoprogram Confirmation Screen (Mismatched Point)**

**Display**

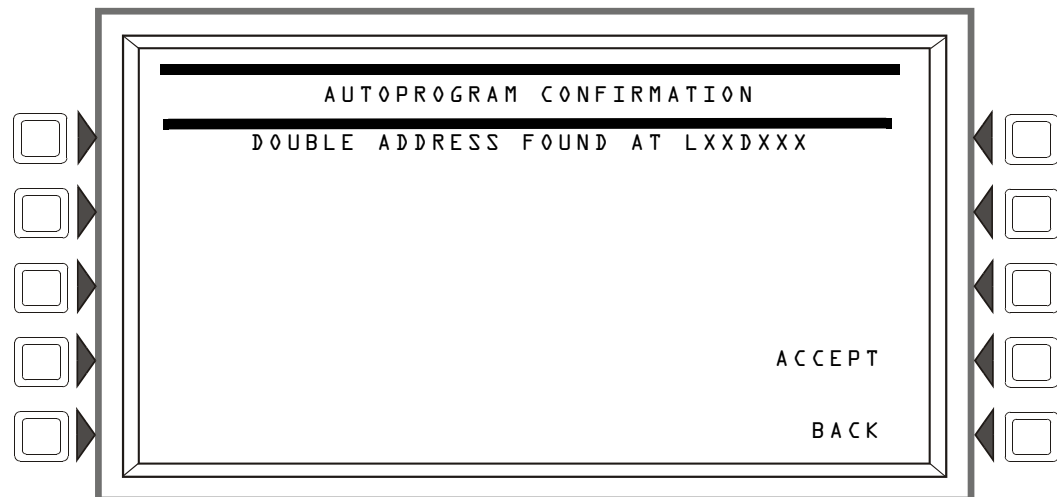
The **OLD** field contains the information currently in the panel's programming database. The **NEW** field contains the information found during autoprogramming. The fields contain the FlashScan Type ID codes if the device is FlashScan, or they will contain the device type if CLIP.

**Soft Keys**

**YES:** Press this soft key to accept the new device type.

**EDIT:** This soft key will appear only when SLC devices are mismatched. Press it to advance to the point programming screen for this point.

**NO:** Press if the new information should not be installed over the existing information in the database.



**Figure 3.67 Autoprogram Confirmation Screen (Double Address)**

**Display**

The SLC loop number and device address are displayed where the Autoprogram has found more than one detector or module with the same address.

**Soft Keys**

**ACCEPT** : Pressing this soft key acknowledges that the programmer has been informed of the double address. Autoprogram will not make a modification to the database for this point. The installer must correct this problem.

## Section 4: Alter Status

Alter Status provides a programming level for changing operating parameters such as detector sensitivity, Walk Test, changing system time/date and disabling/enabling points. Alter Status is accessible with the Master Password and with User Passwords programmed for Alter Status.

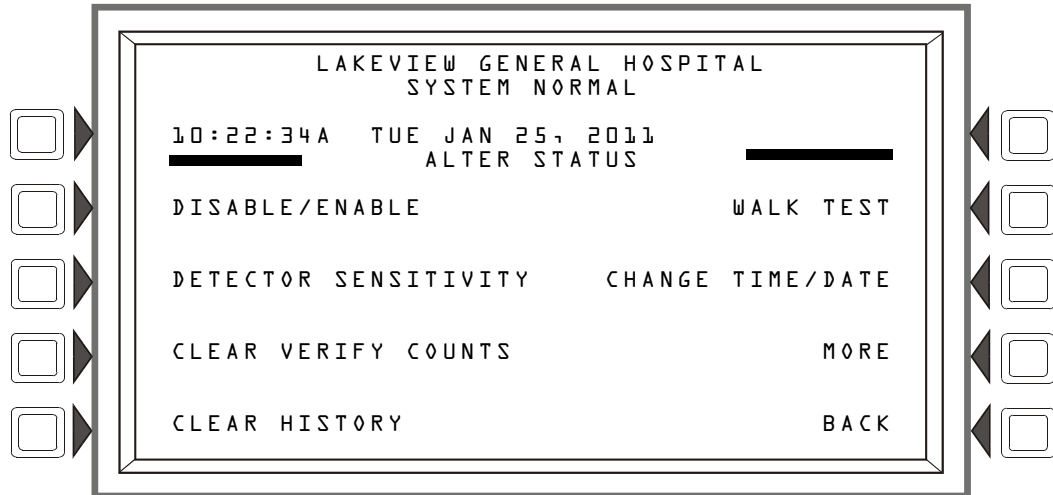
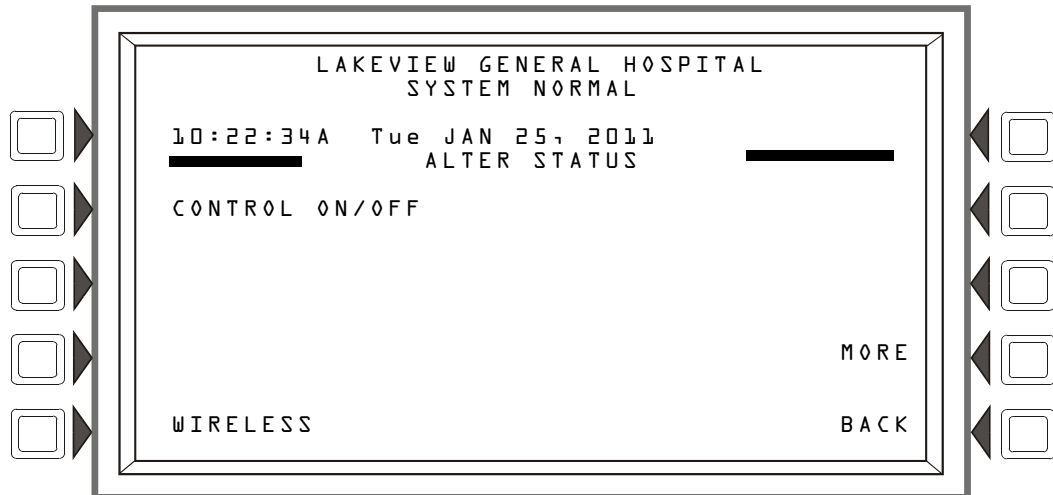


Figure 4.1 Alter Status Screen (1)

Figure 4.2 Alter Status Screen (2)



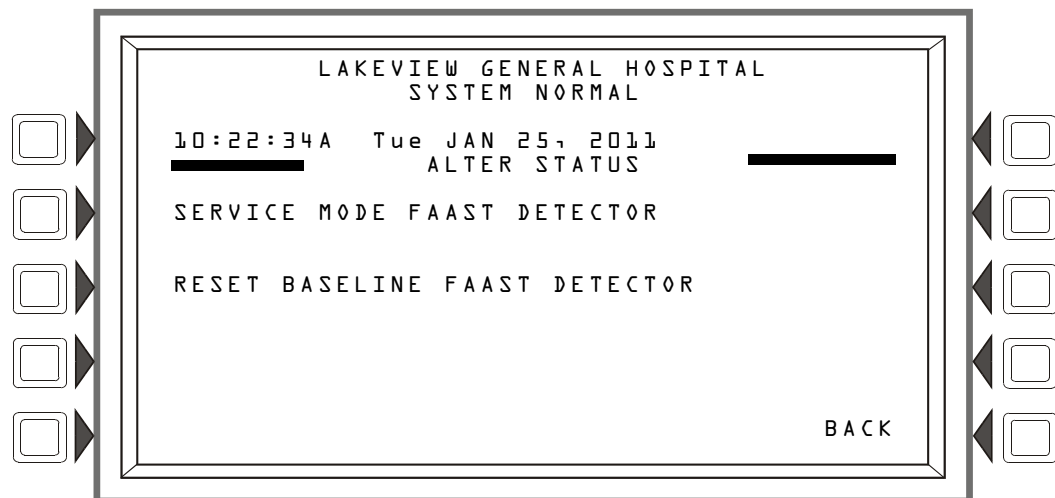


Figure 4.3 Alter Status Screen (3)

#### Soft Keys

All soft key selections (except BACK) are menu selections. Press to display the desired menu.

## 4.1 Disable/Enable Point Selection

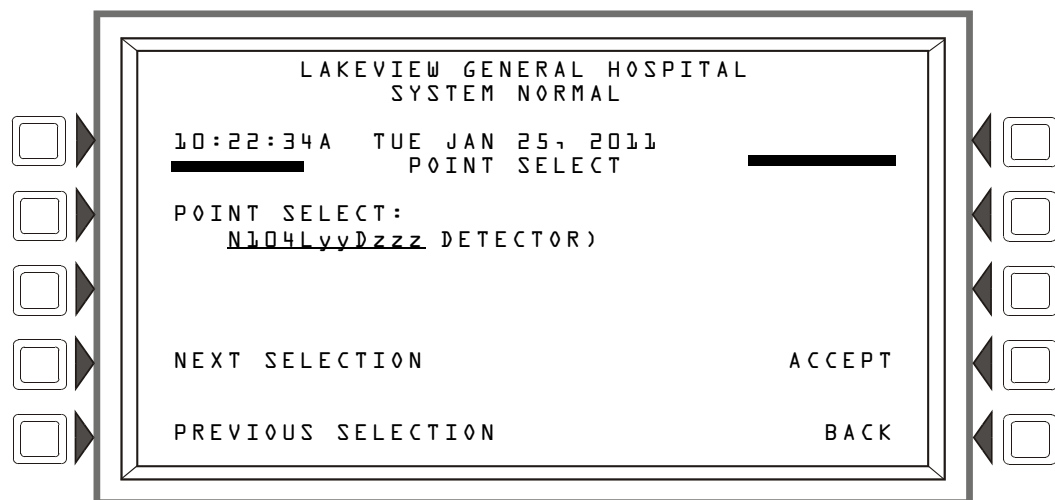


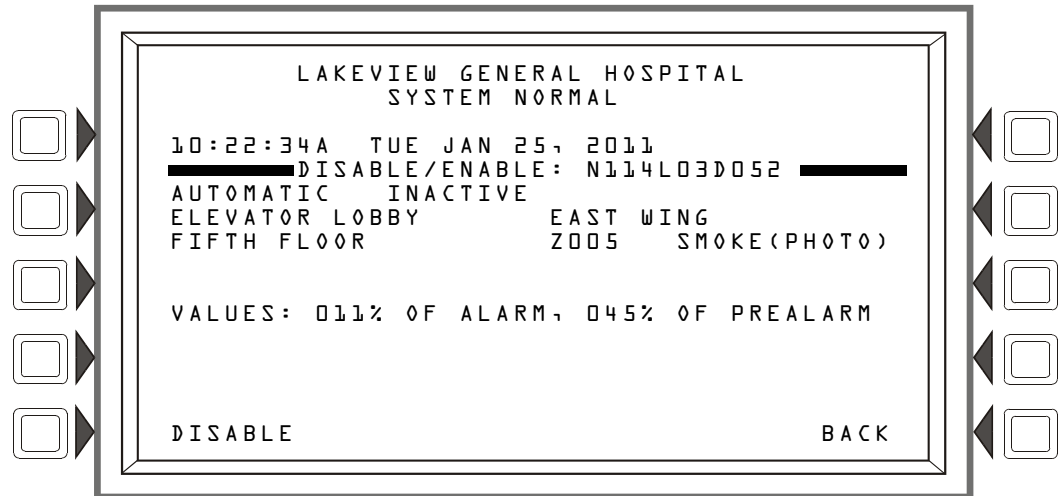
Figure 4.4 Point Select for Disable/Enable Screen

#### Soft Keys

**POINT :** Press this soft key to identify the type of point to disable/enable: the choices that will appear in parentheses next to the point format are DETECTOR, MODULE, LOGIC ZONE, GENERAL ZONE, or DAA SPEAKER CIRCUIT. Enter the address of the point using the keyboard. If there is an event in the display area, that address will be the default. If no event is present, the default format will be that of a detector.

## 4.2 Disable/Enable

A point can be disabled or enabled using this screen. Press the **DISABLE/ENABLE** soft key at the Alter Status screen to display the following.



**Figure 4.5 Disable/Enable Screen**

### Soft Keys

**DISABLE/ENABLE** Only the applicable command will display. Press to disable an installed, programmed point, or to enable a disabled one.



**CAUTION:**

WHEN A DISABLED OUTPUT IS ENABLED, IT WILL BE AFFECTED BY CONDITIONS EXISTING IN THE SYSTEM THAT WOULD NORMALLY AFFECT IT. THAT IS, IF A CONDITION EXISTS THAT WOULD HAVE TURNED THE OUTPUT ON WERE IT ENABLED, IT *WILL* TURN ON WHEN IT IS ENABLED.



**NOTE:** When an input or output point associated with releasing functions is disabled, a single supervisory trouble will be generated.

Group Zone Disable - This term refers to the disabling (or enabling) of a general zone. If the first position in a device's zone map matches the general zone number entered at this screen, that device will be disabled (or enabled).

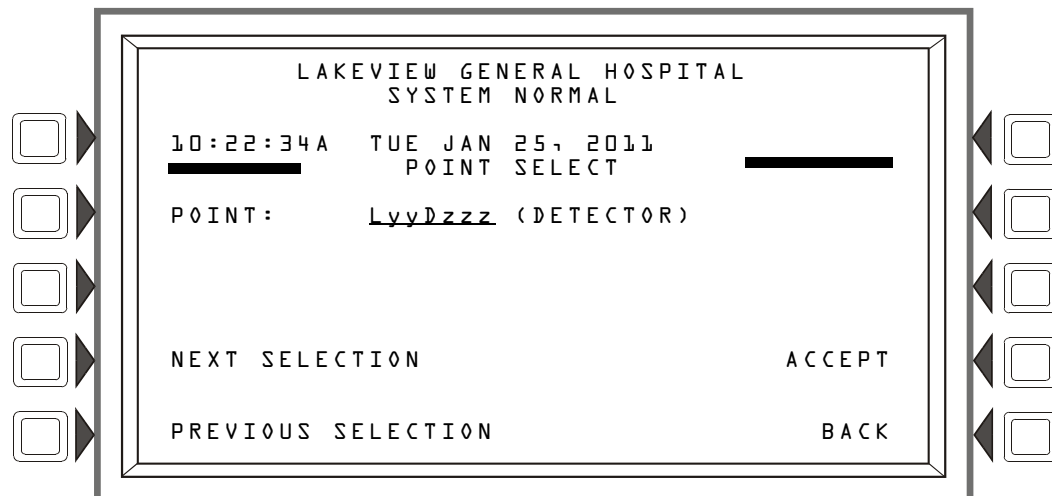


**WARNING:**

DO NOT RELY ON DISABLE TO DISABLE RELEASING POINTS DURING TESTING. RELEASING POINTS MUST BE PHYSICALLY DISCONNECTED.

## 4.3 Detector Sensitivity

This screen is displayed when the “Detector Sensitivity” soft key is pressed on the Alter Status Menu screen.



**Figure 4.6 Sensitivity Select Point Screen**

### Soft Keys

**P0INT:** Press to place the cursor in the format field. Type the address using the keyboard.

**NEXT/PREVIOUS SELECTION:** Press these soft keys to scroll sequentially through the detector addresses on the loop. The screen will display the next loop when the last device on this loop is passed.

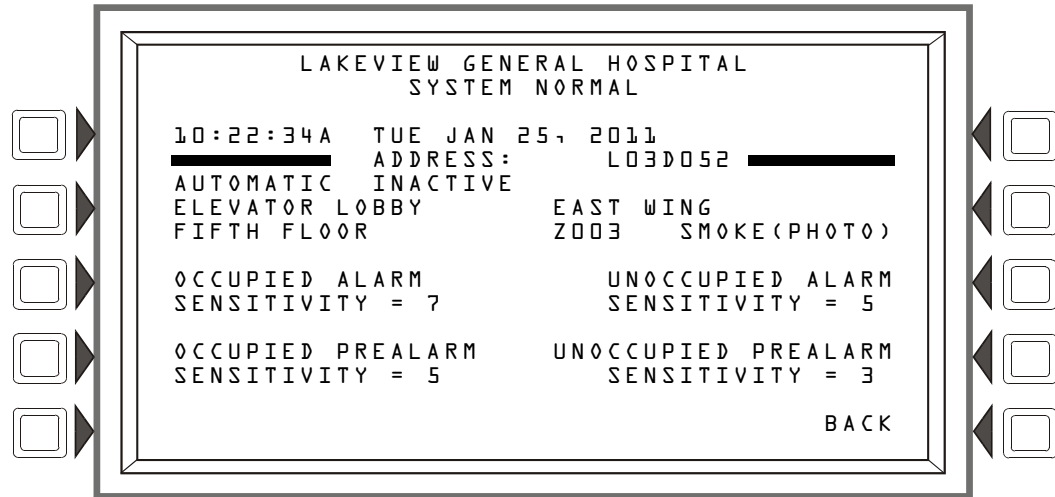
**ACCEPT:** Press to proceed to the Detector Sensitivity screen.

### 4.3.1 Sensitivity Select

Detector sensitivity levels, set during initial programming, may be changed through accessing the Detector Sensitivity Select screen and the command screen that follows. The Detector Sensitivity Select screen is displayed when the **ACCEPT:** soft key is pressed at the Sensitivity Select Point screen.



The current sensitivity values displayed are described in Detector Point Programming (Refer to the paragraph “Sensitivity” on page 51) and in Appendix D, “Intelligent Sensing Applications”.



**Figure 4.7 Detector Sensitivity Select Screen**

**Soft Keys**

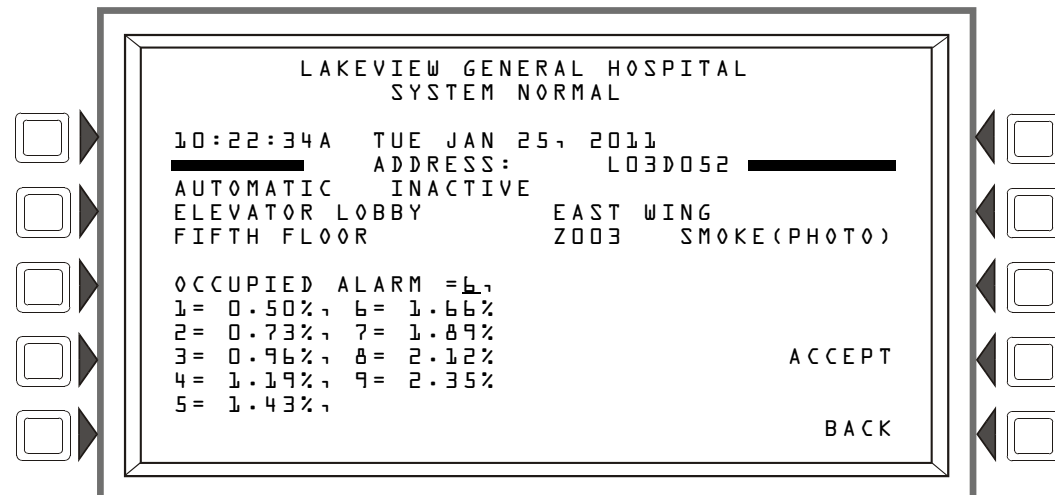
- OCCUPIED ALARM SENSITIVITY:
- OCCUPIED PREALARM SENSITIVITY:
- UNOCCUPIED ALARM SENSITIVITY:
- UNOCCUPIED PREALARM SENSITIVITY:

Press the soft key next to one of these setting categories to proceed to the next screen, where the setting value may be changed.

**Change Alarm/Prealarm Sensitivity**

This screen displays when any of the soft keys is pressed on the Detector Sensitivity Select screen. The user can change detector sensitivity values using this screen.

The settings (1-9) displayed below the soft key are unique to the type of detector.



**Figure 4.8 Change Alarm Sensitivity Screen**

**Soft Keys**

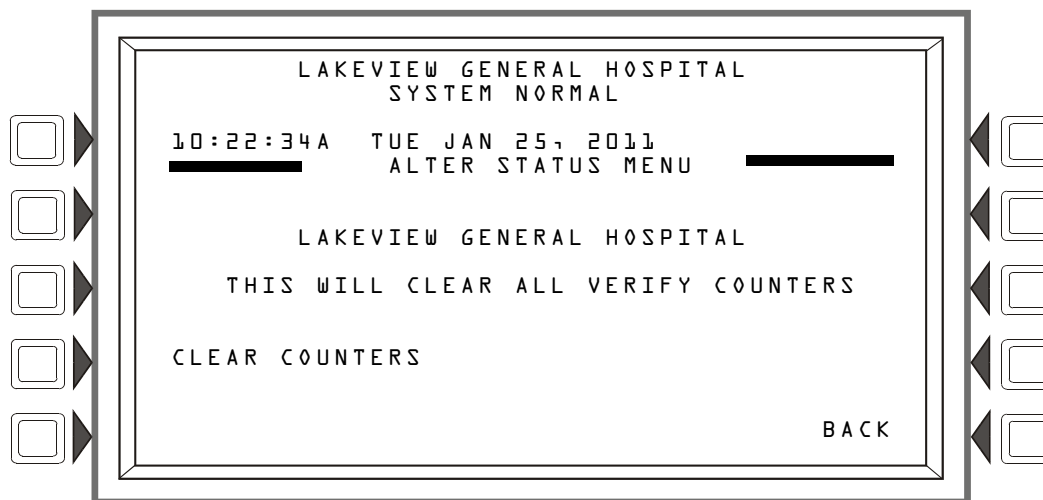
OCCUPIED ALARM: The type of alarm/prealarm will display based on which soft key was pressed in the previous screen. For example, in the screen above, OCCUPIED ALARM displays because the OCCUPIED ALARM SENSITIVITY: soft key was pressed.

The detector sensitivity values display below the soft key. Select a value by pressing the soft key until the desired value appears in the underlined field.

ACCEPT: Press to accept the change made on this screen, and to return to the previous screen.

## 4.4 Clear Verify Counters

The Clear Verify Counters screen lets you clear all counters for detectors selected for Alarm Verification on the FACP. It displays when the “CLEAR VERIFY COUNTERS” soft key is pressed on the Alter Status Menu screen.



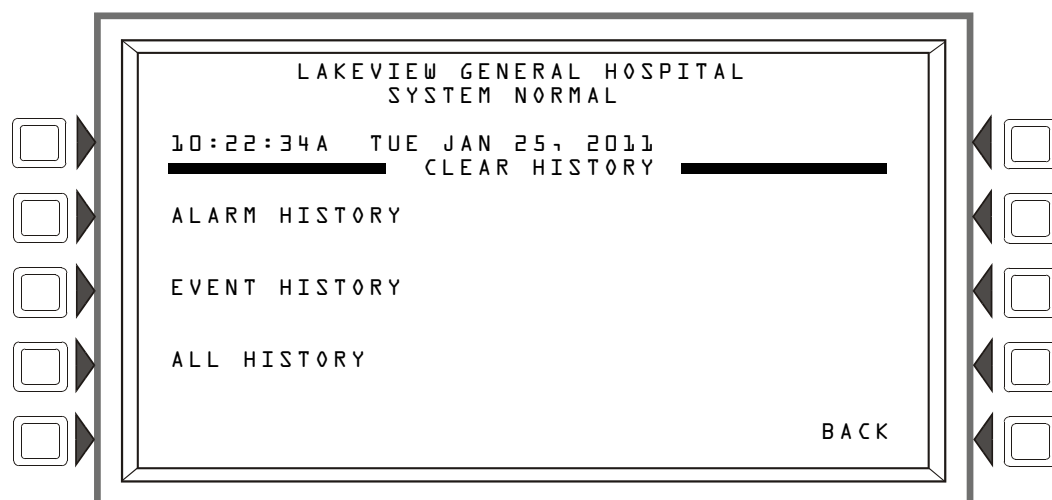
**Figure 4.9 Clear Verify Counters Screen**

**Soft Keys**

CLEAR COUNTERS: Press this soft key to clear all verification counters.

## 4.5 Clear History

This screen is displayed when the CLEAR HISTORY soft key is pressed on the Alter Status Menu screen. It brings the user to a command screen, where the type of history may be selected for clearing.



**Figure 4.10 Clear History Screen**

#### Soft Keys

**ALARM HISTORY:** Press to clear Alarm history.

**EVENT HISTORY:** Press to clear Event history.

**ALL HISTORY:** Press to clear both Alarm and Event history.

## 4.6 Walk Test

Walk Test allows the user to test the entire fire alarm system while away from the control panel. There are two types of Walk Test - Basic and Advanced - and each type operates in audible mode.

Walk Test results are sent to the printer and to Event History as “Test”. In Network applications, specific nodes can be excluded from having the ability to force the fire panel out of Walk Test. This is programmable via VeriFire Tools. Refer to the *VeriFire Tools help file*.



#### **WARNING:**

PHYSICALLY DISCONNECT ALL RELEASING DEVICES BEFORE STARTING WALK TEST. IT IS NOT SUFFICIENT TO DISABLE IN ANY OTHER MANNER.



#### **WARNING:**

WALK TEST MODE CAN DEACTIVATE FIRE PROTECTION. OBSERVE THE FOLLOWING IMPORTANT PRECAUTIONS.

#### **IMPORTANT!**

- Prior to Walk Test, secure all protected buildings, and notify the building owner/operator, fire department, and other pertinent personnel that testing is in progress.
- Immediately after Walk Test is completed, notify the same people that testing is complete and the system is restored to normal operation. Reconnect releasing devices.
- Walk Test will “time out” and return to normal operation after one hour when no Walk Test activations have occurred during that time.
- Walk Test may be exited at any time by pressing the **ABORT** soft key on the screen.




---

**NOTE:** Walk Test will not start if any devices are active (i.e., fire alarms, security, supervisories or pre-alarms). To perform a walk test while a device is active, disable the device and press the System Reset button.

---

**NOTE:** In network applications, specific nodes can be excluded from having the ability to force the fire panel out of Walk Test due to an alarm condition. This is programmable via VeriFire Tools. Refer to the *VeriFire Tools help file*.

---

**Basic Walk Test** - The basic test allows a single operator to run audible tests on the panel. All logic equation automation is suspended during the test. All ACS devices will default to Disable. They may be enabled by selecting NO at the DISABLE ACS BOARDS soft key on the Walk Test Menu screen (Figure 4.11).

**Advanced Walk Test** - The advanced test allows field-supplied output point programming that will react to input stimuli such as CBE and logic equations. When points are activated in advanced testing, each initiating event will latch the input. Release of the latch and subsequent activation of the next point is controlled through use of the NEXT TEST soft key. All ACS devices default to disable. They may be enabled by selecting NO at the DISABLE ACS BOARDS soft key on the Walk Test Menu screen (Figure 4.11). An advanced test is audible.

An audible test is intended for pull station verification, magnet-activated tests on input devices, input and output device and wiring operation/verification. Only devices previously configured to participate and designated as part of the test through the following screens will make sound.

#### ■ Walk Test Activation Indications

**FlashScan poll mode** - Once the START TEST soft key has been pressed:

- Each intelligent addressable input device will blink its address in red, and each intelligent addressable output device will blink its address in green. Pattern examples are given below.

Address	Blink Pattern
8	8 blinks, long stop, 8 blinks, long stop, ...
37	3 blinks, stop, 7 blinks, long stop, 3 blinks, stop, 7 blinks, long stop, ...
152	15 blinks, stop, 2 blinks, long stop, 15 blinks, stop, 2 blinks, long stop, ...

- An input device activated in Walk Test latches on steady green for the duration of the test. If the device is put in trouble (for instance, the detector head is removed, then replaced), the LED will be latched on for the duration of the test.
- An output device activated in Basic Walk Test will remain active and the LED will glow steady green for
  - 4 seconds for alarms
  - 8 seconds for troubles.
- An output device activated in Advanced Walk Test will remain active and the LED will glow steady green until the NEXT TEST soft key is pressed.

**CLIP poll mode** - Once the START TEST soft key has been pressed:

- Intelligent addressable input and output devices continue to blink red as usual until activated.
- An input device activated in Walk Test latches on steady red during activation. If the device is put in trouble (for instance, the detector head is removed, then replaced), the LED will be latched on for the duration of the test.
- An output device activated during Basic Walk Test will remain active and the LED will glow steady green (if a FlashScan module) or steady red (if a CLIP module) for
  - 4 seconds for alarms
  - 8 seconds for troubles.

- An output device activated in Advanced Walk Test will remain active and the LED will glow steady green (if a FlashScan module) or steady red (if a CLIP module) until the NEXT TEST soft key is pressed.

**Conventional Devices** - Monitor modules with the Type Codes SMOKE CONV, HEAT DETECT, and SMOKE DETECT, and outputs with the Type Code FORM C RESET do not participate in Walk Test other than blinking their addresses if they are polled in FlashScan mode unless they are used with a FlashScan zone module. To prevent the occurrence of false alarms for conventional devices, 24 volt power will be interrupted for up to a minute after Walk Test has been exited.

## 4.6.1 Walk Test Menu

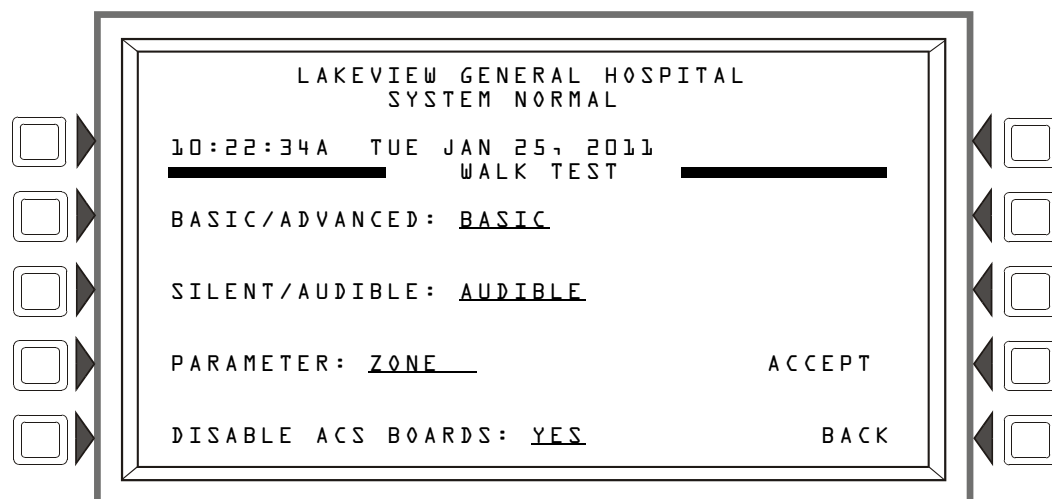


Figure 4.11 Walk Test Menu Screen

### Soft Keys

**BASIC/ADVANCED**: Press to toggle between the two choices. Stop at the desired test.

**SILENT/AUDIBLE**: This soft key is for future use. Walk test is audible.

**PARAMETER**: Press to scroll through the choices. Stop at the desired parameter. Choosing the loops parameter will bring up the Walk Test loops programming screen. (Refer to Figure 4.12.) Choosing the Zone parameter will bring up the Zone Walk Test screen. (Refer to Figure 4.15.) Choosing the Devices parameter will bring up the Devices Walk Test screen (Refer to Figure 4.13.)

If this parameter is chosen...	The participating devices/points in Basic Test will be...	The participating devices/points in Advanced Test will be...
LOOPS	All devices/points on all the FACP SLCs that are set to participate in Walk Test with the exception of logic equations, whose activation is suspended. When an input test is initiated, only the outputs on the corresponding loop will activate.	All devices/points on all the FACP SLCs that are set to participate in Walk Test. When an input test is initiated, outputs mapped on all loops will activate.

Table 4.1 Walk Test Parameters (1 of 2)

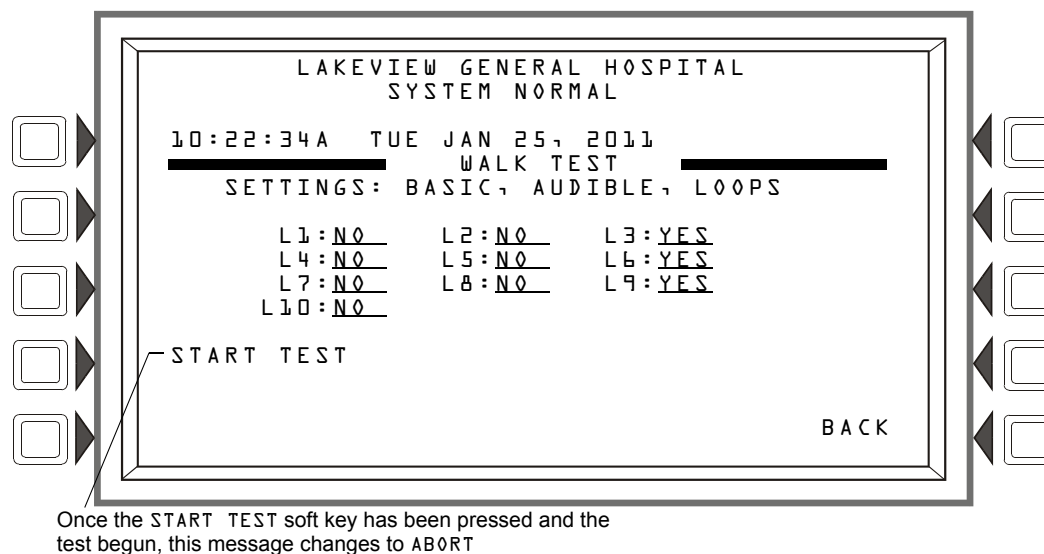
If this parameter is chosen...	The participating devices/points in Basic Test will be...	The participating devices/points in Advanced Test will be...
PANEL	The entire panel - all devices/points set to participate in Walk Test - will participate with the exception of logic equations, whose activation is suspended. When an input test is initiated, only the outputs on the corresponding loop will activate.	The entire panel - all devices/points set to participate in Walk Test - will participate. When an input test is initiated, outputs mapped on all loops will activate.
DEVICES	Individual detectors tested one at a time.	Detectors only.
ZONE	For BASIC Walk test only. When the zone entered in the parameter field is present in a device's first (primary) CBE location, that device will go into Walk Test when the parameter zone is put into Walk Test. When an input test is initiated, outputs mapped to the corresponding zone on all loops will activate.	n/a

**Table 4.1 Walk Test Parameters (2 of 2)**

**DISABLE ACS BOARDS:** This soft key allows the operator to disable ACS devices during Walk Test. Press to toggle between the two choices, YES (disable) and NO (enable). Default: YES

### 4.6.2 Walk Test Loops Parameters

This screen appears when L00PS is chosen as a parameter at the Walk Test Menu.



**Figure 4.12 Walk Test Loops Programming Screen**

The chosen settings are displayed (BASIC, AUDIBLE in Figure 4.12), and installed loops will display with a participation field. The up and down arrow keys on the keypad navigate through the fields. Choose YES for participation, NO for no participation, using the NEXT SELECTION(+)/PREVIOUS SELECTION(-) keys on the keypad.

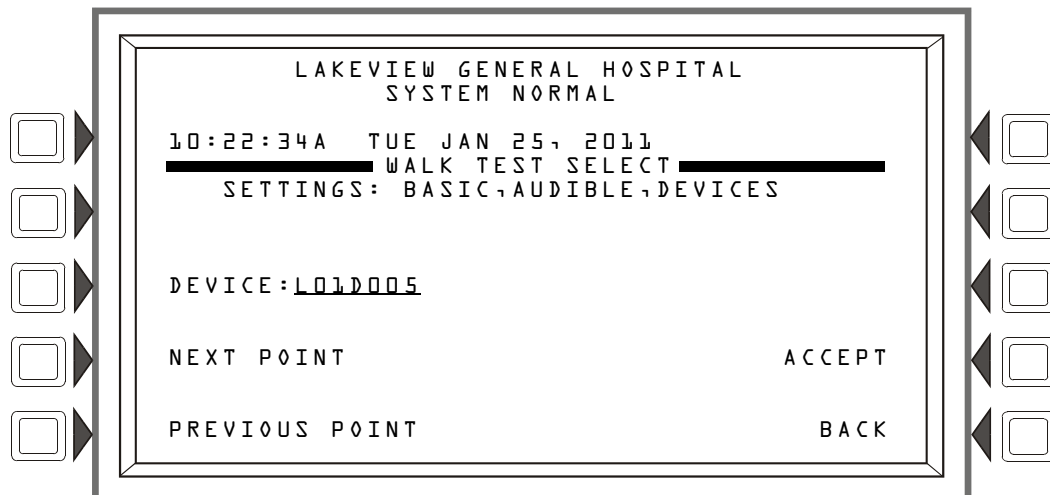
**Soft Keys**

**START TEST:** Press to begin Walk Test using the chosen parameters. Once Walk Test has begun, this soft key becomes ABORT, and can be pressed at any time to exit Walk Test.

**NEXT TEST:** This key appears for Advanced Walk Tests when the panel parameter is chosen at the Walk Test Menu Screen. Refer to Figure 4.16 for the location of this key. Press it to progress from one activation to the next, latching the new point and releasing the latch on the previous point.

### 4.6.3 Point Walk Test Activation

This screen appears when **DEVICES** is chosen as a parameter at the Walk Test Menu.



**Figure 4.13 Walk Test Devices Programming Screen**

This screen appears when **DEVICES** is chosen as a parameter at the Walk Test Menu. The chosen settings are displayed (**BASIC**, **AUDIBLE** in Figure 4.13).

#### Soft Keys

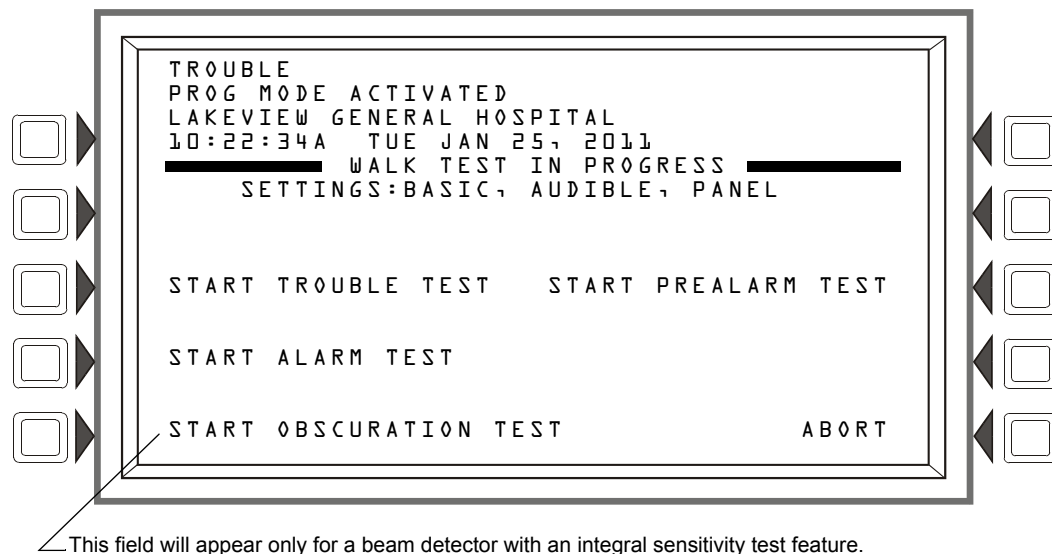
**DEVICE:** Press this key to type the desired detector address into the underlined field.

**NEXT POINT:** Press this key to bring up the next installed address for an addressable detector into the **DEVICE** field.

**PREVIOUS POINT:** Press this key to bring up the previous installed address of an addressable detector into the **DEVICE** field.

**ACCEPT:** Press this key to begin Walk Test, and to proceed to the Devices Test Selection screen (Figure 4.14).

## 4.6.4 Devices Test Selection



**Figure 4.14 Devices Test Selection Screen**

### Soft Keys

**START TROUBLE TEST:** Press this key to generate a Trouble on the selected detector.

**START ALARM TEST:** Press to generate an Alarm on the selected detector.

**START OBSCURATION TEST:** Press to perform an Obscuration Test on the selected Beam detector. (Beam detectors only.)

**START PREALARM TEST:** Press to perform a Prealarm Test on the selected device.

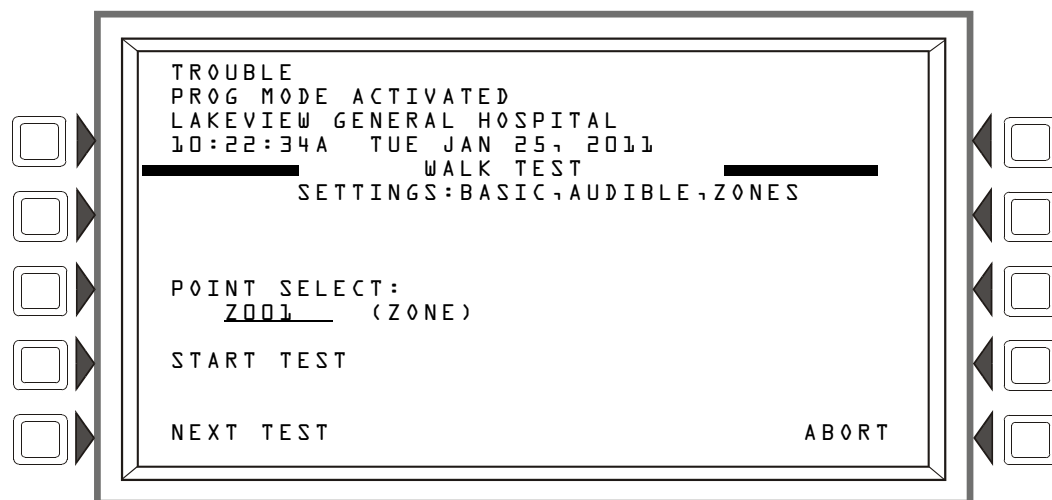
**ABORT:** Press to stop the Walk Test.



**NOTE:** The Trouble, Alarm and Obscuration tests described above are additional tools provided to ascertain the functionality of a detector. They are *not* a substitute for periodic maintenance and sensitivity verification per NFPA 72.



## 4.6.5 Zone Walk Test Activation

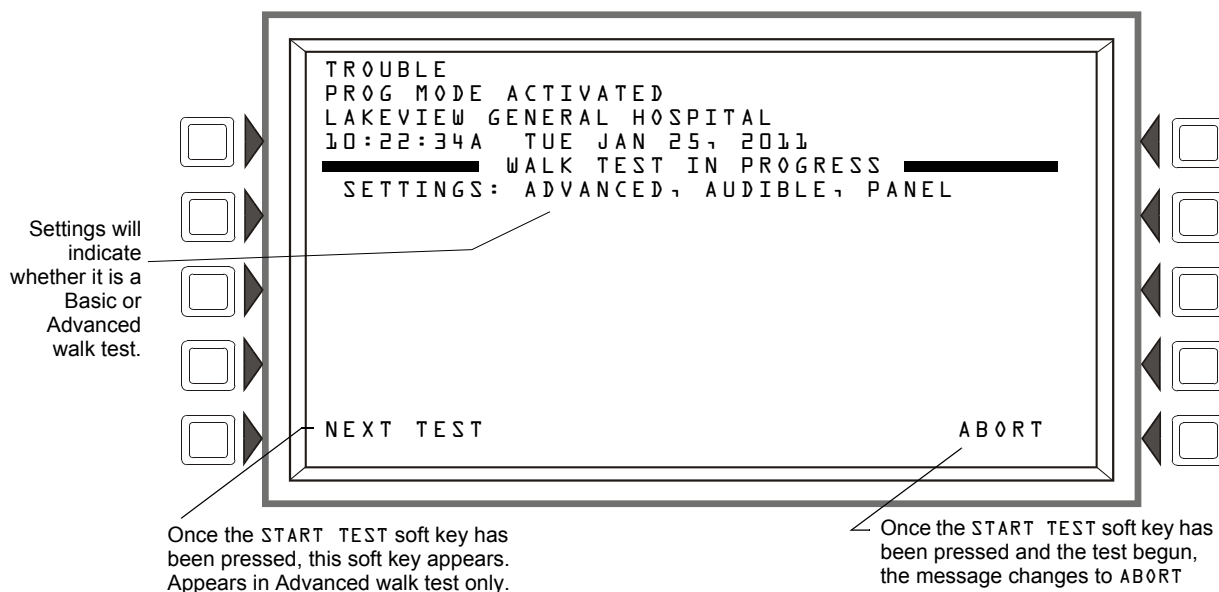


**Figure 4.15 Zone Walk Test Selection Screen**

**POINT SELECT:** Press to enter a zone number that will be put into Walk Test. When the panel finds that zone in the first position of a device's CBE map, that device will be put in Walk Test mode.

**START TEST:** Press to begin Walk Test using the chosen parameters. Once Walk Test has begun, this soft key becomes **ABORT**, and can be pressed at any time to exit Walk Test.

### Walk Test In Progress Screen



**Figure 4.16 Walk Test In Progress Screen**

## 4.6.6 Aborting Walk Test

When the “Abort” option is selected, the fire panel will evaluate the system to see if any devices remain in the “ACTIVE” state. This screen appears when there are active devices that remain when aborting Walk Test:

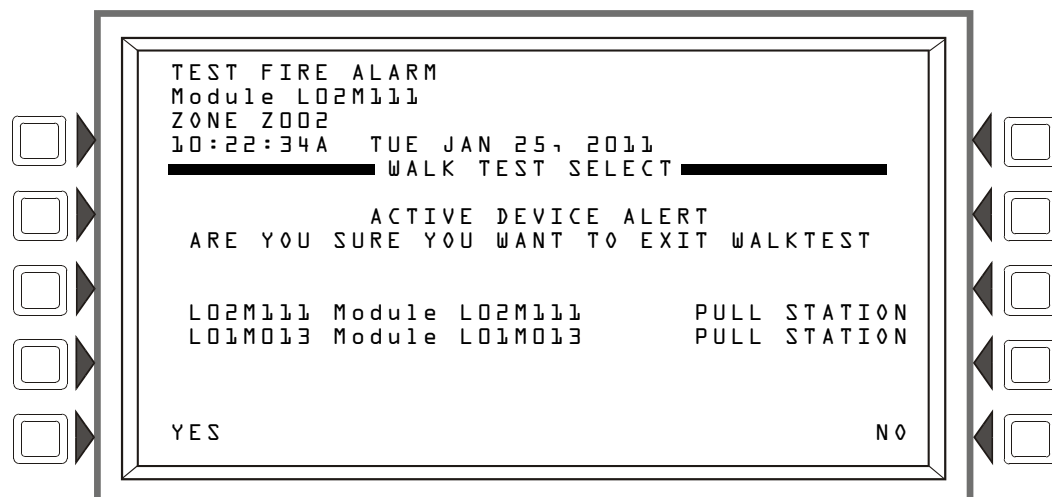


Figure 4.17 Active Device Alert Screen

### Soft Keys

**YES:** Press this key to exit Walk Test with the devices remaining active. Once Walk Test is exited, the fire panel will act as if the devices are newly activated and respond accordingly.

**NO:** Press this key to remain in Walk Test. This will provide the opportunity to clear the active devices.

## 4.7 Program Time/Date

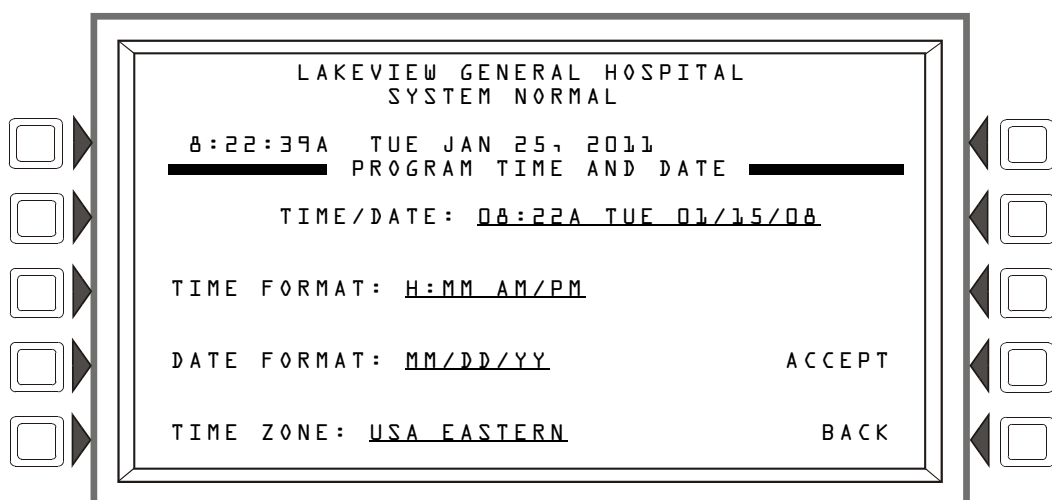


Figure 4.18 Program Time and Date Screen

### Soft Keys

**TIME/DATE:** Press to bring the cursor to the time/date field. The current time and date will be displayed using the current format. Change the values using the keypad.

**TIME FORMAT:** Press to scroll through a list of formats as follows; HH:MM AM/PM; H:MM AM/PM; HH:MM; and H:MM. Stop at the desired format.

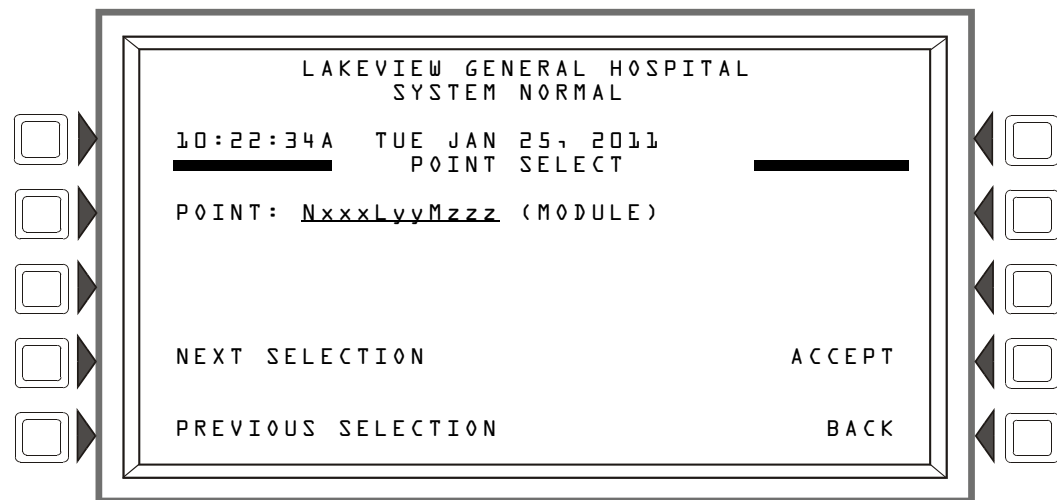
**DATE FORMAT:** Press to toggle between MM/DD/YY and DD/MM/YY formats. Stop at the desired format.

**TIME ZONE:** Press to scroll through a list of 34 time zone selections. Stop at the appropriate zone.

**ACCEPT:** Press to save changes made on this screen and to return to the previous screen.

## 4.8 Control On/Off Point Select

This screen may be used to force an SLC control module or general zone off if it is on, or on if it is off.



**Figure 4.19 Control On/Off Point Select Screen**

### Soft Keys

**P0INT:** Press this soft key to enter the point address or general zone number (except Z000) to be forced on or off.



**NOTE:** A module with a releasing Type ID can not be forced.

**NEXT/PREVIOUS SELECTION:** Press to progress to the next or previous point on the loop, or the next or previous general zone.

**ACCEPT:** Press to continue to the Control On or Control Off screen.

### 4.8.1 Control Off

One of the following two screens will display when a point or general zone is selected and accepted in the previous screen.

If the selected point or zone is active, the Control Off screen will appear.

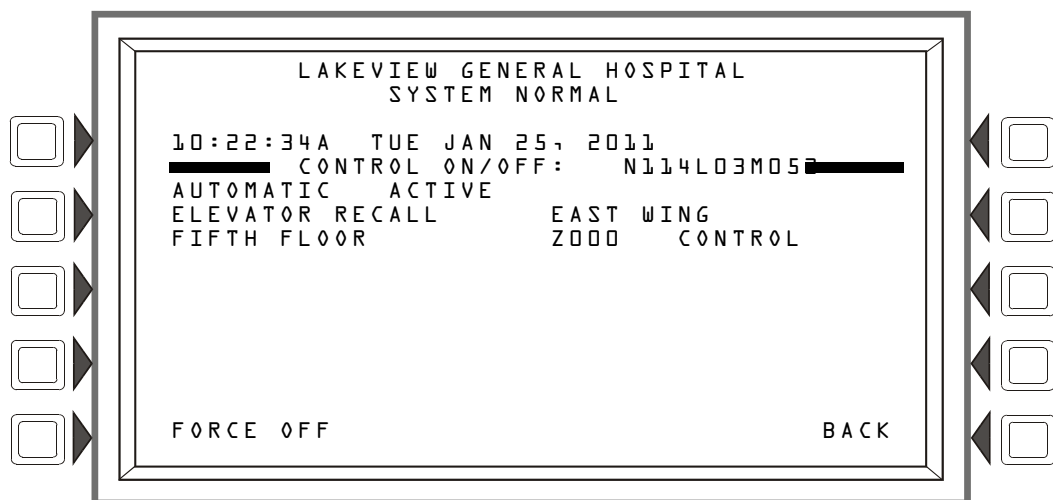


Figure 4.20 Control Off Screen

**Soft Keys**

**FORCE OFF:** Press this soft key to change the state of the control module or general zone from **AUTOMATIC ACTIVE** to **AUTOMATIC INACTIVE**.



**NOTE:** A module with a releasing Type ID cannot be forced.

**4.8.2 Control On**

If the selected point or zone is inactive, the Control On screen will appear:

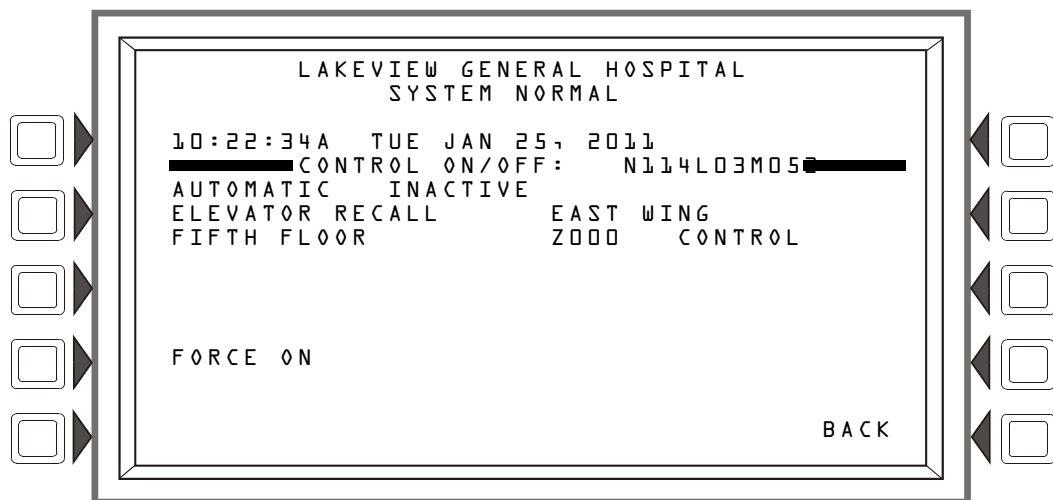


Figure 4.21 Control On Screen

**Soft Keys**

**FORCE ON:** Press this soft key to change the state of the control module or zone from **AUTOMATIC INACTIVE** to **AUTOMATIC ACTIVE**.

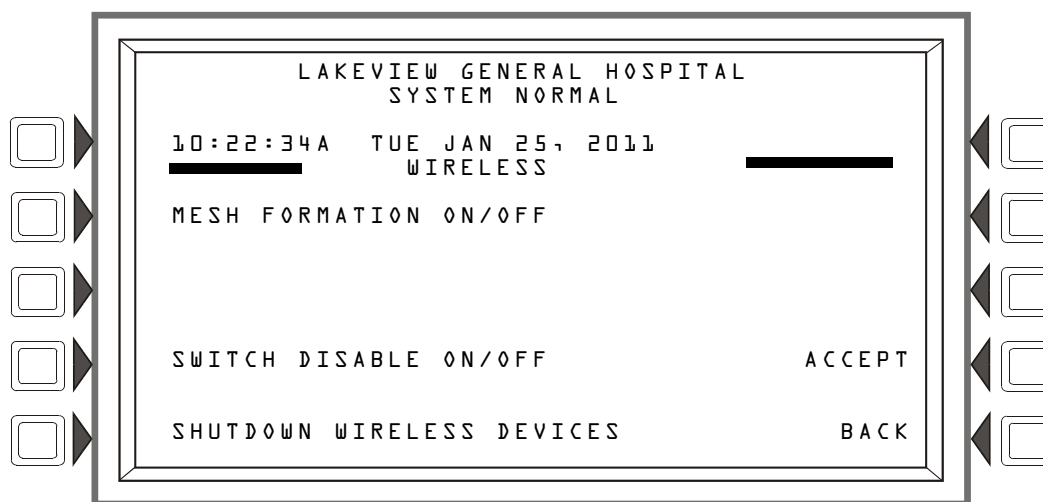
## 4.9 Wireless

The NFS2-3030 can communicate with a wireless network via the FWSG. Refer to the *SWIFT™ Network Manual* for additional information on wireless programming.



**NOTE:** The FWSG as part of the wireless network has been tested for compliance with the Federal Communications Commission (FCC) requirements of the United States Government. This product has not been evaluated for use outside the USA. Use of this system outside the USA is subject to local laws and rules to which this product may not conform. It is the sole responsibility of the user to determine if this product may be legally used outside the USA.

The following screen is displayed when WIRELESS is selected on the second Alter Status screen:



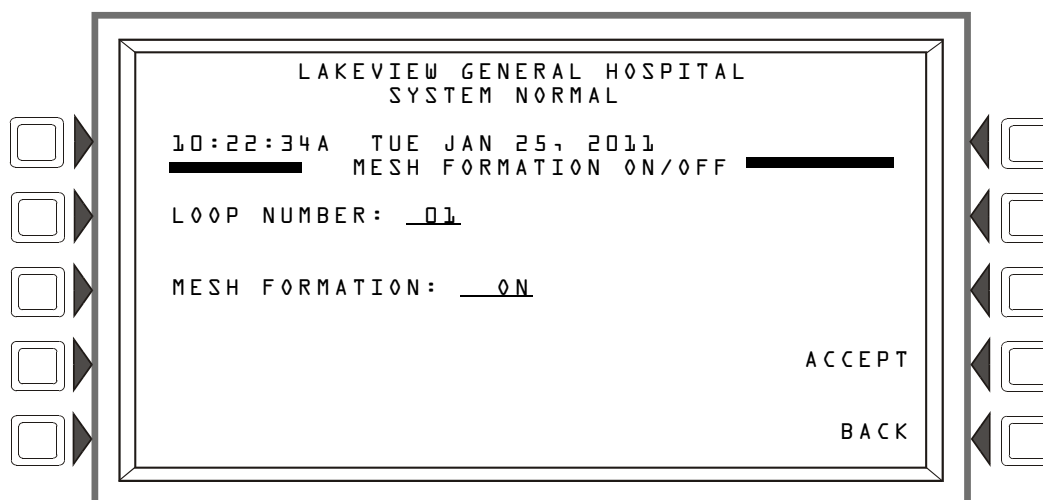
**Figure 4.22 Wireless Programming Screen**

### Soft Keys

**MESH FORMATION:** Press this soft key to display the Mesh Formation screen.

**SWITCH DISABLE:** Press to display the Switch Disable screen

**SHUTDOWN WIRELESS DEVICES:** Press to display the Shutdown Wireless Devices screen.

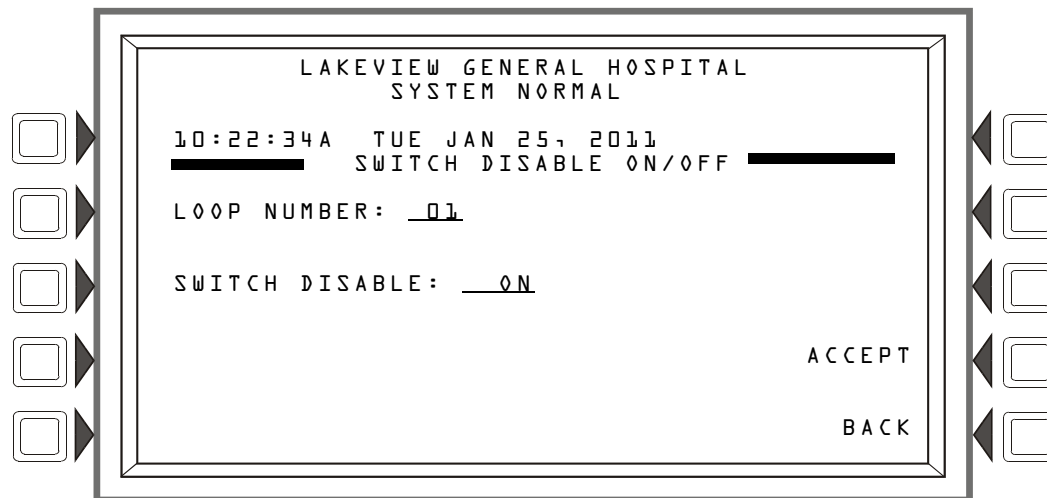


**Figure 4.23 Mesh Formation Screen**

**Soft Keys**

**LOOP NUMBER:** Press to select the loop to enable or disable wireless mesh formation.

**MESH FORMATION:** Press to form a wireless communication mesh surrounding the FWSG. This is required to establish communication with the wireless devices to the fire panel. Settings are **ON** and **OFF**. If **ON**, when accepted, a command to start mesh formation is sent to all FWSG units on the selected loop. If **OFF**, when accepted, a command to stop mesh formation is sent to all FWSG units on the selected loop.

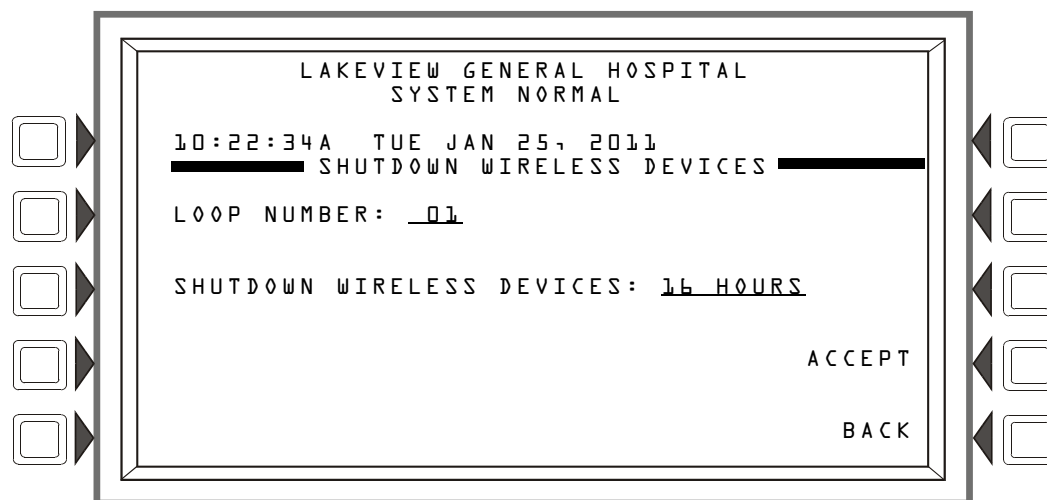


**Figure 4.24 Switch Disable Screen**

**Soft Keys**

**LOOP NUMBER:** Press to select the loop to enable or disable magnetic switches.

**SWITCH DISABLE:** Press to disable the magnetic sensor on the FWSG. Once disabled, a password is required for access to the FWSG using SWIFT™ Tools. Settings are **ON** and **OFF**. If **ON**, the magnetic sensor switches for the FWSG are disabled and a password is required to access wireless commands. If **OFF**, The magnetic sensor switches for the FWSG are enabled and no password is needed to access the wireless commands.



**Figure 4.25 Shutdown Wireless Devices Screen**

**Soft Keys**

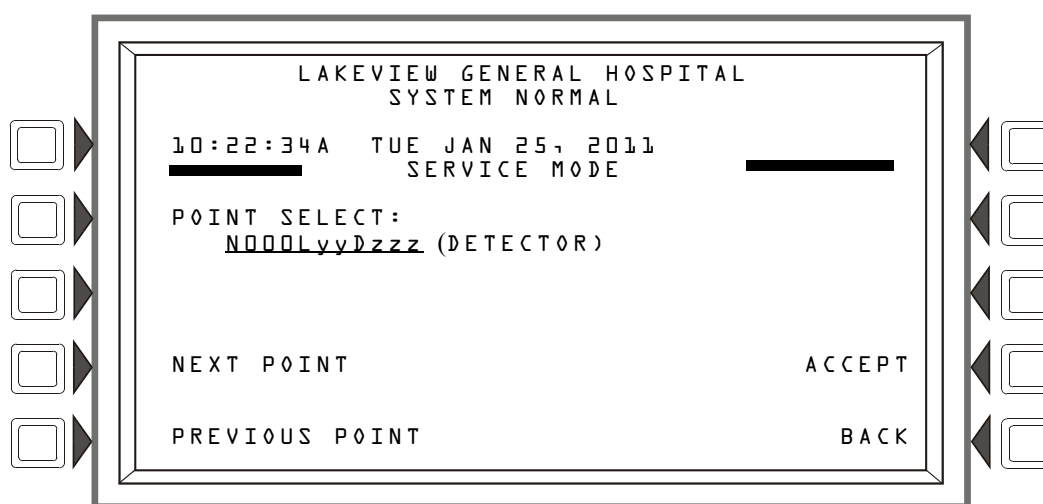
**LOOP NUMBER:** Press to select the loop containing the wireless devices that are to be shutdown.

**SHUTDOWN WIRELESS DEVICES:** Select the duration of time in which the wireless devices on the selected loop will be shutdown. The range is from 30 minutes to 24 hours. The wireless devices on the selected loop will be shutdown for the duration of the time selected.

When in wireless shutdown, fire protection is compromised. All wireless devices will not communicate with the FWSG until the time specified expires.

**4.10 Service Mode FFAST Detector**

An aspiration detector can be placed in Service Mode when maintenance is performed on the device. When in service mode, the panel will display a **SERVICE MODE** point trouble for the SLC point(s) associated with the FFAST detector. For maintenance information, refer to the *FSA-8000 FFAST Installation and Maintenance Instructions* document ( ).



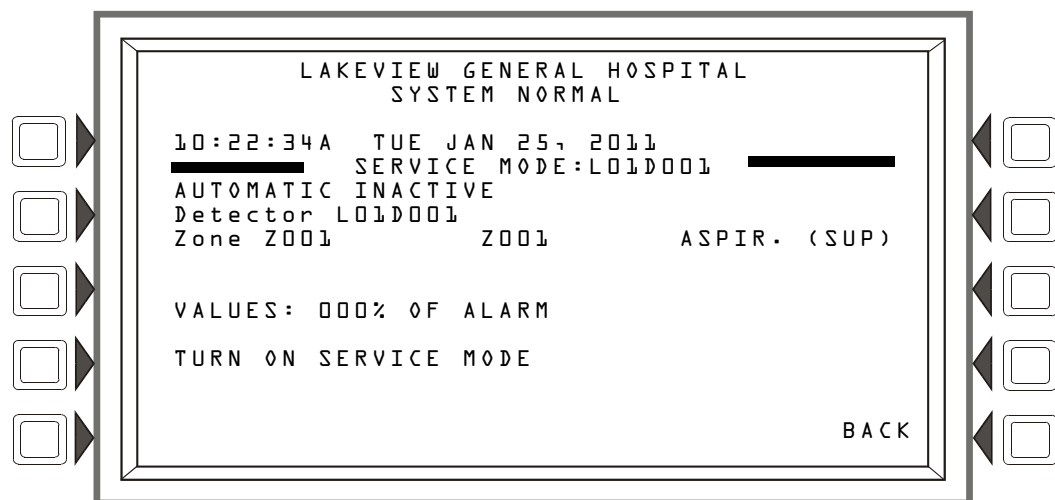
**Figure 4.26 Service Mode Point Select Screen**

**Soft Keys**

**POINT:** Press this soft key to select the aspiration detector that will be placed in Service Mode.

**NEXT/PREVIOUS POINT:** Press to progress to the next or previous point on the loop.

**ACCEPT:** Press to continue to the second Service Mode screen.



**Figure 4.27 Service Mode Screen**



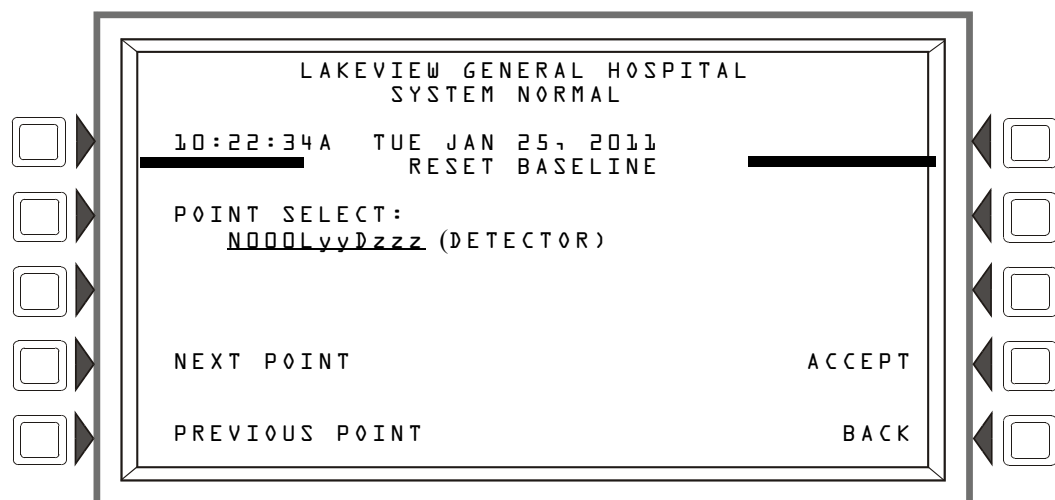
**NOTE:** If the detector selected is not an aspiration detector, the fire panel will display the message NOT A FAAS DETECTOR.

#### Soft Keys

**TURN ON SERVICE MODE:** Press this soft key to turn on Service Mode for the aspiration detector displayed. When maintenance is complete and the device is ready to return to service, return to this screen to turn off Service Mode.

## 4.11 Reset Baseline FAAS Detector

Once the detector has acclimated to its environment, it can be reset to a new baseline threshold level. This will adjust the aspiration detector so that its current value is the starting threshold reference.



**Figure 4.28 Reset Baseline Point Select Screen**

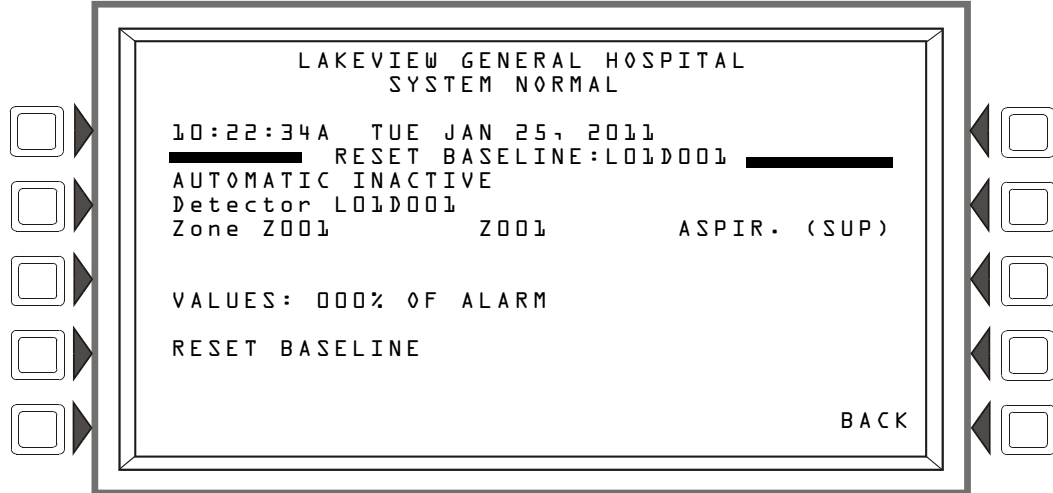
#### Soft Keys

**P0INT:** Press this soft key to select the aspiration detector that will be reset.



NEXT/PREVIOUS POINT : Press to progress to the next or previous point on the loop.

ACCEPT : Press to continue to the second Reset Baseline screen.



**Figure 4.29 Service Mode Screen (2)**



**NOTE:** If the detector selected is not an aspiration detector, the fire panel will display the message NOT A FAAST DETECTOR.

#### Soft Keys

**RESET BASELINE :** Press this soft key to reset the baseline threshold for the aspiration detector displayed. The VALUES display will show 000% OF ALARM.

# Section 5: Service Screens

## 5.1 Version Information

Software version information may be displayed by pressing the Lamp Test special function key on the keyboard for more than 5 seconds. The following three screens will appear in succession while the Lamp Test key is pressed.

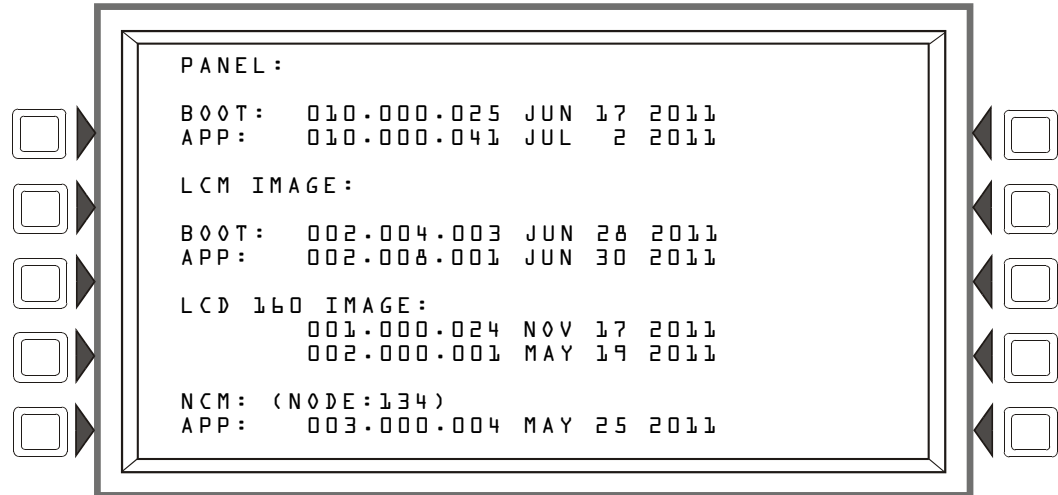


Figure 5.1 Version Screen 1

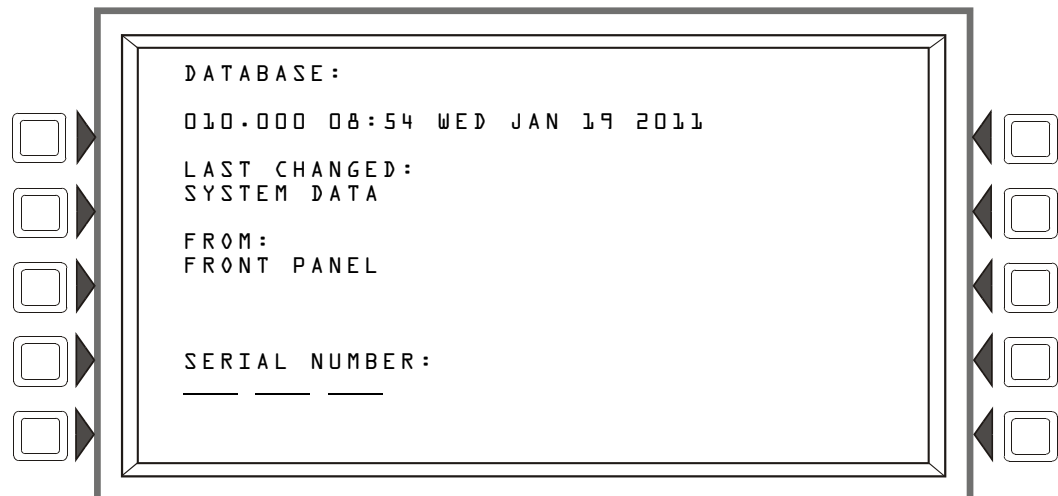


Figure 5.2 Version Screen 2

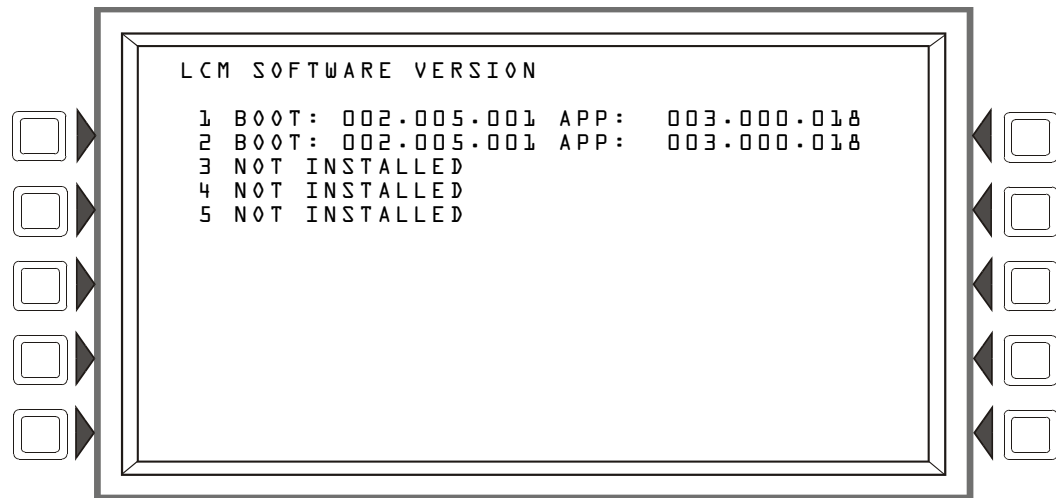


Figure 5.3 Version Screen 3

## 5.2 Power-up Screen

The Power-up screen appears when the panel is powering up. A series of self-tests are performed internally: the tests and the results of the tests appear on the screen as they are completed.

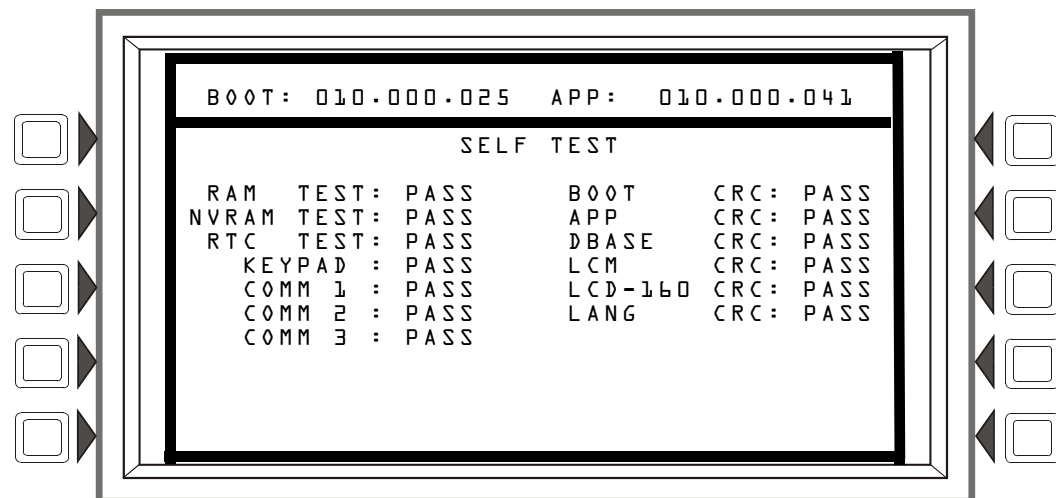


Figure 5.4 Self Test Screen



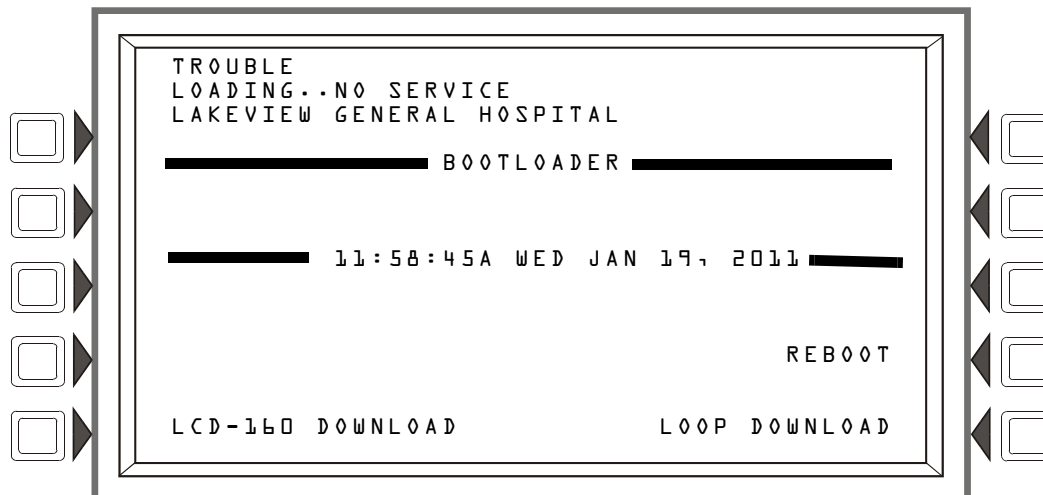
**NOTE:** “LCM” refers to the code resident in the CPU2-3030, not the code that is programmed into the LCM-320.



**NOTE:** “LCD-160” refers to the code resident in the CPU2-3030, not the code that is programmed into the LCD-160.

## 5.3 Bootloader Screen

This screen is used for LCD-160 and Loop downloads. To display this screen, press the RESET key during the entire power-up self-testing process, then release the key.



**Figure 5.5 Bootloader Menu Screen**

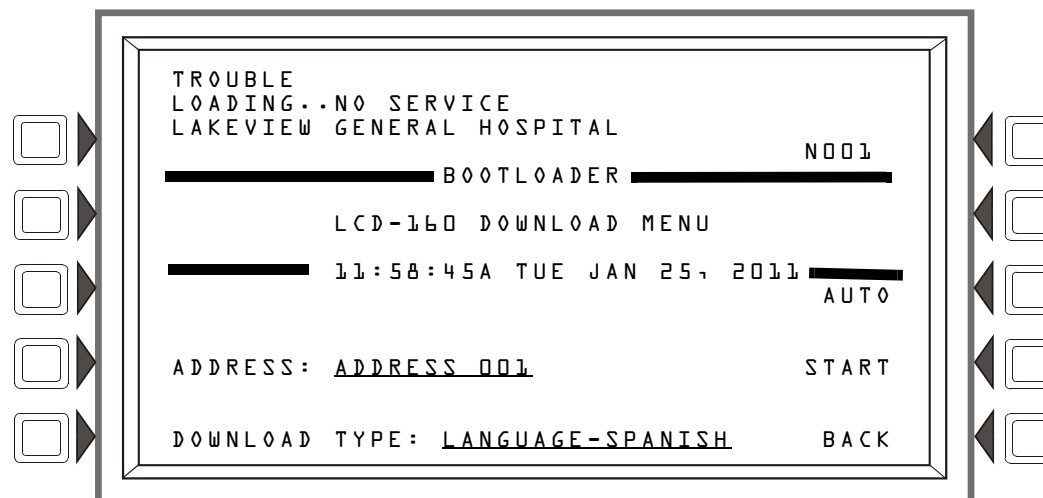
**LCD-160 DOWNLOAD:** Press this soft key to display the LCD-160 Download menu screen.

**REBOOT:** Press this soft key to reboot the panel, and exit the bootloader screen.

**LOOP DOWNLOAD:** Press this soft key to display the Loop Download Menu screen.

### 5.3.1 LCD-160 Download Menu

The language and banner displayed on LCD-160s can be programmed at this screen.



**Figure 5.6 LCD-160 Download Menu Screen**

**ADDRESS:** Press this soft key to scroll through to the desired LCD-160 address. “All” means all addresses. Default: ADDRESS 001.

Shortcut: Type 1 on the keyboard, which jumps to address 10, or type 2 for twenty, 3 for thirty, 0 to reset back to 1. Type an asterisk (\*) to select all addresses.

**DOWNLOAD TYPE** : Press this soft key to scroll through the languages (LANGUAGE-ENGLISH, LANGUAGE-HEBREW, LANGUAGE-PORTUGUESE, LANGUAGE-SPANISH), BANNER, APP and BOOT. Stop at the desired selection.

Choose a language to change LCD-160s selected at the ADDRESS field to display in that language.

Choose BANNER to add the panel banner to those LCD-160 displays selected at the ADDRESS field.

Select APP to download an application file to the selected LCD-160(s).

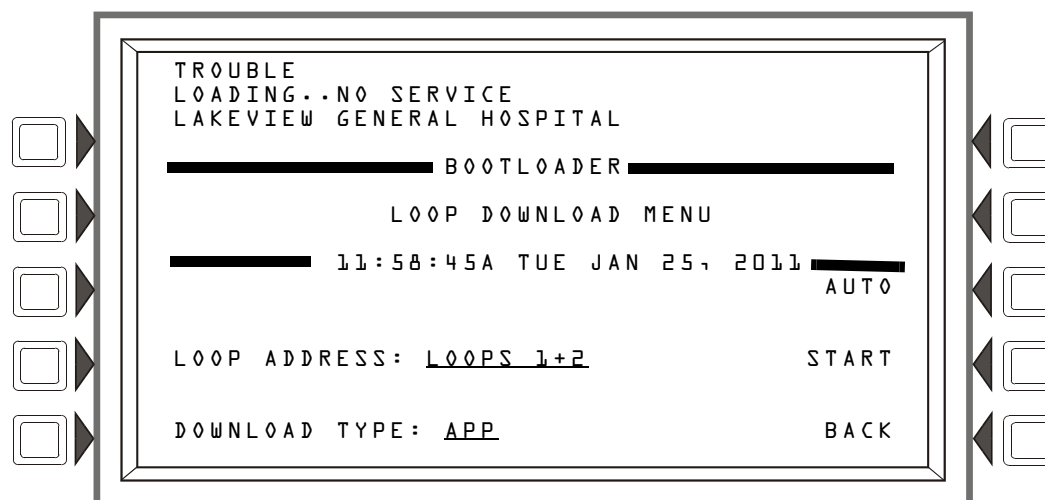
Select BOOT to download a boot file to the selected LCD-160(s).

**AUTO** : Press this soft key to automatically download to the LCD-160 the most up-to-date language, bootloader, and application from the panel.

**START** : Press this soft key to begin the download.

### 5.3.2 Loop Download Menu

This screen allows the programmer to select loops for downloading applications and/or boot programming.



**Figure 5.7 Loop Download Menu Screen**

**LOOP ADDRESS** : Press this soft key to scroll through the Loops. Stop at the appropriate pair, or select ALL.

**DOWNLOAD TYPE** : Press this soft key to scroll through the download types. Stop at the appropriate type. Selections are: APP, BOOT, or APP/BOOT.

Select APP to download an application file to the selected loops.

Select BOOT to download a boot file to the selected loops.

Select APP/BOOT to select both for downloading.

**AUTO** : Press this soft key to automatically download to the selected loop(s) the most up-to-date applications or boot programming from the panel.

**START** : Press this soft key to begin the download.



# Appendix A: Menu Hierarchy

## A.1 Screens Overview

### MAIN MENU

#### **Event Counts Display**

- More Information

#### **Multiple Event List**

#### **History Select**

- All Events
- Alarms Only
- Troubles Only
- Supervisory Only
- Security/Other
- Time/Date Interval
  - Time & Date Range Select
- Point Range
  - Point Range Select

#### **Read Status**

- Detector
- Module
- Panel Circuit
- Bell Circuit
- Zone
- Logic Zone
- ACS Point
- PAM Point
- Release Zone
- Special Zone
- Trouble Zone
  - DAA Speaker Circuit

#### **Program/Alter Status**

- Panel Program
  - Network Parameters
    - Node Number
    - Node Label
    - Style
    - Ch. A Threshold
    - Ch. B Threshold
    - IP Access
  - Network Mapping
    - Autoprogram
  - Panel Settings (Panel Settings (1) Screen)
    - Local Control
    - Piezo
    - Proprietary Supervising Station
    - Event Ordering
    - Display Address
    - Reminder Menu
      - Trouble Reminder
  - More (Panel Settings (2) Screen)
    - LCM Local Mode
    - Power Management Mode
    - DCC Participation

- Rapid All Call
- Default Settings
- More (Panel Settings (3) Screen)
  - Sounder Base Setup
    - Custom Tone Setup Screen
      - Pulse On Time
      - Period
      - Number Of Pulses
      - Tone Off Period
    - Network Display Mode
    - Drill Mode
  - More (Panel Settings (4) Screen)
    - Silenceable Waterflow
    - MN Priority Over Fire
    - Sounder Base Standby Power Mon
    - MN Control
  - More (Panel Settings (5) Screen)
    - Photo/CO Supervisory Latching
- Panel Timers
  - Verify Time
  - Maximum Verification Count
  - AC Fail delay
  - Silence Inhibit
  - Auto Silence
  - Verify=Prealarm
  - More
    - PAS
    - Presignal Delay
    - Default Timers
- LCD Programming
  - Brighter
  - Darker
  - Language
  - Backlight
  - Default
  - Current
- ACS Programming
  - Annunciator Type
  - Point Programming
    - Point
    - Mode
    - Source
- Supervision
  - Main PS AC Fail Address
  - Printer
  - CRT Baud rate
  - Auxiliary Trouble Reporting
  - Tamper Input
  - More
    - Terminal
- More
  - Password Change
    - Master Password
    - User Password
  - Weekly Occupancy Schedule
  - Remote Display Menu
    - Point Programming



- Display Point
  - Point Label
  - Local control
- Loop Configuration
  - Loop Point Programming
    - Loop Selection
      - Installed
      - Detector Poll
      - Module Poll
      - Rapid Poll
      - Wiring Style
      - Blink Mode
  - Custom Action Message
    - Custom Action Message Message
  - Event Logging
    - Non-Fire Activations
    - Output Activations
  - Holiday Menu
- Point Program
  - Detector Point Programming (1)
    - Type
    - FlashScan Type
    - Point Label
    - Extended Label
    - Zone Map
  - More (Detector Point Programming (2))
    - Custom Action Message
    - Alarm Verification
    - Local Mode
    - Weekly Occupancy Schedule
    - Multi-Detector
    - Sensitivity
      - Occupied Sensitivity Alarm
      - Occupied Sensitivity Prealarm
      - Unoccupied Sensitivity Alarm
      - Unoccupied Sensitivity Prealarm
  - More (Detector Point Programming (3))
    - Low Temp Enable
    - Prealarm
    - Silenceable
    - Intelligent Sounder
    - Sounder Base Setup
      - AUX Tone 1
      - AUX Tone 1 Control
      - AUX Tone 2
      - AUX Tone 2 Control
      - Volume
    - CO Pre-Alarm
- Module Point Programming
  - Module Type
  - Type Code Label
  - FlashScan Code Label
  - Point label
  - Extended Label
  - More (for a Monitor Type)
    - Custom Action Message

- Zone Map
- Alarm Verification
- Local Mode
- 4-20 Device Setup
  - 4mA Scale Value
  - 20mA Scale Value
  - Units
  - Hysteresis
  - Threshold Setup
    - Threshold Number
    - Threshold Value
    - Event
    - Trouble type
    - Event trigger
    - Latching
- More (for a Control Type)
  - Local Mode
  - Zone Map
  - Walk Test
  - Switch Inhibit
  - Silenceable
- General Zone Point Programming
  - Zone Label
  - Non-Resettable Control
  - Silenceable Zone
  - Precedence Participation
- Releasing Zone Programming
  - Delay Time
  - Abort Switch
  - Cross Zone
  - Soak Time
- Logic Zone Programming
  - Edit Logic Equation
    - Add Point/Zone
    - Add Logic Function
    - Add Time/Date
    - Delete Equation
- Trouble Zone Programming
  - Edit Logic Equation
    - Add Point/Zone
    - Add Logic Function
    - Add Time/Date
    - Delete Equation
- Annunciator Board Label
  - ACS Label
- Audio Point Programming
  - Master Volume
  - Auxiliary Volume
- Delete Program Menu
  - Clear Panel
  - Clear Loops
  - Delete Point
    - Point Select
  - Clear All Programming
  - Clear ACS

- Autoprogram Menu
  - Confirmation Screens
- Alter Status
  - Disable/Enable
    - Point Select
  - Detector Sensitivity
    - Sensitivity Select
      - Change Alarm/Prealarm Sensitivity
  - Clear Verify Counters
    - Clear Counters
  - Clear History
    - Alarm History
    - Event History
    - All History
  - Walk Test
    - Basic/Advanced
    - Silent/Audible
    - Parameter
    - Disable ACS Boards
  - Change Time/Date
    - Time Format
    - Date format
    - Time Zone
  - More
    - Control On/Off Point Select
      - Point
        - Force On/Off
- Wireless
  - Mesh Formation
  - Switch Disable
  - Shutdown Wireless Devices
- More
  - Service Mode FFAST Detector
  - Reset Baseline FFAST Detector

**Printer Functions**

- Programming
  - Print Programming Menu
  - Print Programming Menu (2)
- Active Points
  - Active Points Menu
- Walk Test
- Detector Maintenance Report
- Installed Points
  - Installed Points Menu
  - Installed Points Menu (Range)

# Appendix B: Releasing Applications



**WARNING:**

DO NOT RELY ON DISABLE TO DISABLE RELEASING POINTS DURING TESTING. RELEASING POINTS MUST BE PHYSICALLY DISCONNECTED.

## B.1 Releasing Zones

The control panel includes ten releasing zones (ZR00-ZR09) that can be used to control up to ten releasing operations. Each zone operates independently, and is fully programmable. To program a releasing zone, refer to Section 3.4.4, “Releasing Zone”, on page 62.

There are four releasing functions, outlined below, that can be defined by entering values in the associated fields during programming.

Function/Field	Explanation
Delay Time	<p>Delay Time is the time that elapses between activation of an initiating device and activation of all outputs mapped to the initiating device through a releasing zone. Delay Time can have a value of 0 to 60 (seconds). A value of 0 will result in immediate output activation upon activation of the initiating device. Following is a graphic representation of what happens when a delay timer is set to 15 seconds for releasing zone ZR02.</p> <p><b>NOTE: If cross-zoning is in effect, the delay time will not begin until the cross-zoning conditions are met. Refer to Appendix B.3.5, “Cross Zones”, on page 116 for more information.</b></p>
Abort Switch	<p>Selection of a 3-letter abort switch type code (ULI, IRI, NYC, or AHJ) defines the operation of an Abort Switch in that releasing zone. Refer to the specific abort switch type code heading in this appendix for details on how each functions.</p>
Cross Zone	<p>Select one of three Cross Zone types (Yes, Zone, or Heat), or No (not used). A Cross Zone requires tripping two or more initiating devices to activate the outputs mapped to a releasing zone. Refer to the Section B.3.5 on page 116 section of this appendix for details and examples.</p>
Soak Time (NFPA 16 Applications only)	<p>Soak Time specifies the length of time to dump releasing agents when a releasing zone activates. When the Soak Time expires, the control panel automatically shuts the releasing solenoids for the active releasing zone. Soak Time can have a value of 0 to 9999 seconds. If Soak Time is set to 0, the releasing solenoids will remain active until system reset. Following is a graphic representation of what happens when soak time is set to 300 seconds for releasing zone ZR02.</p>

## B.2 NFPA Releasing Applications

This control panel can be used for agent release or preaction/deluge control applications. In a properly configured system with compatible, listed actuating and initiating devices, this control panel complies with the following NFPA standards for installation in accordance with the acceptable standard:

Standard	Covers
NFPA 13	Sprinkler Systems
NFPA 15	Water Spray Systems
NFPA 16	Foam-water Deluge and Foam-water Spray Systems
NFPA 17	Dry Chemical Extinguishing Systems
NFPA 17A	Wet Chemical Extinguishing Systems
NFPA 2001	Clean Agent Fire Extinguishing Systems

**Table B.1 NFPA Standards for Releasing Applications**

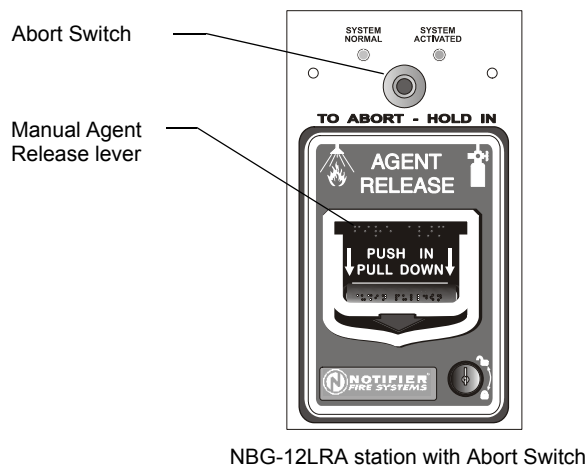
## B.3 Abort Switches

The control panel provides for four types of abort switches - ULI, IRI, NYC, and AHJ - each of which will affect the operation of the delay timer in the releasing zone. For example, an NYC Abort Switch for releasing zone ZR05 affects only the delay timer in ZR05.

When an initiating device activates, pressing and holding the abort switch will prevent the control panel from sending the command to dump releasing agents when the Delay Time expires.

Requirements for using an abort switch include the following:

- A monitor module must be connected to a UL-listed abort station, such as the NBG-12LRA shown below.
- An Abort switch can only be associated with one (1) Releasing Zone.
- The monitor module must be programmed with the Type Code ABORT SWITCH.
- An abort switch shall not be used with a preaction system.



**Figure B.1 UL-listed Abort Station**

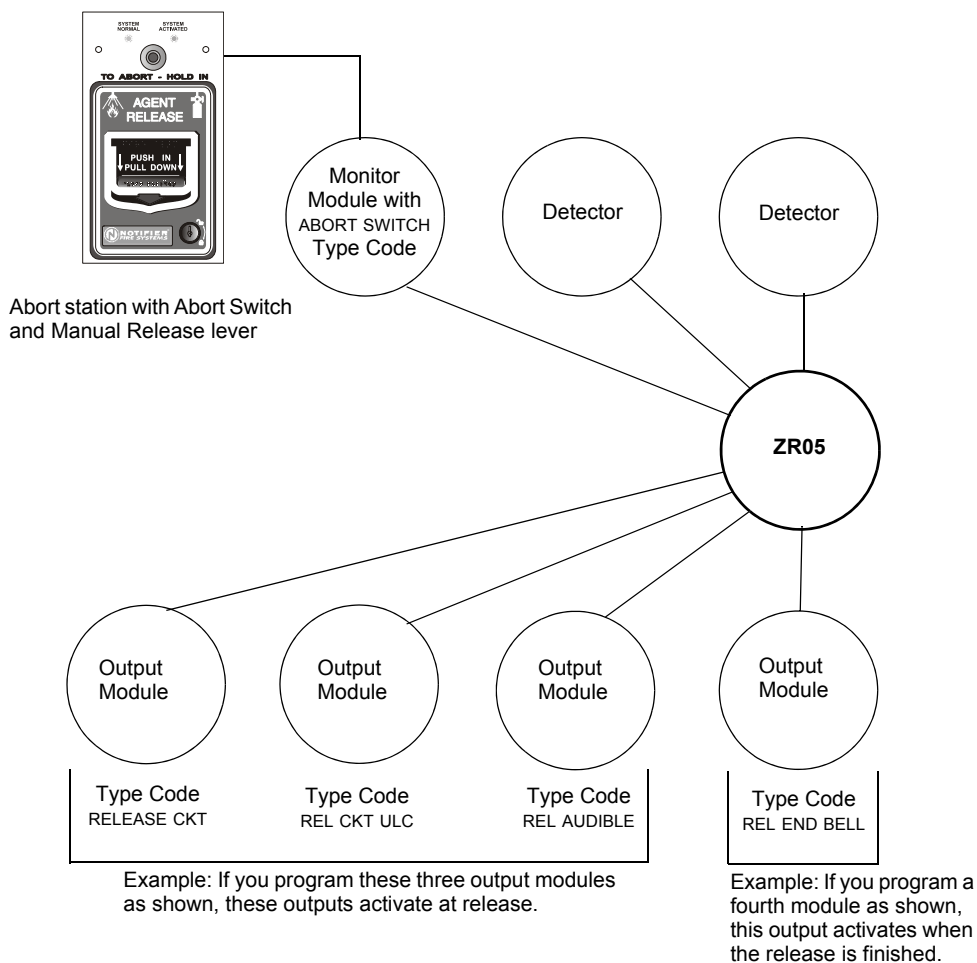
This section contains information on each type of abort switch.

### Example of an Abort Switch Application

The figure below contains an illustration for an abort switch application configuration using releasing zone ZR05 as an example. The configuration includes:

- A monitor module wired to an abort station and programmed with the Type Code ABORT SWITCH
- All initiating devices and outputs with a common releasing zone in their zone maps - ZR05 in the example shown
- A fully programmed releasing zone - releasing zone ZR05 in the example shown. (Refer to Section 3.4.4, “Releasing Zone”, on page 62 for programming information.)

In the following example, when an initiating device activates (one of the two detectors or the pull station), pressing and holding the abort switch while the delay time is in effect will prevent the control panel from sending the command to dump releasing agents when the delay time expires. The abort switch selection (ULI, IRI, NYC, or AHJ) determines the function of the abort switch.



**Figure B.2 Example of a Basic Configuration for an Abort Switch**

### B.3.1 ULI Abort Switch

A ULI Abort Switch has a standard UL-type delay timer that complies with UL Standard 864.

When an alarm initiates in the programmed releasing zone, the abort switch can be pressed while the delay timer continues to count down, and held for as long as necessary. If the abort switch is pressed after the delay timer has expired, the abort switch has no effect. Releasing the the abort switch starts a countdown by a 10-second ULI timer. When the 10-second ULI timer expires, the control panel activates the releasing zone outputs.

Program selections for this releasing zone

Delay Time: 15 seconds  
 Abort Switch: ULI  
 Cross Zone: N  
 Soak Time: 0

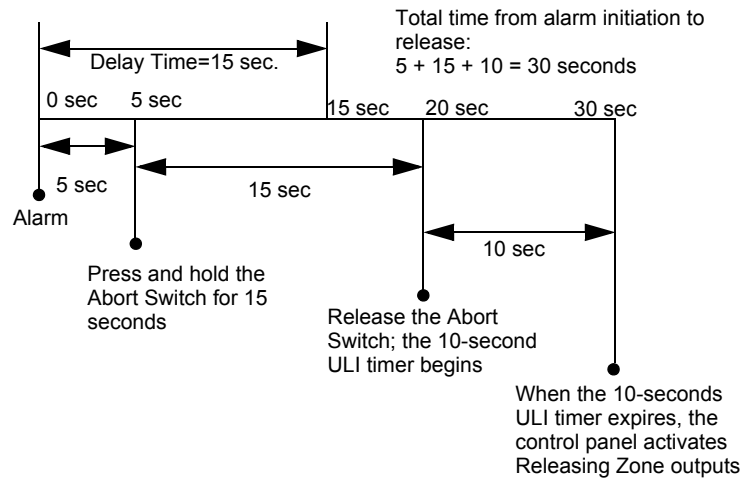


Figure B.3 ULI Abort Switch

## B.3.2 IRI Abort Switch

An IRI Abort Switch has a standard UL-type delay timer that complies with UL Standard 864, operating like ULI but with additional functions for Cross Zones. Refer to “How Cross Zones Work” on page 116 in this appendix for more information on cross zones.

When the first alarm occurs in a releasing zone programmed with a cross-zone code, pressing the abort switch will prevent activation of the releasing zone should a second alarm occur while the switch is held.

When the abort switch is released, if a second alarm has occurred while the switch was held, the ten-second IRI timer activates immediately, and the control panel activates the releasing zone outputs at the end of the IRI timer countdown.

When the abort switch is released and a second alarm has not occurred while the switch was held, the panel waits for the cross-zone conditions to be met before activating the releasing zone.



### WARNING:

THE IRI ABORT SWITCH WILL ONLY WORK IF IT IS PUSHED BEFORE THE SECOND ALARM OCCURS. IF IT IS PUSHED AFTER THE SECOND ALARM, THE RELEASING ZONE WILL ALREADY HAVE BEEN ACTIVATED, AND THE SWITCH WILL HAVE NO EFFECT.

Program selections for this releasing zone

Delay Time: 15 seconds  
 Abort Switch: IRI  
 Cross Zone: Z  
 Soak Time: 0

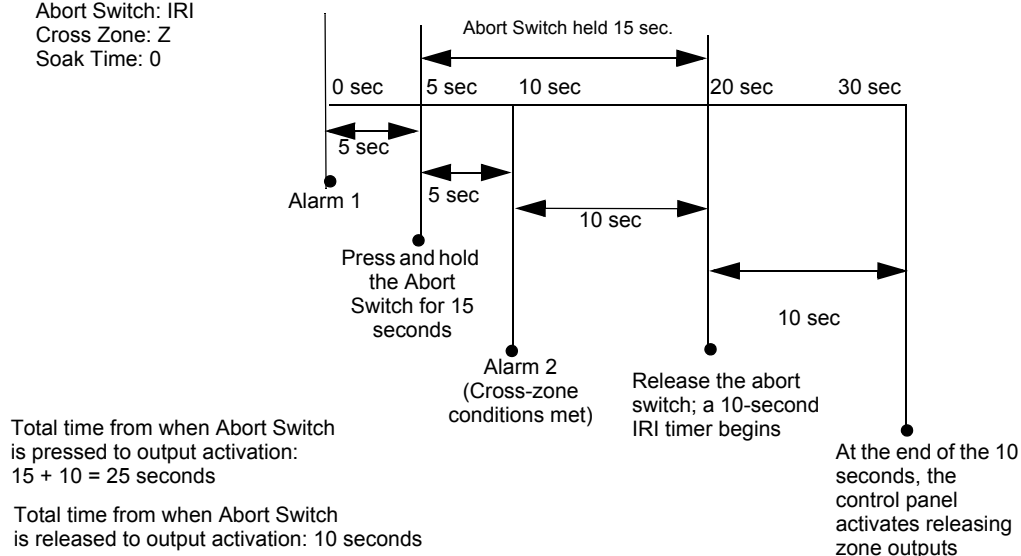


Figure B.4 IRI Abort Switch



### B.3.3 NYC Abort Switch

An NYC Abort Switch has a standard NYC delay timer that adds 90 seconds to the programmed Delay Time.



**NOTE:** An NYC timer does not comply with UL Standard 864.

When an alarm initiates in the programmed releasing zone, pressing and holding the abort switch stops the delay timer countdown. The delay timer restarts at the beginning of its countdown when the abort switch is released. When the Delay Time expires, the 90-second NYC timer starts counting down. When both timers expire, the control panel activates releasing zone outputs.



**NOTE:** 120 seconds is the maximum delay after the abort switch is released. If the Delay Time plus the NYC delay time of 90 seconds exceeds 120 seconds, the releasing zone outputs will still be activated at 120 seconds after the abort switch is released.

#### Example 1 - Delay Time Does Not Exceed 120 Seconds

Program a Delay Time of 15 seconds and an Abort Switch type of NYC. The releasing zone activates and the 15-second delay timer starts. Ten seconds into the delay timer countdown, press and hold the abort switch for 30 seconds, then release the abort switch. The control panel restarts the delay timer at 15 seconds and adds the NYC delay of 90 seconds. The delay timers will both expire at 105 seconds, and releasing zone outputs will begin releasing at that time. Following is a graphic example of a NYC Abort Switch and a delay timer programmed to a releasing zone.

Program selections for this releasing zone

- Delay Time: 15 seconds
- Abort Switch: NYC
- Cross Zone: N
- Soak Time: 0

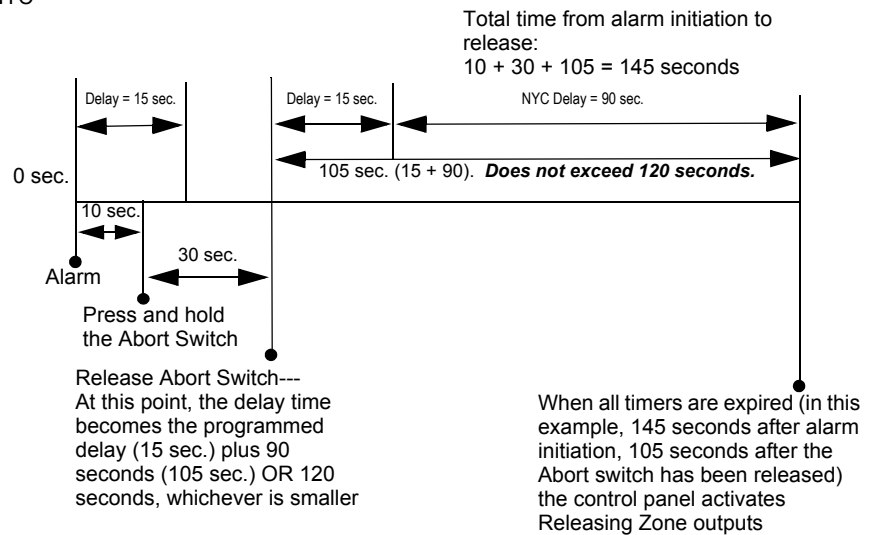


Figure B.5 NYC Abort Switch -Example 1

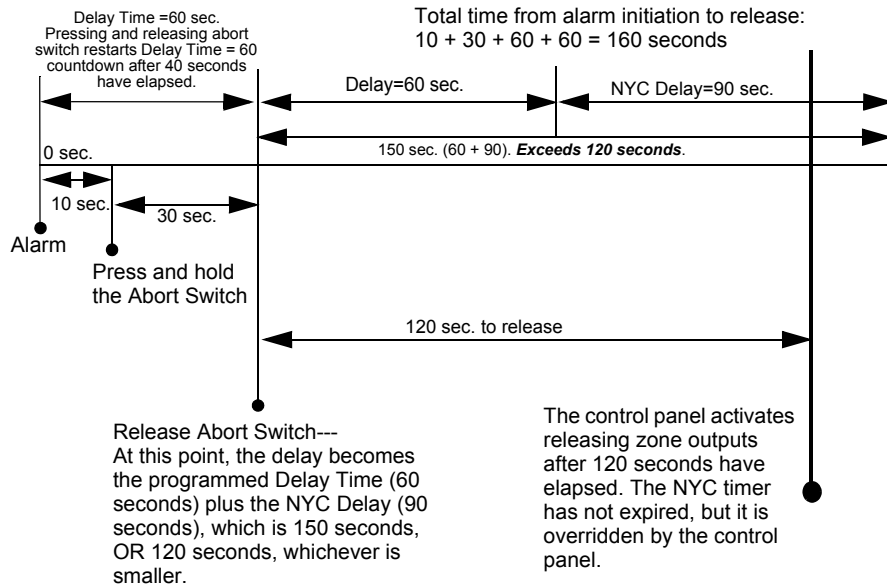
#### Example 2 - Delay Time Exceeds 120 Seconds

Program a Delay Time value of 60 seconds and an Abort Switch type of NYC. The releasing zone activates and the 60-second delay timer starts. Ten seconds into the Delay Time countdown, press and hold the abort switch for 30 seconds, then release the abort switch. The control panel restarts the delay timer at 60 seconds and adds the NYC delay of 90 seconds. The delay timers will both

expire at 150 seconds: however, this time exceeds the maximum of 120 seconds, so the releasing zone outputs will begin releasing at 120 seconds, not at 150. Following is a graphic example of an NYC Abort Switch and a delay timer programmed to a releasing zone.

Program selections for this releasing zone

- Delay Time: 60 seconds
- Abort Switch: NYC
- Cross Zone: N
- Soak Time: 0



**Figure B.6 NYC Abort Switch -Example 2**

### B.3.4 AHJ Abort Switch

An AHJ (Authority Having Jurisdiction) Abort Switch has a delay timer that restores the programmed Delay Time.



**NOTE:** An AHJ timer does not comply with UL Standard 864.

When an alarm initiates in the programmed releasing zone, the programmed Delay Time starts. Pressing and holding the abort switch suspends the delay timer. When the abort switch is released, the control panel restores the value of the programmed Delay Time and the delay timer counts down. When the Delay Time expires, the control panel activates releasing zone outputs.

Program selections for this releasing zone

- Delay Time: 60 seconds
- Abort Switch: AHJ
- Cross Zone: N
- Soak Time: 0

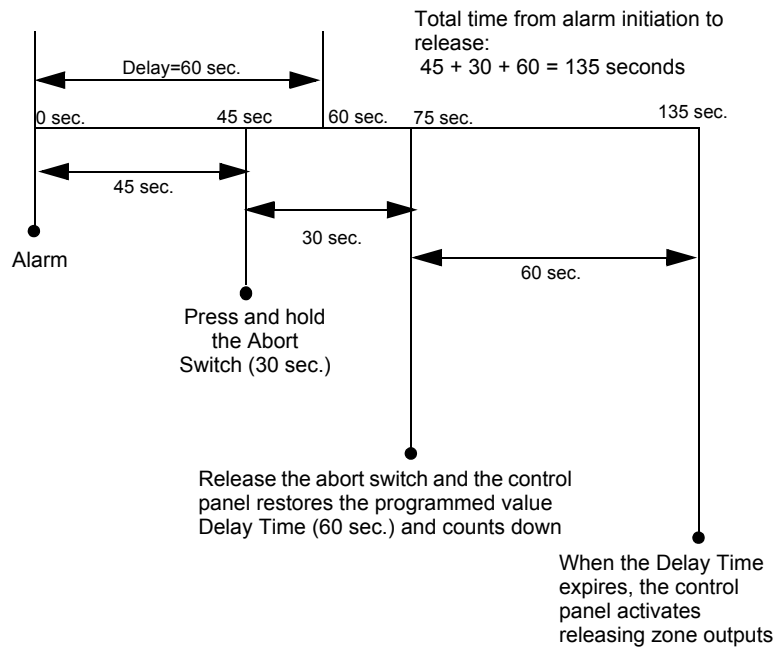


Figure B.7 AHJ Abort Switch

## B.3.5 Cross Zones

### Purpose of Cross Zones

Programming the Cross Zone releasing function can set the control panel to activate a releasing zone and any output mapped to that releasing zone only after a predetermined sequence of events occurs.



**NOTE:** The FACP considers only the **Primary Zone** (the first zone in a point's zone map) to determine whether conditions have been met for Cross Zone type Zone.



**CAUTION:** MAPPING OF ANY INPUTS THAT ARE NOT ASSOCIATED WITH A **PRIMARY ZONE** COULD CAUSE IMPROPER OPERATION OF CROSS ZONE TYPE ZONE.

A summary of the types of Cross Zones and the conditions for activating a releasing zone:

Type	Activates when
No	A Cross Zone has not been selected. An alarm from any initiating device mapped to the releasing zone activates it.
Yes	Two or more initiating devices are in alarm that are mapped to the same releasing zone.
Zone	Two or more initiating devices are in alarm that are mapped to two different Primary Zones and that are also mapped to the same releasing zone. Note that the FACP considers only Primary Zones to determine whether releasing zone activation should occur.
Heat	At least one smoke detector mapped to a releasing zone is in alarm and at least one heat detector mapped to the same releasing zone is in alarm.

### How Cross Zones Work

Below is an illustrated example of how Cross Zones work, using five Cross Zone selections (four detectors and an SLC output module mapped to Releasing Zone ZR01):

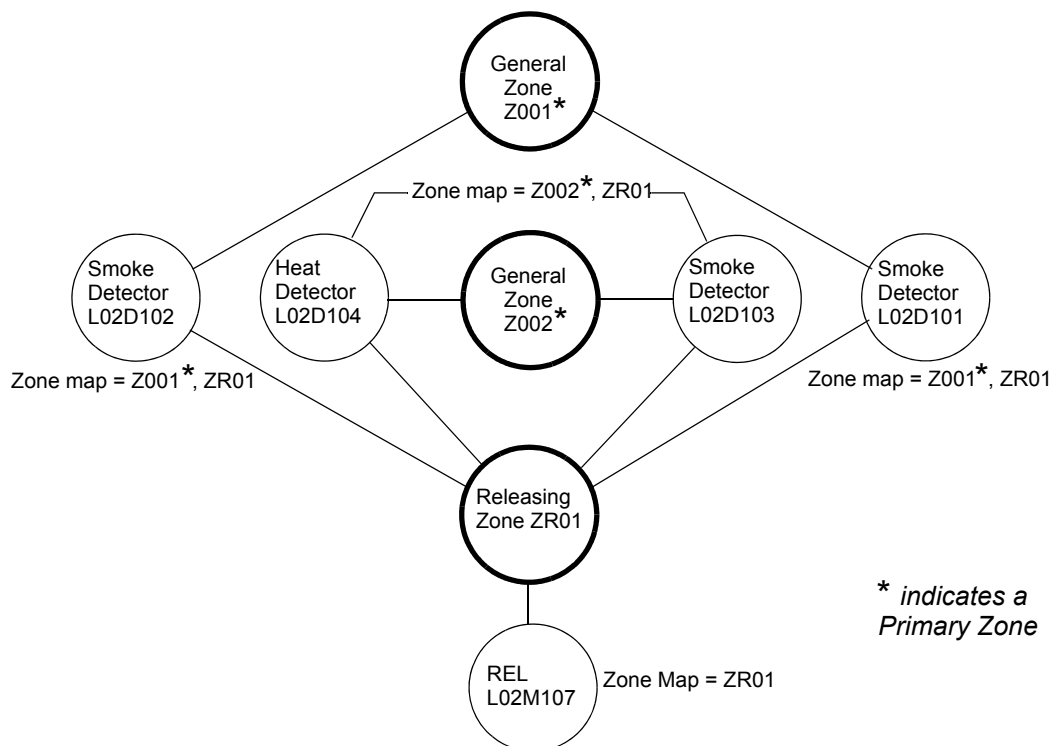


Figure B.8 Illustrated Example of Cross Zone Programming

Each Cross Zone option and the conditions required to activate releasing zone ZR01 are shown in the table below, according to the example in Figure B.8.

Cross Zone Selection (Cross=)	Condition(s) Required to Activate the Releasing zone
Cross=No	An alarm from any initiating device activates the releasing zone.
Cross=Yes	An alarm from any two initiating devices activates the releasing zone.
Cross=Zone For example:	An alarm from two initiating devices mapped to different primary general zones, but mapped to the same releasing zone. <ul style="list-style-type: none"> <li>• An alarm from L02D101 and L02D103</li> <li>• An alarm from L02D102 and L02D104</li> <li>• An alarm from L02D101 and L02D104</li> <li>• An alarm from L02D102 and L02D103</li> </ul> The two detectors listed in each set above are each mapped to different primary general zones, but both list ZR01 in their zone maps.
Cross=Heat	Activation of heat detector L02D104 and one smoke detector (L02D101, L02D102, or L02D103).

### B.3.6 Using Type Codes for Releasing Zones

The control panel provides a set of Type Codes designed for releasing applications for inputs and outputs. This section details how to program each of these Type Codes.

Type Codes designed for releasing zone **inputs** (SLC monitor modules).

Type Code	What the Type Code does	Refer to
ABORT SWITCH (tracking)	Provides an abort function through a monitor module (connected to a UL-listed abort station) for a releasing zone.	"How to Program an Abort Switch" on page 118
MAN. RELEASE (latching)	Provides a manual release through a monitor module (connected to a UL-listed pull station) for a releasing zone.	"How to Program a Manual Release Switch" on page 119
MAN REL DELAY (latching)	Provides a manual release with a 10-second delay through a monitor module (connected to a UL-listed pull station) for a releasing zone.	"How to Program a Manual Release Delay Switch" on page 120
SECOND SHOT (latching)	Provides a second manual release through a monitor module (connected to a UL-listed pull station) for a releasing zone.	"How to Program a Second Shot Switch" on page 121

Type Codes designed for releasing zone **outputs** (SLC control modules).

Type Code	What the Type Code does	Refer to
REL END BELL	Activates an NAC audio or visual device when releasing circuits shut off.	"How to Program a Release End Bell Circuit" on page 122
REL CKT ULC	Directs outputs to perform a release function as required by ULC.	"How to Program a ULC Release Circuit" on page 123
RELEASE CKT	Directs outputs to perform a releasing function.	"How to Program a Release Circuit" on page 124
REL. FORM C	Directs relay outputs to perform a releasing function.	"How to Program a Release Form-C Circuit" on page 125
REL AUDIBLE	Activates audio or visual devices steady when releasing starts.	"How to Program a Release Audible Circuit" on page 126
INST RELEASE	Activates non-releasing output (SLC modules) with no delay time.	"How to Program an Instant Release Circuit" on page 127

## How to Program an Abort Switch

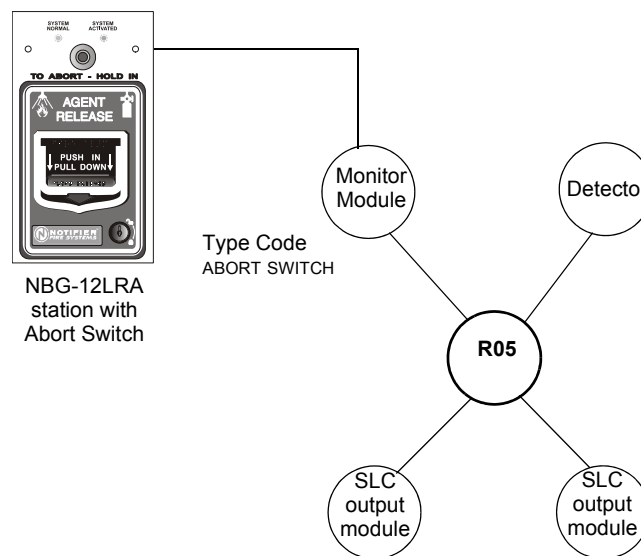
The following contains information needed to program an Abort Switch for a monitor module.

**Description** A monitor module, connected to a UL-listed abort station (such as the Notifier NBG-12LRA), used to monitor an abort switch for a releasing zone. Multiple monitor modules can be programmed with the ABORT SWITCH Type Code. They will work like multiple conventional abort switches on a conventional zone.

**Program** Select a monitor module for use as an Abort Switch. While programming this module (refer to Section 3.4.2, “Module Point”, on page 55 for instructions),

1. Select the ABORT SWITCH Type Code.
2. Enter the number of the desired releasing zone into the module’s zone map. The releasing zone must be fully programmed, with the Abort Switch type code included (refer to Section 3.4.4, “Releasing Zone”, on page 62).

**Example** A programming example of a monitor module programmed as an Abort Switch for Releasing Zone ZR05.



**Figure B.9 Monitor Module Configured as an Abort Switch**

## How to Program a Manual Release Switch

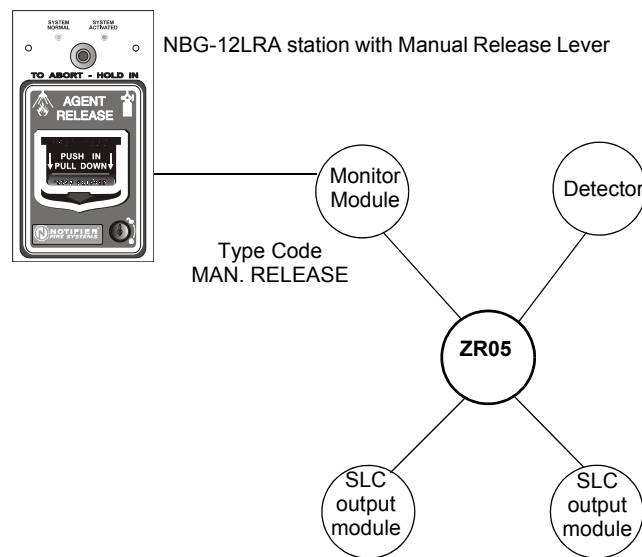
The following contains information needed to program a Manual Release switch for a monitor module.

**Description** A monitor module—connected to a UL-listed manual station (such as the Notifier NBG-12LRA)—used to monitor a pull station for the manual release of agents. A Manual Release switch overrides all timers, such as Delay Time or a Soak Time. Multiple monitor modules can be programmed with a MAN. RELEASE type code. They work like multiple conventional manual release switches on a conventional zone.

**Program** Select a monitor module for the manual release function. While programming this module (refer to Section 3.4.2, “Module Point”, on page 55 for instructions),

1. Select the MAN. RELEASE type code.
2. Enter the number of the desired releasing zone into the module’s zone map. The releasing zone must be fully programmed (refer to Section 3.4.4, “Releasing Zone”, on page 62).

**Example** A programming example of a monitor module programmed as an manual release switch for releasing zone ZR05.



**Figure B.10 Monitor Module Configured as a Manual Release Switch**

## How to Program a Manual Release Delay Switch

The following contains information needed to program a Manual Release Delay switch for a monitor module.

**Description** A monitor module—connected to a UL-listed manual station (such as the Notifier NBG-12LRA)—used to initiate a manual release with 10-second delay time.

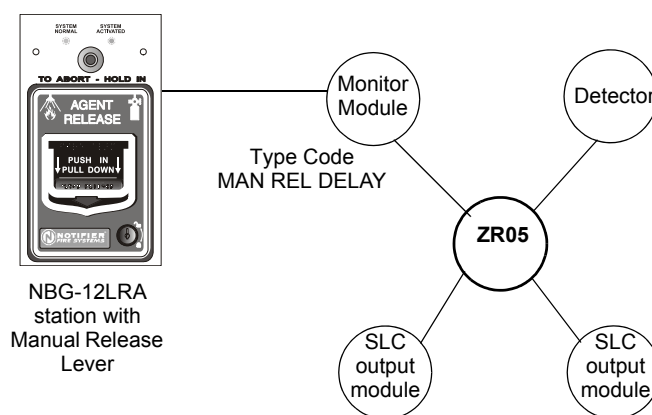
A Manual Release Delay switch overrides the FACP programmed Delay Time, but not Soak Time.

Multiple monitor modules can be programmed with a MAN REL DELAY type code. They work like multiple conventional manual release switches on a conventional zone.

**Program** Select a monitor module for the manual release function. While programming this module (refer to Section 3.4.2, “Module Point”, on page 55 for instructions),

1. Select the MAN REL DELAY type code.
2. Enter the number of the desired releasing zone into the module’s zone map. The releasing zone must be fully programmed (refer to Section 3.4.4, “Releasing Zone”, on page 62).

**Example** A programming example of a Monitor module programmed for MAN REL DELAY switch for Releasing Zone ZR05.



**Figure B.11 Monitor Module Configured as a Manual Release Delay Switch**

For example, program releasing zone ZR05 with a Manual Release Delay switch for the following releasing selections: Delay Time = 15, Abort Switch = ULI, Cross Zone = NO, Soak Time = 30.

When the Manual Release Delay Switch activates, the control panel replaces the remainder of the 15-second Delay Time, if running, with a 10-second timer.

### Examples:

1. The FACP programmed Delay Time begins its 15 second countdown. The Manual Release Delay switch is pulled when the FACP delay timer has counted down to 12 seconds. The 12 seconds remaining in the countdown are overridden by the 10-second delay initiated by the Manual Delay switch. In this example, the total time elapsing from FACP countdown initiation to agent release is 13 seconds, less than the original 15 second FACP Delay Timer countdown.
2. The FACP programmed Delay Time begins its 15 second countdown. The Manual Release Delay switch is pulled when the FACP Delay Timer has counted down to 8 seconds. The 8 seconds remaining in the countdown are overridden by the 10-second delay initiated by the Manual Delay switch. In this example, the total time elapsing from FACP countdown initiation to agent release is 17 seconds, more than the original 15 second FACP Delay Timer countdown.
3. The FACP programmed Delay Time is not running (as would happen if the releasing station were pulled before an alarm registered). The Manual Release Delay Switch is activated by the pull station. Agent release will occur in 10 seconds.



## How to Program a Second Shot Switch



**NOTE:** The Second Shot switch can only be used with the MAN REL DELAY Type Code.

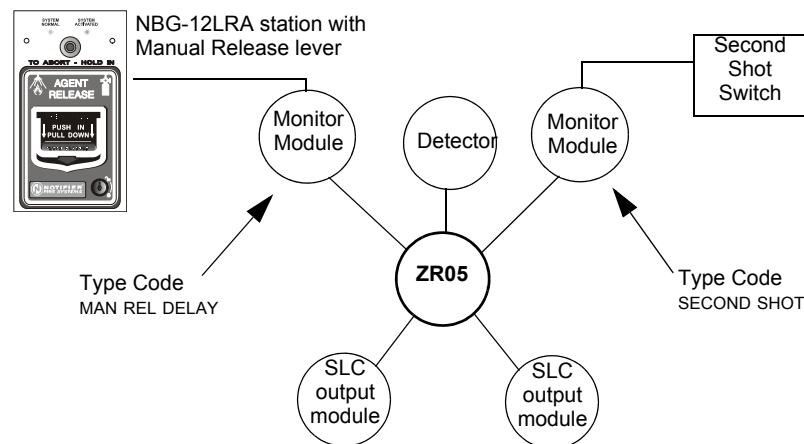
The following contains information needed to program a Second Shot switch for a monitor module

**Description** A monitor module—connected to a UL-listed manual station (such as the NBG-12LRA)—used as for a second release of agents. A Second Shot switch overrides a Delay Timer programmed to the same Releasing Zone.

**Program** Select a monitor module for the manual release function. While programming the module (refer to Section 3.4.2, “Module Point”, on page 55 for instructions)

1. Select the SECOND SHOT Type Code.
2. Enter the number of the desired releasing zone into the module’s zone map. The releasing zone must be fully programmed (refer to Section 3.4.4, “Releasing Zone”, on page 62).

**Example** A programming example of a monitor module programmed as a MAN REL DELAY switch for the first shot and a SECOND SHOT switch for the second shot.



**Figure B.12 Monitor Module Configured as a Second Shot Switch**

With two monitor modules configured as shown above, program releasing zone ZR05 for the following releasing selections:

Delay Time = 15, Abort Switch = ULI, Cross Zone = Y, Soak Time = 30

ZR05 can be activated in one of two ways, as described in the examples given below.

**Example 1:** If the detector initiates the alarm, ZR05 activates. Releasing begins after the delay timer has expired (15 seconds). Releasing will continue for the soak timer duration (30 seconds). The Second Shot switch can then be activated, and will remain activated for the soak timer duration. Once the soak timer expires, the Second Shot switch can then be activated to initiate an additional soak cycle.

**Example 2:** If the NBG-12LRA (Type Code MAN REL DELAY) lever is pulled, the manual release delay timer begins its 10 second countdown. Releasing will begin after the manual release delay timer has expired, and will continue for the soak timer duration (30 seconds). The Second Shot switch can then be activated, and will remain activated for the soak timer duration. Once the soak timer expires, the Second Shot switch can then be activated to initiate an additional soak cycle.

## How to Program a Release End Bell Circuit



**NOTE:** A releasing circuit with this Type Code requires the following selections: a Releasing Zone; an output circuit mapped to the same Releasing Zone; Switch Inhibit; Non-Silenceable; No Walk Test.

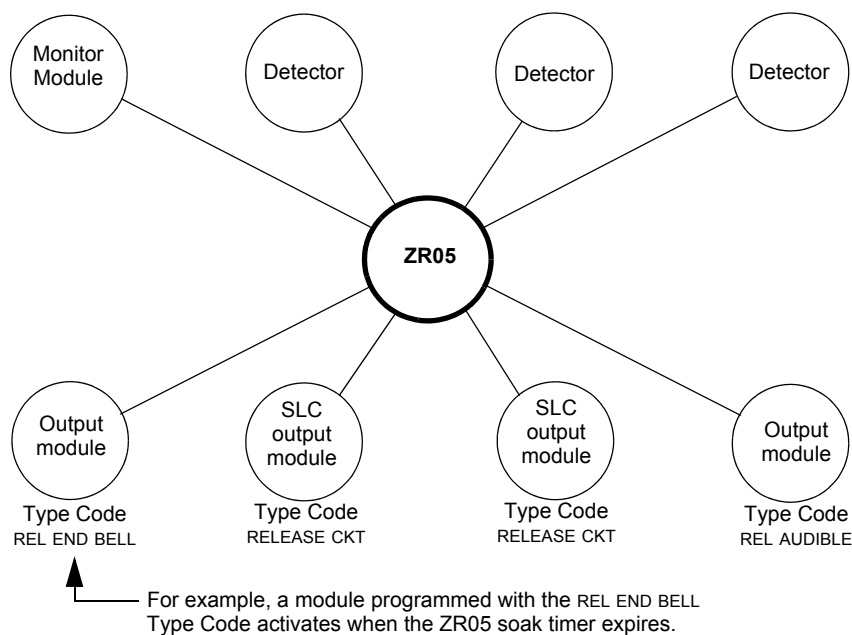
The following contains information needed to program a Release End Bell circuit for an SLC output module.

**Description** An SLC output module to activate an audible or visual device when releasing devices shut off when soak time is complete. Multiple outputs with the REL END BELL Type Code can be mapped to the same Releasing Zone. When the soak timer has expired, all outputs with the REL END BELL Type Code activate at the same time. A REL END BELL circuit remains on until the system is reset.

**Program** Select an SLC output module to use as a Release End Bell circuit. While programming the point (refer to the Point Programming section of this manual for instructions),

1. Select the REL END BELL Type Code,
2. Enter the number of the desired releasing zone into the module's zone map. The releasing zone must be fully programmed (refer to Section 3.4.2, "Module Point", on page 55).

**Example** A programming example of a control module programmed as a Release End Bell for Releasing Zone ZR05.



**Figure B.13 Output Module Configured as a Release End Bell Circuit**

## How to Program a ULC Release Circuit



**NOTE:** A ULC Release Circuit with this Type Code requires the following selections: a Releasing Zone; an output circuit mapped to the same Releasing Zone; Switch Inhibit; Non-Silenceable; No Walk Test.

The following contains information needed to program a ULC Release Circuit for an SLC output module.

**Description** An SLC output module used to activate a releasing solenoid or other releasing device. Multiple outputs with the REL CKT ULC Type Code can also be mapped to the same Releasing Zone. When the Releasing Zone activates, all outputs with the REL CKT ULC Type Code also activate at the same time. A ULC Release Circuit activates when:

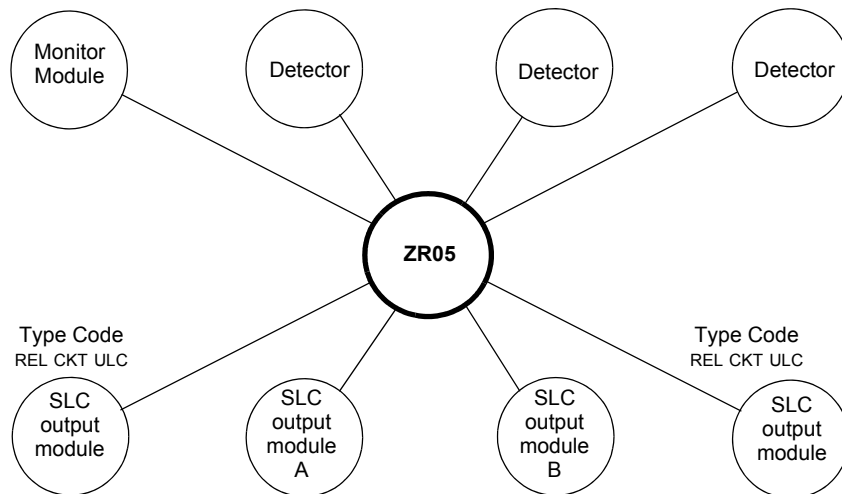
- An initiating device programmed to the same Releasing Zone activates (two devices if using the Cross Zone option)
- The Delay Timer for the Releasing Zone (if used) expires
- No Abort Switch for the Releasing Zone (if used) is active

A ULC Release Circuit—and all wiring to the release device—is fully supervised and usable with power-limited energy cable.

**Program** Select an SLC output module to use for a ULC Release Circuit. While programming the point (refer to the Point Programming section of this manual for instructions),

1. Select the REL CKT ULC Type Code,
2. Enter the number of the desired Releasing Zone into the module’s zone map. The releasing zone must be fully programmed (refer to Section 3.4.4, “Releasing Zone”, on page 62).

**Example** A programming example of a control module programmed as a ULC Release Circuit for Releasing Zone ZR05.



**Figure B.14 Output Module Configured as a ULC Release Circuit**

## How to Program a Release Circuit



**NOTE:** A Release Circuit with this Type Code requires the following selections: a Releasing Zone; an output circuit mapped to the same Releasing Zone; Switch Inhibit; Non-Silenceable; No Walk Test.



**NOTE:** Do not use a Release Circuit for the following: An application requiring ULC Listing; An application requiring power-limited energy cable.

The following contains information needed to program a Release Circuit for an SLC output circuit module.

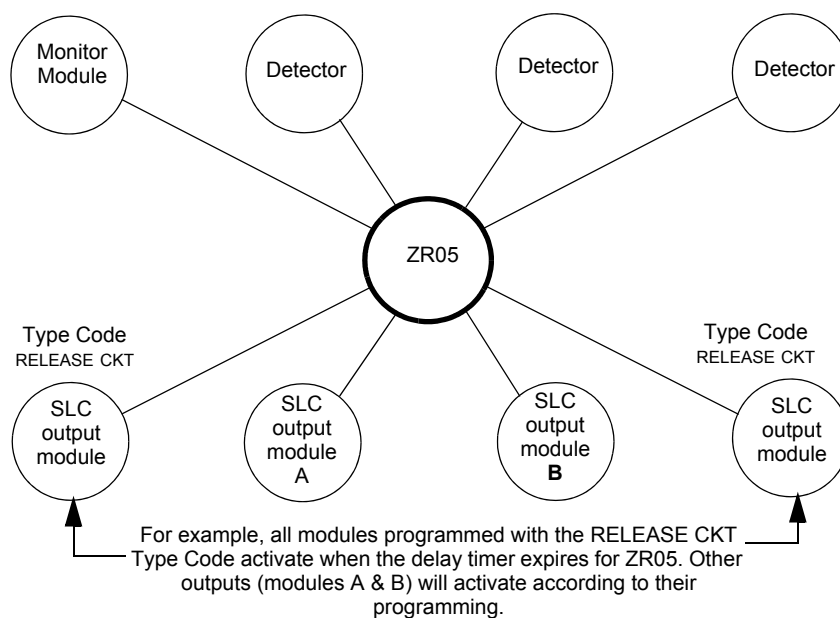
**Description** An SLC output module used to activate a releasing solenoid or other releasing device. Multiple outputs with the RELEASE CKT Type Code can be mapped to the same Releasing Zone. When the Releasing Zone activates, all outputs associated with the releasing zone and with the RELEASE CKT Type Code also activate at the same time. A Release Circuit activates when:

- An initiating device programmed to the same Releasing Zone activates (two devices if using the Cross Zone option)
- The Delay Timer for the releasing zone (if used) expires
- The Abort Switch for the releasing zone (if used) is not active

**Program** Select an SLC output module to use as a Release Circuit. While programming the point (refer to the Point Programming section of this manual for instructions),

1. Select the RELEASE CKT Type Code
2. Enter the number of the desired Releasing Zone into the module's zone map. The releasing zone must be fully programmed (refer to Section 3.4.4, "Releasing Zone", on page 62).

**Example** A programming example of a control module programmed as a Release Circuit for Releasing Zone ZR05.



**Figure B.15 Output Module Configured as a Release Circuit**

## How to Program a Release Form-C Circuit



**NOTE:** An output with a REL. FORM C Type Code requires the following selections: a Releasing Zone; an output circuit mapped to the same Releasing Zone; Switch Inhibit; Non-Silenceable; No Walk Test.

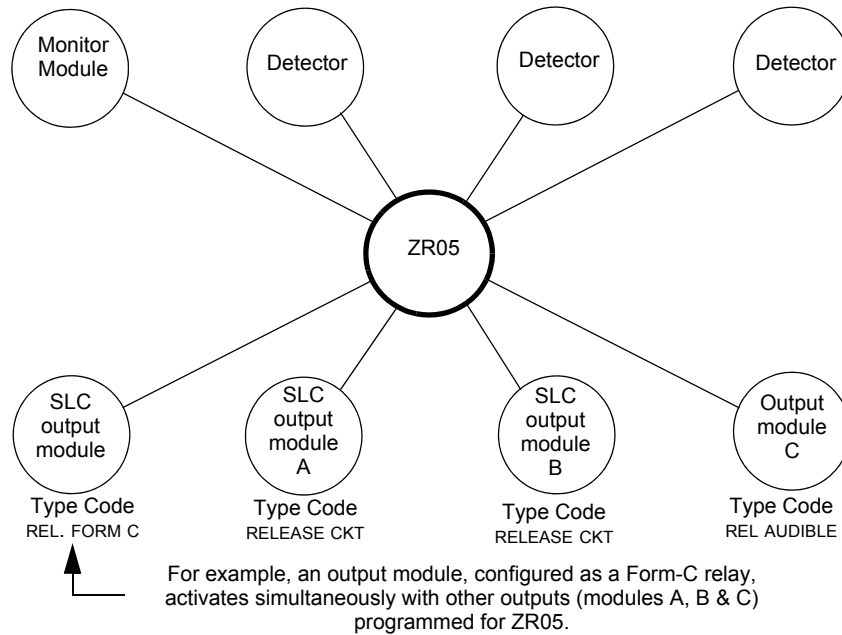
The following contains information needed to program a Release Form-C circuit for an SLC Form-C relay output module.

**Description** An SLC output module, configured as a relay, programmed to activate an output by opening or closing a switch. Typical applications include closing doors and air handlers.

**Program** Select an SLC output module to use as a Releasing Form-C Circuit. While programming the point (refer to the Point Programming section of this manual for instructions),

1. Select the REL. FORM C Type Code,
2. Enter the number of the desired Releasing Zone into the module's zone map. The releasing zone must be fully programmed (refer to Section 3.4.4, "Releasing Zone", on page 62).

**Example** A programming example of a control module programmed as a Release Form-C circuit for Releasing Zone ZR05.



**Figure B.16 Control Module Configured as a Release Form-C Circuit**

## How to Program a Release Audible Circuit



**NOTE:** An output with a REL AUDIBLE Type Code requires the following selections: a Releasing Zone; an output circuit mapped to the same Releasing Zone; Switch Inhibit.

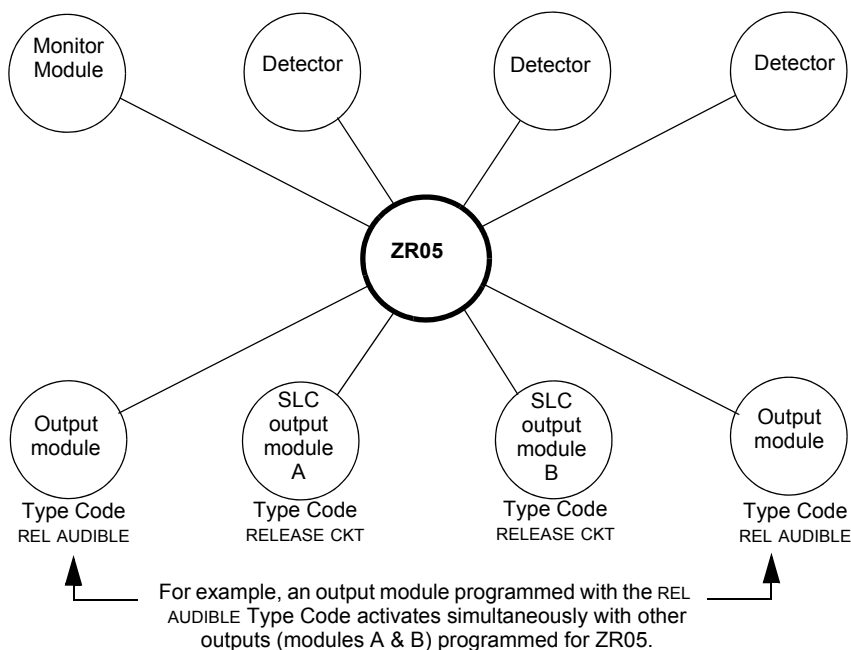
The following contains information needed to program a Release Audible circuit for an SLC output module.

**Description** An output module programmed to activate an audio or visual device when all releasing outputs, programmed to the same Releasing Zone, turn on. Multiple outputs with the REL AUDIBLE Type Code can be mapped to the same Releasing Zone. When the Releasing Zone activates, all outputs with the REL AUDIBLE Type Code activate at the same time.

**Program** Select a control module to use as a releasing circuit. While programming the point (refer to the Point Programming section of this manual for instructions),

1. Select the REL AUDIBLE Type Code,
2. Enter the number of the desired Releasing Zone into the module's zone map. The releasing zone must be fully programmed (refer to Section 3.4.4, "Releasing Zone", on page 62).

**Example** A programming example of a control module programmed as a Release Audible circuit for Releasing Zone ZR05.



**Figure B.17 Output Module Configured as a Release Audible Circuit**

## How to Program an Instant Release Circuit



**NOTE:** An output with an INST RELEASE Type Code requires the following selections: a zone selection (a releasing zone may be used, but is not required); an output circuit mapped to the same zone; Switch Inhibit; Non-Silenceable; No Walk Test.

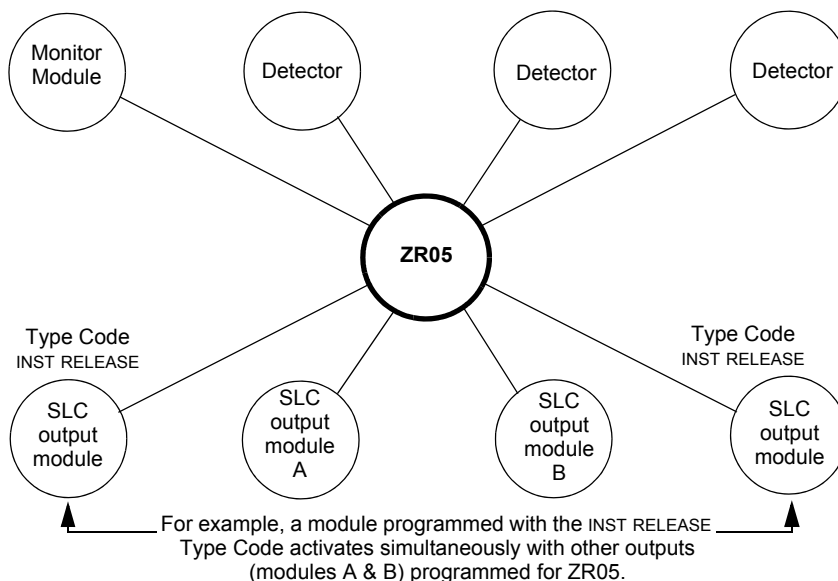
The following contains information needed to program an Instant Release circuit for an SLC output module.

**Description** An SLC output circuit module programmed to activate non-releasing devices, such as door openers or warning sounders, without counting down delay timers. A device programmed with the INST RELEASE Type Code device is supervised for open circuits and ground faults.

**Program** Select an SLC output module to use with a releasing circuit. While programming the point (refer to the Point Programming section of this manual for instructions),

1. Select the INST RELEASE Type Code,
2. Enter the number of the desired Releasing Zone into the module's zone map. The releasing zone must be fully programmed (refer to Section 3.4.4, "Releasing Zone", on page 62).

**Example** A programming example of a control module programmed as an Instant Release circuit for Releasing Zone ZR05.



**Figure B.18 Output Module Configured as an Instant Release Circuit**

## How to Program a Release Code Bell Circuit

When coded output is desired to indicate different phases of a releasing operation, the panel can be programmed using Control-By-Event (CBE) to turn on outputs set to provide the chosen codes.

**Example Description** In the following example, programming is shown that will

1. Turn on an output when the first alarm activates in a releasing zone, but Cross Zone conditions are not met. Turn it off when the Delay Timer starts.
2. Turn on a different output when Cross Zone conditions are met and the Delay Timer activates, and turn it off when releasing starts.
3. Turn on a different output when releasing starts, and turn it off when the soak timer expires or the system is reset.

The outputs are each set to a code appropriate for one of the three releasing phases: for example, one code for the first alarm, a faster code when the Delay Timer activates, and a continuous tone during releasing.

**Program** Program releasing zone ZR1 as follows:

ZR1 = Delay Time:15, Abort Switch:ULI, Cross Zone:YES, Soak Time:120

Map ZR1 to all inputs and outputs shown in this example.

Program logic zones as follows:

ZL1 = AND(OR(L1D1,L1D2,L1D3,L1D4,L1D5,L1D6),NOT(L1M30))

When conditions are met for ZL1, a first alarm has occurred in the releasing zone, but the Delay Timer has not yet started. Map ZL1 to an output set to the code chosen for a first alarm (L1M31 in this example).

ZL2 = AND(L1M30,NOT(L1M20))

When conditions are met for ZL2, the Delay Timer has started, but releasing has not begun. Map ZL2 to the output set to the code chosen for when the Delay Timer activates (L1M32 in this example).

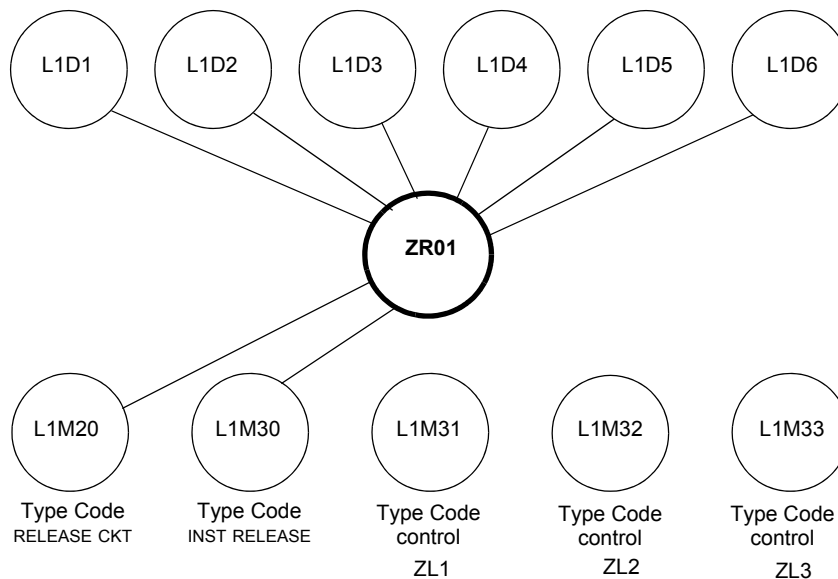
ZL3 = OR(L1M20)

When conditions are met for ZL3, the 120 second releasing operation has begun. Map ZL3 to the output that produces a continuous tone (L1M33 in this example).

Program output Type Codes as follows:

L1M20 = RELEASE CKT, L1M30 = INST RELEASE, L1M31 = CONTROL, L1M32 = CONTROL, L1M33 = CONTROL

### Illustration



**Figure B.19 A Release Code Bell Circuit Configuration**

## B.4 Miscellaneous

### B.4.1 Initiating Devices

Releasing zone initiating devices include the following:

- FST-851/751 intelligent heat detectors
- FSI-851/751, FSP-851/751, FAPT-851/751, FSL-751 intelligent smoke detectors
- Conventional detection UL-listed devices connected to monitor modules



Multiple zone initiating devices can be used for the same releasing hazard. Map zone initiating devices to the same Releasing Zone. Factory Mutual and certain Local Authorities Having Jurisdiction require using redundant wiring (NFPA 72 Style 6 or Style D) for initiating devices in releasing applications.

## B.4.2 Warning Sounders

Warning sounders connect to SLC output module circuits (refer to this panel's installation manual). Note the following:

- If selecting Cross Zones, a warning sounder only activates when two zones alarm.
- Warning sounders, unlike release solenoids, do not wait for a Delay Timer.
- If Coding Functions are required for warning sounders, use an SLC output module.
- The same releasing hazard can activate multiple NACs.

Instructions for activating warning sounders:

To activate a sounder	Do this
When the Delay Timer starts, when the releasing device activates, or both	Map the SLC to a releasing hazard zone (R0-R9).
Immediately when one of the initiating devices activate	Map the SLC output to a separate zone (not R0-R9) that is also mapped to all initiating devices of the hazard.

## B.4.3 Auxiliary Control Functions

Instructions for using control functions:

Function	Do this
A releasing application requires control relays	Use control modules set for dry contact operation. Program the control relays for different functions by following the instructions in "To activate a sounder" above.
Providing control functions	Use an ACM-8R remote relay module mapped to the software zones of the control panel.

## B.4.4 ACS Annunciation

Releasing points may be mapped to annunciators using annunciator point programming (Refer to "ACS Point Programming" on page 34).

# Appendix C: Special Zone Outputs

## C.1 Presignal and Positive Alarm Sequence (PAS)

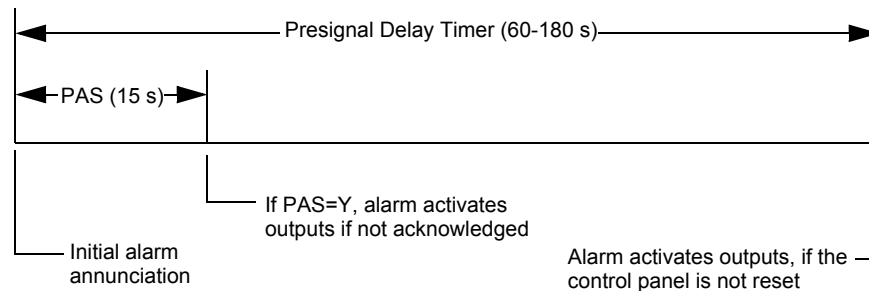
### C.1.1 What is Presignal and PAS?

#### Purpose

Presignal is a feature that initially causes alarm signals to only sound in specific areas, monitored by qualified persons. This allows delay of the alarm up to 180 seconds after the start of alarm processing. The control panel Presignal feature provides two selections:

- A **Presignal Delay Timer** (1:00 to 3:00 minutes) that delays activation of all outputs with a CBE that includes Special Zone ZF0.
- A **PAS** (Positive Alarm Sequence) selection, in addition to the Presignal Delay Timer, that allows a 15-second time period for acknowledging an alarm signal from a fire detection/initiating device. If the alarm is not acknowledged within 15 seconds, all local and remote outputs activate immediately and automatically.

An illustration of Presignal and PAS timing.



**Figure C.1 Presignal and PAS Time**

The control panel delays activation of outputs containing ZF0 in their zone maps for all alarm initiating devices that contain ZF0 in their CBE list. A subsequent alarm will abort the Presignal Delay Timer and execute CBE lists.

#### Notes on using ZF0

- NFPA 72 requires installation of a PAS Inhibit switch, that can be used to turn off the PAS delay timer when the control panel is unattended. Do so by programming a monitor module with the Type Code, PAS INHIBIT.
- The Presignal Delay timer countdown can be stopped by pressing the SYSTEM RESET key before the timer expires.
- Program zone ZF0 to participating inputs and outputs.

#### Restrictions on using ZF0

- Do not include ZF0 in the CBE list for a releasing device.
- Do not include ZF0 in the CBE list for any monitor module that connects to a device other than an automatic fire detector.

### C.1.2 Selecting Presignal and PAS Outputs

#### Presignal

The Presignal Delay Timer can be set to a value between 60 and 180 seconds. A Presignal Delay Timer does not apply to the following:

- System Alarm relay

- TM-4 polarity reversal alarm output
- TM-4 municipal box output
- UDACT/UDACT-2

### Positive Alarm Sequence (PAS)

Outputs selected for PAS delay for 15 seconds. Acknowledgement within the 15-second delay will set the Presignal Delay Timer to the full programmed value (60-180 seconds, including the PAS delay of 15 seconds). When an alarm comes from an initiating device with a CBE list that includes ZF0, the control panel delays the following outputs:

- System Alarm relay
- TM-4 polarity reversal alarm output
- TM-4 municipal box output
- UDACT/UDACT-2

## C.2 Drill Mode

### C.2.1 What is Drill Mode?

Drill Mode is a feature that customizes drill activations, allowing only specific devices on the NFS2-3030 to activate when a local or network Drill is performed. These devices require the drill zone (Special Function Zone 16) to be added to the zone mapping of each point. Refer to “Point Program” on page 46.

There are two options for Drill Mode Programming:

- **Standard** - The fire panel will turn on all appropriate output devices.
- **Custom** - The fire panel will turn on all output devices with zone mapping that includes Special Function Zone 16.

#### When in Standard Drill Mode:

- The Drill Zone does not activate.
- Performing a Signal Silence will turn off all silenceable outputs.
- Activation of another drill will return all silenceable outputs to an active state.
- All silenceable and non-silenceable outputs will turn off following a System Reset.

#### When in Custom Drill Mode:

- Performing a Signal Silence will turn off all silenceable outputs.
- Activation of second drill will not return the silenceable outputs to an active state unless a System Reset is performed.
- All silenceable and non-silenceable outputs will turn off following a System Reset.
- The Drill Zone will remain active until a System Reset is performed to clear the Drill Condition.

The Drill Zone will activate when a drill is initiated from the fire panel keypad, ACS, a module set as a drill switch, or via the network.

## C.3 Mass Notification

When used for mass notification, special zones ZF20, ZF21, and ZF22 can be used to signal the MN events.



---

**NOTE:** During local or network Walk Test, activating a Mass Notification device will activate associated special function zones according to CBE programming and simulate a Mass Notification event. Any network nodes, zones, or devices not participating in Walk Test will not participate in the simulated Mass Notification event.

---

### ZF20 - MN Alarm

When an MN Alarm condition exists on the fire panel:

- ZF20 will activate and any CBE activations will be initiated.
- ZF20 activation is sent over the network.
- The OTHER LED will flash. (on steady after Acknowledged)
- The piezo will sound a steady audible tone. (silent after Acknowledged)
- Any devices programmed as General Pending will activate.
- Any alarm relays or devices programmed as General Alarm or Alarm Pending type codes do not activate.
- Any devices programmed as “Resound by Fire” will not activate.
- If the fire panel is programmed so that MN events have priority over fire events, and a fire condition exists on the fire panel, any fire activation(s) will be suppressed locally as well as for any network nodes that MN mapped to the panel via VeriFire Tools.
- The MN Alarm message will not be sent to the proprietary receiver via the network.
- If the ZF20 activation is received from the network and the fire panel is All Systems Normal, “NETWORK MN ACTIVE” is displayed on the status bar of the fire panel.

### ZF21 - MN Supervisory

When an MN Supervisory condition exists on the fire panel:

- ZF21 will activate and any CBE activations will be initiated.
- ZF21 activation is sent over the network.
- The SUPERVISORY LED will flash. (on steady after Acknowledged)
- The piezo will sound a warbling audible tone. (silent after Acknowledged)
- Any devices programmed as General Pending will activate.
- Any devices programmed as General Supervisory will not activate.
- Any devices programmed as “Resound by Supervisory” will not activate.
- The fire panel’s Supervisory relay will not activate.
- The MN Supervisory message is sent to the proprietary receiver via the network.
- If the fire panel is programmed so that MN events have priority over fire events, and a fire condition exists on the fire panel, an MN Supervisory will not suppress any fire alarms locally or for any network nodes that MN mapped to the panel via VeriFire Tools.

### ZF22 - MN Trouble

When an MN trouble condition exists on the fire panel:

- ZF22 will activate and any CBE activations will be initiated.
- ZF22 activation is sent over the network.
- The TROUBLE LED will flash. (on steady after Acknowledged)
- The piezo will sound a pulsed audible tone. (silent after Acknowledged)

- Any devices programmed as General Pending, Trouble Pending and General Trouble will activate.
- Any devices programmed as “Resound by Trouble” will not resound.
- The fire panel’s Trouble relay will activate.
- The MN Trouble message is sent to the proprietary receiver via the network.
- If the fire panel is programmed so that MN events have priority over fire events, and a fire condition exists on the fire panel, an MN Trouble will not suppress any fire alarms locally or for any network nodes that MN mapped to the panel via VeriFire Tools.

# Appendix D: Intelligent Sensing Applications

## D.1 Intelligent Sensing Overview

Intelligent Sensing is a set of software algorithms that provide the NFS2-3030 with industry-leading smoke detection capability. The user can program Intelligent Sensing functions on a global or on a per-detector basis.

Intelligent Sensing topics covered in this appendix:

Topic	Page
<b>Intelligent Sensing features</b> – Descriptions of Intelligent Sensing features, such as Drift Compensation, Sensitivity Adjust, programmable on a per-detector basis.	134
<b>Pre-Alarm</b> – Alert and Action settings, programming (global settings).	137
<b>Detector Sensitivity Settings</b> – Pre-Alarm and Alarm sensitivity settings for photo, ion, laser, and multisensor detectors programmable on a per-detector basis.	138
<b>Detector Maintenance Features</b> – Instructions for viewing and printing detector maintenance information.	140

## D.2 Intelligent Sensing Features

Intelligent Sensing features include the following:

- Drift Compensation and Smoothing
- Maintenance Warnings - Three Levels
- Self-optimizing Pre-Alarm
- Detector Sensitivity
- Cooperative Multi-Detector Sensing

### D.2.1 Drift Compensation and Smoothing

Drift compensation uses algorithms (U.S. patent pending) that identify and compensate for long-term changes in the analog readings from each smoke detector. (Typically, dirt and dust accumulation inside the smoke chamber causes long-term changes in detector readings.) Drift compensation does the following:

- Allows a detector to retain its original ability to detect actual smoke, and resist false alarms, even as dirt and dust accumulates.
- Reduces maintenance requirements by allowing the control panel to automatically perform the periodic sensitivity measurements required by NFPA Standard 72.

The software also provides smoothing filters to remove transient noise signals, usually caused by electrical interference. Different smoothing algorithms are used, depending on the sensitivity selection of each detector. Refer to Appendix D.4, “Detector Sensitivity Settings”, on page 138 for more information on detector sensitivity levels.

A graphic representation of a detector analog reading using drift compensation and smoothing:

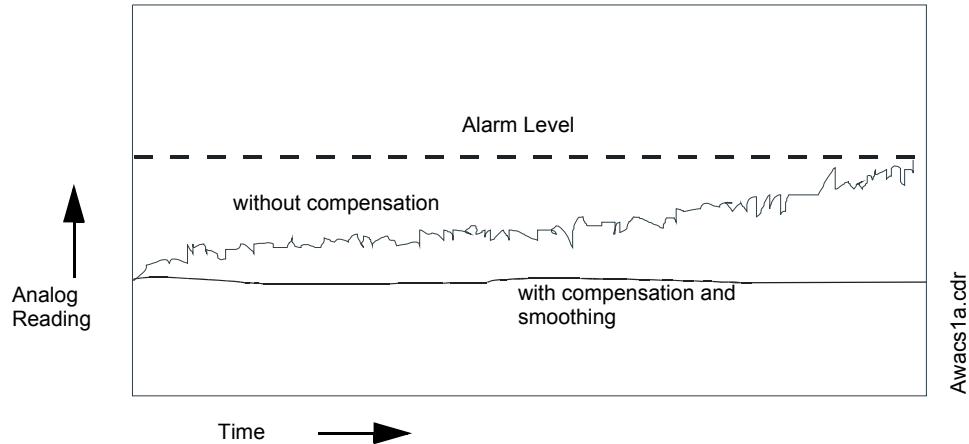


Figure D.1 Graphic Representation of Drift Compensation

### D.2.2 Maintenance Warnings – Three Levels

The software determines when the drift compensation for a detector reaches an unacceptable level that can compromise detector performance. When a detector reaches an unacceptable level, the control panel indicates a maintenance warning. The table below summarizes the three levels of Intelligent Sensing maintenance warnings:

Detector Trouble Message	Indicates	Detector Compensation Percentage Range		
		Ion	Photo or Photo with Heat	Laser
N/A	Compensation is within acceptable range.	6 - 80	6 - 45	3 - 50
LOW THRESHOLD	A hardware problem in the detector.	0 - 5	0 - 5	0 - 2
MAINTENANCE REQ	Dust accumulation that is near but below the allowed limit. The Maintenance Required is an alert level that indicates the need for maintenance before the performance of the detector is compromised.	92 - 99	92 - 99	83 - 99
MAINT.URGENT	Dust accumulation above the allowed limit.	100	100	100

Table D.1 Definitions of Intelligent Sensing Maintenance Levels

A graphic representation of the maintenance levels:

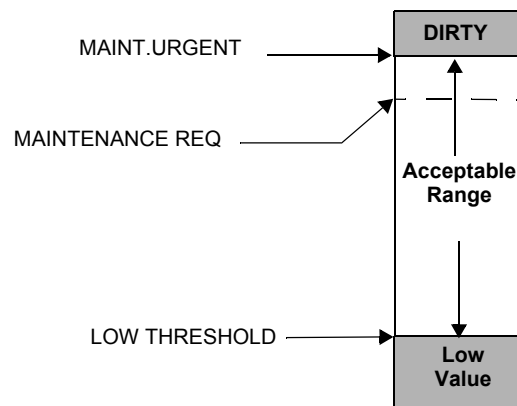


Figure D.2 Diagram of Maintenance Levels

### D.2.3 Self-Optimizing Pre-Alarm

You can set each detector, except FST-851/751 (Heat), for Self-Optimizing Pre-Alarm (PA=1). In this Self-Optimizing mode, the software measures the normal peak analog readings and sets the Pre-Alarm level just above these normal peaks. This allows extremely sensitive Pre-Alarm capability with reasonable protection against non-fire signals. The figure below shows a graphical representation of the Self-Optimizing Pre-Alarm level:

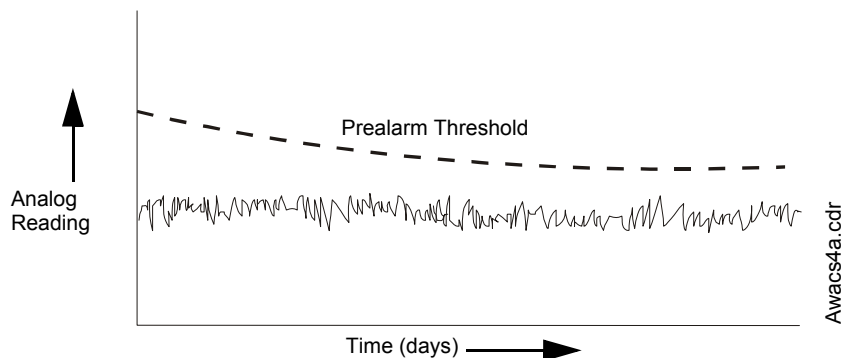


Figure D.3 Self-optimizing Pre-Alarm Level

### D.2.4 Detector Sensitivity

The control panel provides nine Sensitivity Levels (Table D.2 on page 138) for alarm detection and pre-alarm as follows:

- **Alarm Sensitivity Levels** You can select the sensitivity of a detector from 1-9 (1=highest sensitivity; 9=lowest sensitivity).
- **Pre-Alarm Sensitivity Levels** You can select one of nine levels from 1 to 9 (0=no Pre-Alarm, 1=self-optimizing, 2=highest sensitivity, 9=lowest sensitivity). You can set Pre-Alarm operation to Action (latching) or Alert (non-latching) and to activate Special Zones. For instructions on programming, refer to Appendix D.3, “Pre-Alarm”, on page 137.

You can set the sensitivity levels as fixed or programmed for day and night operation.

A sample sensitivity window for a laser detector:

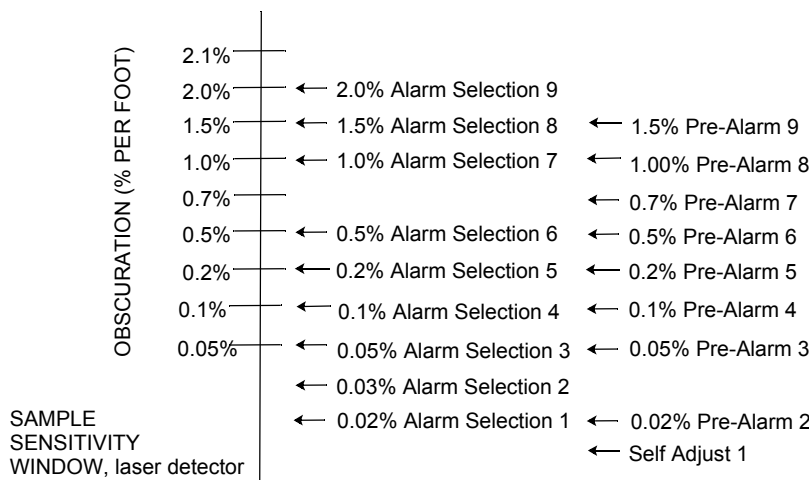


Figure D.4 Sample Sensitivity Levels for a FlashScan View Laser Detector



## D.2.5 Cooperative Multi-Detector Sensing

Cooperative Multi-Detector Sensing is the ability of a smoke detector to consider readings from nearby detectors in making alarm or pre-alarm decisions. Each detector can include up to two other detectors in its decision. Without statistical sacrifice in the ability to resist false alarms, Cooperative Multi-Detector Sensing allows a detector to increase its sensitivity to actual smoke by a factor of almost 2 to 1. Ion, photo and laser detector types can participate. Cooperative Multi-Detector Sensing also allows the combination of ionization with photoelectric technology in reaching an alarm decision. The figure below shows a graph representing Cooperative Multi-Detector Sensing:

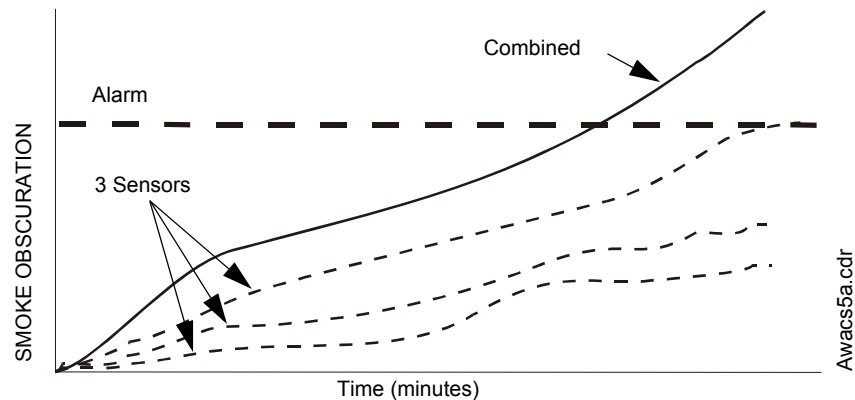


Figure D.5 Cooperative Multi-Detector Sensing

## D.3 Pre-Alarm

### D.3.1 Definition

The Pre-Alarm function is a programmable option which determines the system's response to real-time detector sensing values above the programmed setting. Use the Pre-Alarm function to get an early warning of incipient or potential fire conditions. There are two levels of Pre-Alarm:

- Alert (Refer to "Alert Level" below)
- Action (Refer to Appendix D.3.3, "Action Level", on page 138)

Alert and Action Pre-Alarm settings are set with point programming. Unique Pre-Alarm sensitivity levels (PA) for individual detectors are listed in Appendix D.4, "Detector Sensitivity Settings", on page 138.

The LEDs on detectors polled in FlashScan mode will light steady green when in pre-alarm.

### D.3.2 Alert Level

#### Alert Functions

The control panel software, in addition to checking for alarm levels, checks for Pre-Alarm thresholds for each addressable, intelligent smoke detector programmed for Pre-Alarm. If a detector's real-time sensing level exceeds the programmed Alert threshold, the control panel indicates a Pre-Alarm condition for the detector. The control panel does the following functions when a detector reaches pre-alarm level:

- The Pre-Alarm message is sent to the History buffer and to installed printers. The message is sent (and time stamped) at the time that it first occurred. This historical data could provide valuable information about the progress of a fire.
- The PRE-ALARM LED flashes and the panel sounder pulses until acknowledged.
- Zone Z000 (general alarm) or any other zone and the System Trouble and System Alarm relays do not activate.

- The Pre-Alarm indication for this detector will restore automatically to normal if its obscuration reading drops below pre-alarm level.
- A subsequent alarm for this detector also clears the Pre-Alarm indication.

### D.3.3 Action Level

#### Action Functions

If you program a detector for Action Pre-Alarm and the detector reaches a level that exceeds the programmed Pre-Alarm level, the control panel indicates an Action condition. The control panel does the following functions when a detector reaches the programmed pre-alarm level:

- The Action message is sent to the History buffer and installed printers. The message is sent (and time stamped) only at the time that it first occurred. This historical data could provide valuable information about the progress of a fire.
- The PRE-ALARM LED and panel sounder pulse until acknowledged.
- The zone that is in the tenth position of the zone map for this detector activates. The tenth zone is the right-most entry on line two of the detector zone map list in the Point Programming screen. (For more information on detector zone positions, refer to Figure 3.36 and the accompanying text). The tenth zone can be used to control functions of a detector or group of detectors once the pre-alarm level is reached. Tenth zone activations also allow ACS annunciation by a detector or group of detectors in Action Pre-Alarm condition.
- Zone Z000 (general alarm) or any other zone and the System Trouble and System Alarm relays do not activate.
- The Pre-Alarm condition and the zone programmed will latch until system reset, even if the obscuration reading drops below the pre-alarm level.
- A subsequent alarm condition for this detector clears the Action indication from the LCD display alarm list.

## D.4 Detector Sensitivity Settings

### D.4.1 How to Select Pre-Alarm and Alarm Sensitivity

Each detector provides a host of selectable intelligent options. The control panel provides nine levels of Pre-Alarm (PA:1–PA:9) and Alarm (AL:1–AL:9) in percent per foot obscuration:

- **PA:0** no Pre-Alarm selection.
- **PA:1** the self-optimizing setting where the control panel selects a suitable Pre-Alarm level for a detector.
- **PA:2–PA:9** the detector Pre-Alarm sensitivity level - with PA:2 the most sensitive and PA:9 the least sensitive.
- **AL:1–AL:9** the detector Alarm sensitivity level - with AL:1 the most sensitive and AL:9 the least sensitive.

Detector Type	Alarm (FlashScan)	Pre-Alarm
Photo Electric SMOKE (PHOTO) (See note *)	AL:1=0.50 %	PA:1=Auto
	AL:2=0.73 %	PA:2=0.30 %
	AL:3=0.96 %	PA:3=0.47 %
	AL:4=1.19 %	PA:4=0.64 %
	AL:5=1.43 %	PA:5=0.81 %
	AL:6=1.66 %	PA:6=0.99 %
	AL:7=1.89 %	PA:7=1.16 %
	AL:8=2.12 %~	PA:8=1.33 %~
	AL:9=2.35 %	PA:9=1.50 %

Table D.2 Detector Sensitivity Settings (1 of 2)

Detector Type	Alarm (FlashScan)	Pre-Alarm	
Ion SMOKE (ION) (See notes *, **, and †)	AL:1=0.50 % AL:2=0.75 % AL:3=1.00 % AL:4=1.25 % AL:5=1.50 % AL:6=1.75 %~ AL:7=2.00 % AL:8=2.25 % AL:9=2.50 %	PA:1=Auto PA:2=0.40 % PA:3=0.50 % PA:4=0.75 % PA:5=1.00 % PA:6=1.25 %~ PA:7=1.50 % PA:8=1.75 % PA:9=2.00 %	
FlashScan Laser‡ (See Note **)	AL:1=0.02 % AL:2=0.03 % AL:3=0.05 % AL:4=0.10 % AL:5=0.20 % AL:6=0.50 %~ AL:7=1.00 % AL:8=1.50 % AL:9=2.00 %	PA:1=Auto PA:2=0.02 % PA:3=0.05 % PA:4=0.10 % PA:5=0.20 % PA:6=0.50 %~ PA:7=0.70 % PA:8=1.00 % PA:9=1.50 %	
Acclimate Multi-Sensor See Note ††)	AL:1=0.50 % AL:2=1.00 % AL:3=1.00 to 2.00 % AL:4=2.00 % AL:5=2.00 to 3.00 %~ AL:6=3.00 % AL:7=3.00 to 4.00 % AL:8=4.00 % AL:9=thermal 135°F	Alarm (CLIP) AL:1=1.00 % AL:2=1.00 % AL:3=1.00 to 2.00 % AL:4=2.00 % AL:5=2.00 to 4.00 %~ AL:6=2.00 to 4.00 % AL:7=2.00 to 4.00 % AL:8=4.00 % AL:9=4.00 %	PA:1=0.50 % PA:2=1.00 % PA:3=1.00 % PA:4=1.00 to 2.00 % PA:5=1.00 to 2.00 %~ PA:6=2.00 % PA:7=2.00 % PA:8=2.00 to 3.00 % PA:9=2.00 to 3.00 %
Heat (Adjustable Threshold)	AL:1=43 °C AL:2=57 °C AL:3=63 °C~ AL:4=68 °C AL:5=74 °C AL:6=88 °C AL:7=88 °C AL:8=88 °C AL:9=88 °C	PA:1=40 °C PA:2=43 °C PA:3=57 °C~ PA:4=65 °C PA:5=70 °C PA:6=75 °C PA:7=75 °C PA:8=75 °C PA:9=75 °C	
Beam (See Note ††)	AL:1=25% AL:2=30% AL:3=40% AL:4=50% AL:5=30 - 50% AL:6=40 - 50%	PA:1=50% PA:2=55% PA:3=60% PA:4=65% PA:5=70% PA:6=75% PA:7=80% PA:8=85% PA:9=90%	
Intelliquad FSC-851 (See Note ***)	AL:1= 1% AL:2= 2% AL:3= 3% AL:4= 3% w/ 10 minute confirmation period**** AL:5= 4% w/ 10 minute confirmation period AL:6= Thermal 135°F	PA:1= 1% PA:2= 2% PA:3= 3% PA:4= 3% w/ 10 minute confirmation period PA:5= 4% w/ 10 minute confirmation period PA:6= Thermal 135°F	
Photo/CO	AL:1=1% AL:2=2% AL:3=3% AL:4=3% with a 10 minute confirmation period**** AL:5=4% with a 10 minute confirmation period AL:6=Thermal 135°F	PA:1=1% PA:2=2% PA:3=3% PA:4=3% with a 10 minute confirmation period PA:5=4% with a 10 minute confirmation period PA:6=Thermal 135°F	

~Signifies the factory default setting.

**Table D.2 Detector Sensitivity Settings (2 of 2)**

- \* Detectors are suitable for open area protection within the listed air velocity range. Typically, this range is 0 - 4,000 ft/min for photoelectric detectors and 0 - 1,200 ft/min for ionization detectors. Be sure to confirm this range before installing the detector by referring to the manufacturer's installation instructions.
- † For ION detectors installed in Canada: Use only an alarm sensitivity setting of AL=1, AL=2 or AL=3.
- ‡ 1% max. on CLIP. Larger figures may display.
- \*\* The use of alarm sensitivities below 0.50% obscuration per foot requires a 90 day test to ensure that the environment for the detectors is suitable for the higher sensitivity setting. (Refer to "To Test Detectors Set Below 0.50% Obscuration per Foot" on page 140.)
- †† For Acclimate detectors installed in Canada: Use only the alarm settings of AL:1 or AL:2.
- ‡‡ Refer to the beam detector manual to determine the alarm settings: they are a function of the distance between the detector and its reflector. There is no Prealarm for beam detectors in CLIP mode.
- \*\*\* AL:6 and PA:6 are not available in CLIP mode.
- \*\*\*\* Within the 10 minute signature confirmation delay period, if there is a detection of another fire signature (Carbon Monoxide, Infrared or Thermal) it overrides the 10 minute confirmation time.

## D.4.2 To Test Detectors Set Below 0.50% Obscuration per Foot

Using alarm sensitivities below 0.50% obscuration per foot requires a 90-day test to ensure that the detector environment is suitable for the higher sensitivity setting. To meet Notifier and Underwriters Laboratory requirements, test each detector planned to operate below 0.50%/ft obscuration as follows:

1. Set the detector as follows:

Step	Action
1	Initially set to the 0.50% obscuration per foot Alarm level.
2	Set the Pre-Alarm level to the desired final Alarm sensitivity.
3	Set the Pre-Alarm to Alert mode (non-latching).

2. Operate detectors continuously for 90 days with all environmental factors (such as, temperature, humidity, air flow, occupancy, and so on) similar to the intended application for the detectors. Record all events for each tested detector with an electronic History buffer or a printout.
3. At the end of the 90-day test: An authorized Notifier representative, or an end user trained by an authorized Notifier representative must inspect the results of the test. If the test results show no alarms or pre-alarms for the tested detectors, reprogram the fire alarm system to set the Alarm sensitivity to the more sensitive Pre-Alarm level of the test.

## D.5 Detector Status Display

### D.5.1 Detector Maintenance Display

Should the panel detect a low chamber value or maintenance condition with a detector, it will generate a point trouble as described in the operations manual for this panel. The following Read Status screen displays detector information that applies to the state of the smoke detector. It can be reached with the following commands, starting at the Main Menu screen:

- Press MAIN MENU
- Press READ STATUS
- Press READ STATUS POINT SELECT (enter the detector point address)

- Press ACCEPT

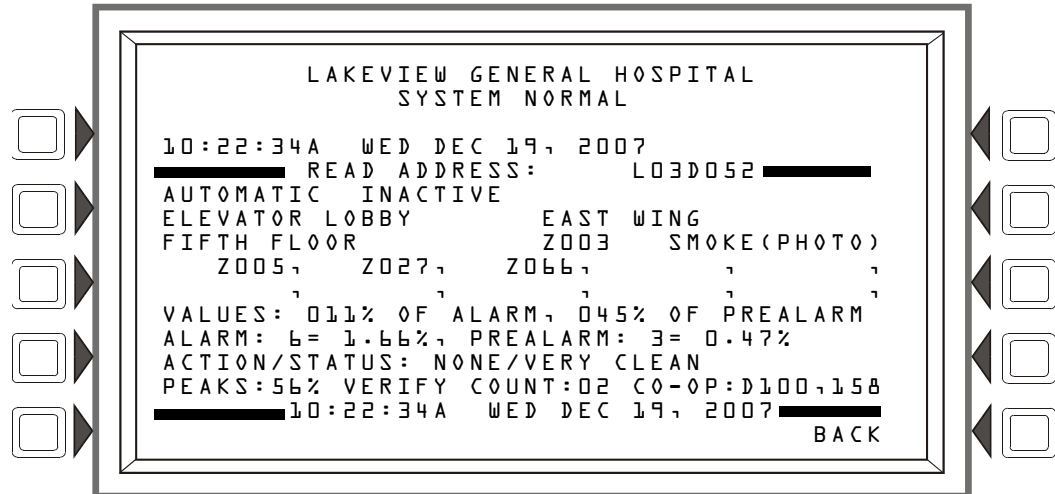


Figure D.6 Smoke Detector Screen - Read Status

### D.5.2 Print a Detector Maintenance Report

A Detector Maintenance Report lists detector maintenance status for each installed addressable detector [except FDX (an analog heat detector)].

To print this report, press the Printer Function soft key at the Main Menu, then press the Detector Maintenance Report soft key sends a Detector Maintenance Report (Figure D.7) to the printer connected to the control panel.

```

*****DETECTOR MAINTENANCE*****
NORMAL SMOKE(LASER) Detector L01D001 000330us 000340us Comp:000% Pk: 002%
Alarm: 000% PreAlarm: 000% A6P6 V000 L01D001

NORMAL SMOKE ACCLIM Detector L01D002 000030us 000000us Comp:000% Pk: 000%
Alarm: 000% PreAlarm: 000% A8P8 V000 L01D002
    
```

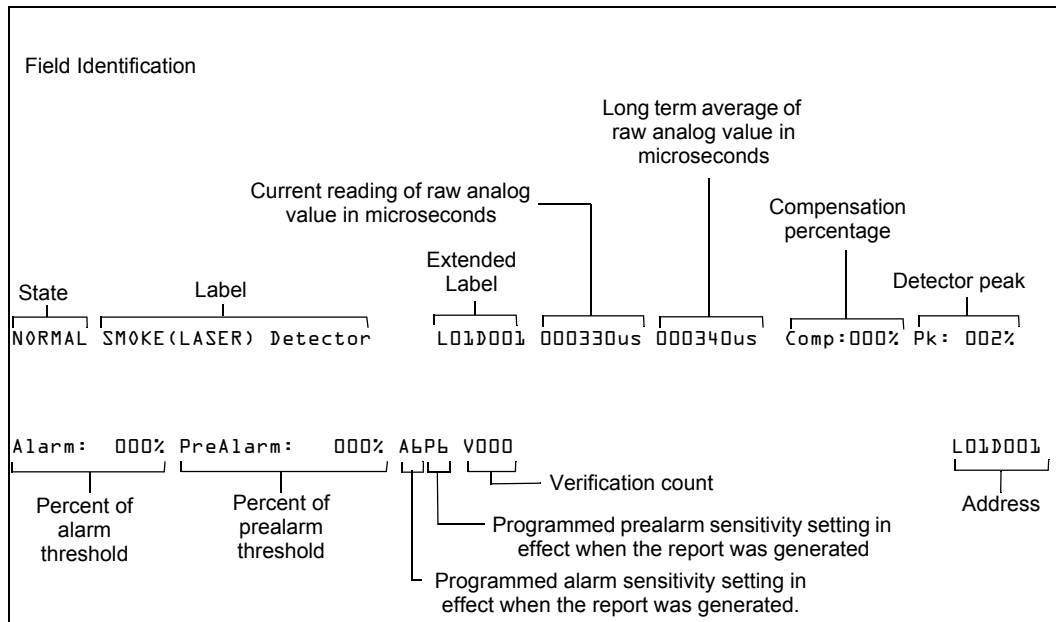


Figure D.7 Sample Detector Maintenance Report

## D.5.3 To Interpret a Detector Status Display or Maintenance Report

The Detector Read Status Screen and Detector Maintenance Report provides the same information (such as Device Status, Peak Value) about a detector. This section contains descriptions of each item that appears in a Detector Read Status Screen or a Detector Maintenance Report.

### Display Information

Lines 1- 4 - This could display any current event message, or, as in this example, the System Normal message

Line 5 - Screen title and the address of the point being read

The area between the separator lines, lines 6-14, shows all information concerning the selected point, which is L03D052 in the above example.

Line 6 - Line 6 displays two statistics that display for inputs (detectors and modules) and zones; in the above example they are:

AUTOMATIC INACTIVE

The first field displays the point control. There are three designations that could appear in this field

Point Control Designation	Description
AUTOMATIC	The point is being controlled automatically by the panel.
DISABLED	The point has been forced into a disabled state by an outside source.
TROUBLE	The point is in a trouble state and is no longer functioning automatically.

The second field displays the point status. There are two designations that could appear in this field.

Point Status Designation	Description
INACTIVE	The point is currently reporting no events.
ACTIVE	The point is currently in an off-normal status.
PREALARM	The point is currently in a prealarm status.

The device is a detector (an input device) so by referring to the descriptions below, it can be determined that the point is in a normal state.

### Inputs: (detectors, monitor modules, zones)

If the point is not in trouble or disabled, and the point is automatically controlled by the panel, the display will be one of the following:

AUTOMATIC INACTIVE

AUTOMATIC ACTIVE

AUTOMATIC PREALARM

If the point is disabled, the display will be one of the following. The Trouble Status field will appear if the point is in trouble.

DISABLED INACTIVE <Trouble Status>\*

DISABLED ACTIVE <Trouble Status>\*

DISABLED PREALARM <Trouble Status>\*

If the point is in trouble, the display will read:

TROUBLE INACTIVE <Trouble Status>\*

TROUBLE ACTIVE <Trouble Status>\*

TRouble PREALARM <Trouble Status>\*

\*The field <Trouble Status> will contain a device trouble message. Refer to this panel’s Operations manual for information on these messages.

Line 7 - The custom label for this point

Line 8 - Continuation of the point’s custom label, first zone, and device type

Lines 9, 10 - A display of all the zones that contain the current point being read.

Lines 11through 14 -These lines will have values in them only if the device is a detector. They will not display for wireless detectors.

Line 11

**VALUES:**

The screen displays the Alarm and Prealarm values that are in effect when read status is requested. For example, if occupied settings are in effect, occupied values will display  
**121% OF ALARM** - This field gives the detector reading as it relates to its preprogrammed alarm level value (indicated in the next line on the screen). The example above shows the detector exceeding the alarm level by 21%.

**145% OF PREALARM** - This field gives the detector reading as it relates to its preprogrammed prealarm level value (indicated in the next line on the screen). The example above shows the detector exceeding the prealarm level by 45%.

If the detector is an Alert heat detector, the value is indicated by a temperature reading (example: **148 DEGREES F**).

Line 12

The screen displays the Alarm and Prealarm levels that are in effect when read status is requested. For example, if unoccupied settings are in effect, they will display.

**ALARM: 6=1.66%** - Six is the preprogrammed alarm level value for this detector: its value is 1.66%, indicating the percent per foot obscuration value assigned to level 6.

**PREALARM: 3=0.47%** - Three is the preprogrammed alarm level value for this detector: its value is 0.47%, indicating the percent per foot obscuration value assigned to level 3.

Line 13

**ACTION/STATUS: NONE/VERY CLEAN** - This displays the maintenance status of the device. The message that appears in this field depends on the drift compensation value. A detector will automatically compensate for environmental contaminants and other factors over time, until the tolerance value has been exceeded. The FACP will signal a trouble condition when this level has been reached. Refer to the following table for messages and required action.

Message	Drift Compensation %	Description
None/Very Clean	Less than 50	No action necessary. The detector readings are near ideal.
None/Fairly Clean	50 - 69	No action necessary. The detector will activate at the selected sensitivity level.
Needs Cleaning	70 - 79	Clean the detector soon. The detector may cause a false alarm because it has reached the drift compensation tolerance value.
Needs Immediate Cleaning	80 - 100	Clean immediately! The detector is a false alarm risk. The drift compensation tolerance value has been exceeded.

**Table D.3 Drift Compensation Messages/Actions**

Line 13 will not display for Acclimate detectors.

## Line 14

**PEAKS: 56%** - This value represents the highest percent per foot obscuration reading taken by this detector. It can be a historical figure, and does not necessarily represent the highest reading for this particular alarm. Re-initializing the detector would reset this value to zero.

**VERIFY COUNT: 02** - This displays the number of times the detector has gone into alarm. This count aids in differentiating false alarms from actual alarms by showing repeated alarm events that have come into the device. In this example, the detector has gone into alarm two times since the verification count was begun. The FACP will signal a trouble condition when the verify count exceeds 20.

**CO-OP: D100-15B** - Indicates the address(es) of any detector(s) linked with the detector that's in alarm for Co-operative Multi-Alarm Sensing. This field will not display for Acclimate detectors.

Line 15 - The current time and date are displayed in this line.



## Notes

# Appendix E: CBE: Zones and Equations

CBE (Control-By-Event) is a software function that provides a means to program a variety of output responses based on various initiating events. The control panel operates CBE through lists of zones. A zone becomes listed when it is added to a point's zone map through point programming.

- Each input point (detector, monitor module) can list up to ten zones. Allowable zone types are general zone, releasing zone, and special zone.
- Each output point (control module) can list up to ten zones. Allowable zone types are general zone, logic zone, releasing zone, special zone, and trouble zone.
- Output points can list zone Z000 (general alarm). Non-Alarm or Supervisory points do not activate zone Z000 (general alarm).

Networked CBE, or CCBE (Cooperative Control-By-Event), provides CBE initiating-event/output-response relationships over the network through general, logic, and/or trouble zones. One of these zones, programmed into the zone maps of points on this panel and points on other nodes, will create network cause-and-effect relationships based on the type and content of the zone.

## E.1 Zones

There are four types of zones that may be listed to a point for CBE purposes.

Zone Type	Description/Function
General Zone	A general zone is used to link input and output devices. When an input device activates, any general zone in its zone map will be active, and any output device that has an active general zone in its map will be active. General zones can be used as arguments in logic equations. Zone Z000 is a general alarm zone: those points listing Z000 in their zone map participate in a general alarm. The panel will support up to 1000 general zones, designated as Z0 through Z999. General zones can be used in CCBE applications when a node number is entered before the zone number.
Logic Zone	A logic zone consists of a logic equation. Whenever the logic equation becomes true, all output points mapped to the logic zone will activate. The panel will support up to 1000 logic zones, designated as ZL1 through ZL1000. Logic zones can be used in CCBE applications when a node number is entered before the zone number.
Trouble Zone	A trouble zone consists of a trouble equation. Whenever the trouble equation becomes true, all output points mapped to the trouble zone will activate. The panel will support up to one hundred trouble zones, designated as ZT001 through ZT100. Trouble zones can be used in CCBE applications when a node number is entered before the zone number.  NOTE: Trouble zones can be used only in CCBE applications between NFS2-3030, NFS-3030 and NFS-640 FACPs. Trouble zones will not activate with other combinations.
Releasing Zone	A releasing zone is used to control a releasing operation. The panel will support up to ten releasing zones, designated as ZR00 through ZR09.

Special Zone	ZF0	An output participates in Presignal with this special zone in its zone map.
	ZF1 (Trouble less AC)	An output programmed to turn on/off if a system trouble - other than an AC power loss - occurs.
	ZF2 (AC Trouble)	An output programmed to turn on/off if an AC power loss or a brownout condition occurs.
	ZF3 (Security)	An output programmed to turn on/off if a Security input activates.
	ZF4 (Supervisory)	An output programmed to turn on/off if a Supervisory input activates.
	ZF5 Alternate Sensitivity Activation	An input programmed to switch from the active detector alarm sensitivities to the alternate alarm sensitivities when a non-fire point with ZF5 in its CBE activates.
	ZF6	Plant Isolate special zone for Australian Mode. When the Plant Isolate button is pressed, ZF6 will toggle between Normal and Active.
	ZF7	Drill for Australian Mode. In the event of a drill activation, ZF7 will activate and will remain active until a reset is performed on the fire panel.
	ZF9	An output programmed to turn on/off if a PreAlarm is active (ALERT, ACTION).
	ZF10	Any detector or module in alarm verification will activate this zone.
	ZF11	When the drill key is pushed or drill is performed, ZF11 will go active. ZF11 will go to normal after a 5 second delay.
	ZF12	When the acknowledge key is pushed, or a block or event acknowledge is performed, ZF12 will go active. After a five-second delay, ZF12 will go to normal.
	ZF13	When the signal silence key is pushed or a signal silence is performed, ZF13 will go active. After a five-second delay, ZF13 will go to normal.
	ZF14	When the system reset key is pushed or a system reset is performed, ZF14 will go active. After a ten-second delay, ZF14 will go to normal.
	ZF15	When there are disabled events present in the system, ZF15 will be set to active. When all disabled events have cleared, the state of ZF15 will go to normal.
	ZF16	Drill Zone. This zone used when Drill Mode is set to Custom. When a drill is performed on the fire panel, ZF16 will be set to active. ZF16 will return to normal following a system reset.
	ZF17	Signal Silence for Australian Mode operations. When a signal silence is performed, ZF17 will go active and will remain active until a System Reset is performed. The special zone will only function when Australian Mode is enabled.
	ZF18	CO Alarm. When a CO Alarm is present, ZF18 will activate.
	ZF19	CO Pre-Alarm. When a CO Pre-Alarm is present, ZF19 will activate.
	ZF20	When a mass notification alarm occurs on the fire panel, ZF20 will go active. If mass notification events have priority over fire, network nodes MN mapped to the fire panel (via VeriFire Tools) will suppress any active fire events. ZF20 will remain active until a system reset is performed and the MN alarm is cleared.
	ZF21	When a mass notification supervisory event occurs, ZF21 will activate. ZF21 will remain active until the MN Supervisory condition is cleared. If the supervisory is latched, a system reset will need to be performed to clear the condition.
	ZF22	When a mass notification trouble occurs on the fire panel, ZF22 will activate. ZF22 will remain active until the MN trouble is cleared
Time, date and holiday functions, which were formerly determined through special zones, are now defined in the panel programming section of this manual.		

Table E.1 Zone Table

## E.2 Equations

Logic and Trouble Equations can define complex relationships between input and output devices.

The FACP supports up to 1000 Logic Equations, each designated with a Logic Zone number of ZL1 through ZL1000. It also supports up to 100 Trouble Zones, each designated with a Trouble Zone number of ZT001 through ZT100. Once created, these equations can be included in input/output zone mapping.

1. Equations will always begin with a logic function. The function set is listed below.
2. Equations will be a maximum of 80 characters long, including parentheses and commas.
3. Logic and Trouble Equations can have a maximum of 10 logic functions unless a time delay function is used: a time delay function must be the only function in its equation.
4. Equations are evaluated after all other devices have been evaluated.

5. One logic equation can be used as an argument in another logic equation, or one trouble equation can be used in another trouble equation, only if the equation used has previously been evaluated; that is, only zones with a lower number than the zone currently being edited can be used as arguments.
6. A logic function can have a maximum of 20 arguments (inclusive start and stop address).
7. Maximum for the delay timer is 23 hours, 59 minutes, 59 seconds (23:59:59).
8. Mass Notification enabled systems: Logic zones must be written conditionally to ensure proper event suppression. Refer to the Mass Notification manual for additional information.

Equations are entered using Point Programming for logic or trouble zones. Refer to these sections in this manual for instruction. The panel will check for errors after the user has entered the complete equation. Possible errors are too many or too few parentheses, too many or too few arguments inside the parentheses, unknown function and unknown device type.

Equations are made up of two basic components: functions (either logic or time delay) and arguments.

## E.2.1 Arguments

Arguments are discrete parts of a logic or time delay function used in a logic or trouble equation. They can consist of another function, another equation, or any of the devices listed below.

LxxD1 - LxxD159	detectors loop xx	(159 per loop)
LxxM1 - LxxM159	modules loop xx	(159 per loop)
(Nxxx)Z0 - (Nxxx)Z999*	general zones	(1000)
ZF0 - ZF7, ZF9 - ZF22	special zones	(22)
T0 - T685	system troubles (trouble equations only)	(686)
(Nxxx)ZT001 - (Nxxx)ZT100	trouble zones	(100)
(Nxxx)ZL1 - (Nxxx)ZL1000	logic zones	(1000)
xx = loop number (01 through 10)		
(Nxxx) = Node number, necessary for CCBE programming. The node number identifies what node the panel will watch for a particular zone activation.		

**Table E.2 Table of Arguments**

## E.2.2 Logic Equations

### Logic Functions

- **The “AND” Operator**  
Requires that each argument be active.  
Example: AND(Z02,Z05,L2D12)  
All three arguments in the equation must be active for the logic zone to be activated.
- **The “OR” Operator**  
Requires that any argument be active  
Example: OR(Z02,Z05,L2D12)  
If any one of the three arguments in the equation is active the logic zone will be activated.
- **The “NOT” Operator**  
Inverts the state of the argument (activated to deactivated OR deactivated to activated).  
Example: NOT(Z02)  
The logic zone will remain activated until the argument activates.  
If the argument activates the logic zone will deactivate.
- **The “ONLY1” Operator**  
Requires that only one argument be active.  
Example: ONLY1(Z02,Z05,Z09)

If only one of the arguments activates the logic zone will be activated.

- **The “ANYX” Operator**

Requires that the amount of arguments specified by the number preceding the arguments be active.

Example: ANYX(2,Z02,Z05,Z09)

If any two or more of the arguments are in alarm the output point will be activated.

The X amount may be a value from 1 through 9.

- **The “XZONE” Operator**

Requires that any combination of two or more input devices programmed to a zone be active.




---

**NOTE:** Local General Zones only.

---

Example: XZONE(Z02)

If any combination of two or more initiating devices that have been mapped to this software zone come into alarm, then outputs mapped to this zone will activate.

- **The “RANGE” Operator**

Each argument within the range must conform to the requirements of the governing function. The range limit is 20 consecutive arguments.

Example: AND(RANGE(Z1,Z20))

Zone 1 through Zone 20 must all be active to activate the logic zone.

- **The “DIS(point argument)” Operator**

Requires that the point argument be disabled for the operator to go active.

- **The “PRE(point argument)” Operator**

Requires that the point argument be in prealarm for the operator to go active.

Example: AND(L1D1,PRE(L1D2))

The detector at address L1D1 must be active and the detector at L1D2 must be in prealarm for this equation to go active.

- **The “SUP(point argument)” Operator**

Requires that the point argument be in an active supervisory state for the operator to go active.

Example: OR(L1D1,SUP(L1M1))

The detector at address L1D1 must be active, or the module at L1M1 must be in an active supervisory state, for the equation to go active.

- **The “FIRE(point argument)” Operator**

Requires that the point argument be in an active fire alarm state for the operator to go active.

Example: AND(L1D1,FIRE(L1M1),FIRE(L1M2))

The detector at address L1D1 must be active, and the modules at L1M1 and L1M2 must be in an active fire alarm state, for the equation to go active.

- **The “NON(point argument)” Operator**

Requires that the point argument be in an active non-alarm state for the operator to go active.

Example: AND(L1D1,NON(L1M1))

The detector at address L1D1 must be active, and the module at address L1M1 must be in an active non-fire alarm state, for the equation to go active.

- **The “SEC(point argument)” Operator**

Requires that the point argument be in an active security alarm state for the operator to go active.

Example: AND(L1M1,SEC(L1M2))

The module at address L1M1 must be active, and the module at address L1M2 must be in an active security alarm state, for the equation to go active.

- **The “AUTO(point argument)” Operator\***

This operator will evaluate as “Active” if all of the SCS switches or specified switch group are in the “Auto” position. When the SCS-8L/SCE-8L is disabled, the evaluation will be based on the switch position prior to the disable.

Examples:

The switch associated with switch group 16 on Annunciator 1 must be set as “Auto” for the equation to go active.

OR(AUTO(A1G16))

All the switches of Annunciator 1 must be set to “Auto” for the equation to go active.

OR(AUTO(A1))

- **The “NORM(point argument)” Operator\***

This operator will evaluate as “Active” if the entire SCS device or a specified switch group is in a normal state.

Examples:

Switch group 16 on Annunciator 1 must be in the “normal” (no trouble) state for the equation to go active.

OR(NORM(A1G16))

(All switches groups on) Annunciator 1 must be in the “normal” (no trouble) state for the equation to go active.

OR(NORM(A1))

- **The “SCSDIS(point argument)” Operator\***

For use with the SCS-8L only. This operator will evaluate as “Active” if the keyswitch on the specified SCS device is in the disabled position.

Example:

If the keyswitch on annunciator 25 is disabled, this equation will go active.

OR(SCSDIS(A25))

\* For use with local SCS applications

## Time-based Functions

The panel supports three time-based functions: DEL, SDEL, and TIM. Special rules apply to an equation containing a time-based function:

- Only one time-based function may be used in an equation.
- The time-based function must appear only once, as the first entry of the equation.
- It may not be nested within parentheses in the equation.
- Logic functions may be used in an equation that begins with a DEL or SDEL time-based function: however, they must appear within parentheses following the time-based function.

Delay and duration times are in 24-hour format (HHMMSS); the allowable range is 00:00:00 to 23:59:59.

### The “DEL” Function

Used for delayed operation.

Example: DEL(HH.MM.SS, HH.MM.SS, AND(L1M1, L1M140))

- The first HH.MM.SS is the delay time, the second HH.MM.SS is the duration time. If the argument - AND(L1M1, L1M140) - in the example above activates, the function becomes true after the argument has been active for the delay time, and continues to be true for the

duration time as long as the argument stays active. If the argument goes inactive during the delay time or the duration time, the function reverts to false and the timing would begin all over again if reactivated.

- If duration time of zero is entered (00.00.00), the equation will evaluate true when the delay time expires if the argument remains active throughout the delay time period.
- If no duration or delay is specified, then the function will follow the input argument, indicating true while it is active and false when it is inactive. DEL assumes a value of false on reset.

### The “SDEL” Function

A latched version of the DEL function.

Example: SDEL(HH.MM.SS, HH.MM.SS,L1M140)

- The first HH.MM.SS is the delay time, the second HH.MM.SS is the duration time. If the argument (L1M140 in the example above) activates, the function becomes true after the delay time, and will remain active for the duration even if the argument becomes inactive during either the delay or duration time.
- If delay time of zero is entered (00.00.00), the equation will evaluate true as soon as the argument (L1M140) activates and will remain that way for the specified duration, even if the argument becomes inactive during that time.
- If no duration or delay time is specified, then the argument will not deactivate until reset, even if the argument becomes inactive.

### The “TIM” Operator

The TIM function is used to specify activation on specific days of the week or year.

Examples:

TIM(7-11-06) will evaluate as true for 24 hours starting at midnight (00:00:00) on July 11, 2006.

TIM(MO,TU,WE,TH,FR,08:00:00,23:00:00) will evaluate as true at 8:00 AM and remain true until 11:00 PM (23:00) for the list of days supplied.

TIM(MO,TU,WE,TH,FR,08:00:00) will evaluate as true at 8:00 AM and remain true until 23:59:59 of the current day for the list of days supplied.

TIM(TU,07:45:00,18:30:00) will evaluate as true every Tuesday between 7:45 AM until 6:30 PM.

TIM(MO,TU,WE,TH,FR) will evaluate as true from Monday morning at 12:01 AM until Friday evening at 11:59:00 PM.

### Logic Equation Syntax Example

**OR(AND(L1D1,L1D4),AND(L2D6,L2M3,NOT(L2M4)),ANYX(2,L1M13,L1M14,L1M15))**

Equation begins with a logic function - OR

67 Characters (maximum of 80) - includes parentheses and commas.

5 Logic Functions (maximum of 10) - OR, AND, AND, NOT and ANYX.

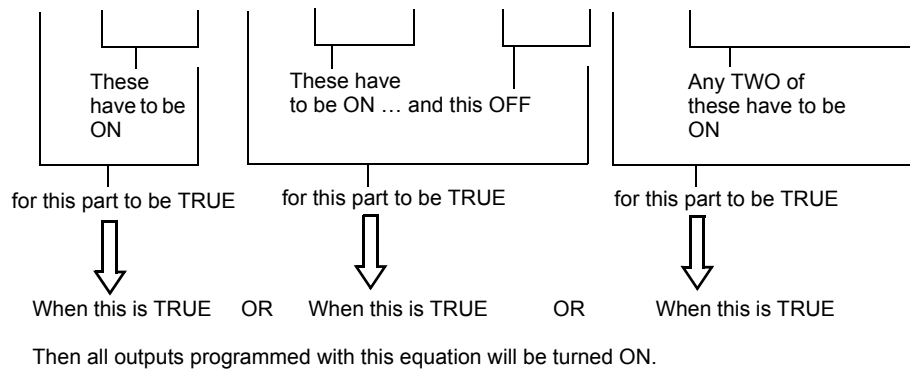
8 Arguments (maximum of 20 per logic function) - L1D1,L1D4,L2D6,L2M3,L2M4...

The equation contains no spaces.

### Evaluating an Equation

To evaluate an equation, start from the innermost part of the equation and work outwards. For this equation to evaluate TRUE and thus turn on any output mapped to it, the following conditions must be met:

OR(AND(L1D1,L1D4),AND(L2D6,L2M3,NOT(L2M4)),ANYX(2,L1M13,L1M14,L1M15))



## E.2.3 Trouble Equations

A trouble equation follows the same syntax rules as the logic equation. The system allows up to a hundred trouble equations, ZT001 through ZT100. It differs from a logic equation in the following manner:

- Equations evaluate as true when the arguments go into trouble.
- Argument entries may consist of system trouble codes. Refer to Appendix H, "System Troubles" for a listing of these codes.

Examples:

AND(L1M149,L2M110) will evaluate as true when both arguments go into trouble.

OR(ZT049,ZT050) will evaluate as true when either argument goes into trouble.



# Appendix F: Detector Initialization

## F.1 Overview

The control panel automatically performs a detector initialization routine when a detector is added or changed.

The detector initialization routine takes approximately 2.5 minutes. During this time, the detector being initialized does not perform fire protection functions. The LEDs of detectors polled in FlashScan mode will latch a steady green while initializing, and return to blinking green when initialization is over.

While initializing a detector, follow these guidelines:

- Make sure the detector is free of residual smoke during detector initialization.
- Do not test a detector during detector initialization.



---

**NOTE:** The control panel only performs detector initialization if it senses that a detector was removed for at least 15 seconds.

---



**WARNING:**

IF ANY DETECTOR IS REPLACED WITH A DIFFERENT TYPE OF DETECTOR (FOR EXAMPLE, A LASER DETECTOR IS REPLACED WITH A PHOTOELECTRIC DETECTOR), THE CONTROL PANEL MUST BE PROGRAMMED IMMEDIATELY WITH THE NEW DETECTOR TYPE CODE. FAILURE TO DO SO CAN CAUSE INCORRECT CONTROL PANEL OPERATION, INCLUDING FALSE ALARMS.

---

## F.2 To Replace a Detector with a Different Type of Detector

If one type of detector is replaced with a different type of detector, the control panel must immediately be programmed for the new detector type. To replace a detector, follow these steps:

Step	Action
1	Delete the old detector point from FACP programming using the “Delete Point” screen on page 71.
2	Physically remove the old detector.
3	Enter point programming for this point and change the Type and FlashScan Code Label to the values appropriate for the new detector. (Refer to Section 3.4.1, “Detector Point”, on page 47 for programming instructions).
4	Physically install the new detector. Initialization will occur automatically

# Appendix G: Type Codes

## G.1 What Are Type Codes?

Type Codes are software selections for initiating devices (detectors and monitor modules) and output devices (control modules and NACs). Some Type Codes are self-explanatory; that is, the Type Code matches the function of the device, such as a “Monitor” for a monitor module, “Smoke(photo)” for a photoelectric detector, and so on. Type codes also provide special functions, such as activating switches, solenoids, and control panel functions. FlashScan devices are assigned a special FlashScan code.

## G.2 How to Select a Type Code

Type Codes are selected at the Point Programming screens. Refer to the Point Program section of this manual for instructions.

This appendix contains detailed descriptions of Type Codes for input and output devices, as listed below:

Type of Device	Refer to page
Intelligent Detectors	page 154
Monitor Modules	page 156
SLC Outputs	page 157
FlashScan Codes	page 159

## G.3 Type Codes for Input Devices

### G.3.1 Overview

This section provides a list of Type Codes for intelligent detectors and for monitor modules. The following Point Types light an LED at the panel when activated.

- fire alarm - lights the FIRE ALARM LED
- supervisory - lights the SUPERVISORY LED
- security - lights the SECURITY LED
- trouble - lights the TROUBLE LED

### G.3.2 Type Codes for Intelligent Detectors

Following is a list of intelligent detector Type Codes, which specify the type of detector installed at an SLC address.

Point Characteristics				
Type Code	Point Type	Latching (Y=yes N=no)	Activates CBE	Device/Point Function
ASPIRATION	fire	Y	Y	Aspiration laser or Intelligent Aspiration detector
ASPIR. (SUP)	supervisory	Y	Y	Supervisory for an Intelligent Aspiration detector
ASPIR. (PRE)	prealarm	N	Y	Pre-alarm for an Intelligent Aspiration detector
ASPIR. (NON)	non-fire	N	Y	Non-fire for an Intelligent Aspiration detector
ASPIR. REF	non-fire	N	Y	Reference for an Intelligent Aspiration detector
Note for Aspiration detector programming: The FAAST Intelligent Aspiration detector requires five (5) SLC device addresses. Refer to the FAAST Installation document for additional programming information.				
SMOKE (ION)	fire	Y	Y	Ionization smoke detector
SUP L(ION)*	supervisory	Y	Y	Ionization smoke detector
SUP T(ION)*†	supervisory	N	Y	Ionization smoke detector

Table G.1 Intelligent Detector Type Codes (1 of 2)

Point Characteristics				
Type Code	Point Type	Latching (Y=yes N=no)	Activates CBE	Device/Point Function
SMOKE(DUCTI)	fire	Y	Y	Duct Ionization smoke detector
SUP L(DUCTI)	supervisory	Y	Y	Duct ionization smoke detector
SUP T(DUCTI)†	supervisory	N	Y	Ionization smoke detector used as a duct detector to report supervisory condition rather than alarm.
SMOKE(PHOTO)	fire	Y	Y	Photoelectric smoke detector
SUP L(PHOTO)*	supervisory	Y	Y	Photoelectric smoke detector
SUP T(PHOTO)*†	supervisory	N	Y	Photoelectric smoke detector
SMOKE(DUCTP)	fire	Y	Y	Duct Photoelectric smoke detector
SUP L(DUCTP)	supervisory	Y	Y	Photoelectric smoke detector used as a duct detector to report supervisory condition rather than alarm
SUP T(DUCTP)†	supervisory	N	Y	Photoelectric smoke detector used as a duct detector to report supervisory condition rather than alarm.
RFSMOKE(PHOTO)	fire	Y	Y	Wireless Photoelectric smoke detector
SMOKE(HARSH)	fire	Y	Y	HARSH smoke detector
SMOKE(LASER)	fire	Y	Y	Laser smoke detector
SUP T (LASER)*†	supervisory	N	Y	Laser Smoke Detector
SUP L (LASER)*	supervisory	Y	Y	Laser Smoke Detector
SMOKE(DUCTL)	fire	Y	Y	Duct Laser smoke detector
SUP L(DUCTL)	supervisory	Y	Y	Laser smoke detector used as a duct detector to report supervisory condition rather than alarm.
SUP T(DUCTL)	supervisory	N	Y	Laser smoke detector used as a duct detector to report supervisory condition rather than alarm.
PHOTO/CO	fire	Y	Y	Combination Photoelectric/CO detector
P/CO (P SUP)*	fire	Y	Y	Combination Photoelectric/CO detector. Photo element activation generates a supervisory condition.
P/CO (C SUP)	fire	Y	Y	Combination Photoelectric/CO detector. CO element activation generates a supervisory condition.
AIR REF	fire	Y	Y	Assign to one or more FSL-751 detectors used to monitor the quality of air entering the protected area. The air quality measurement allows the VIEW system to compensate for vehicle fumes, fog, or other particles brought into the protected area through the ventilation system. Poor air quality will lower the sensitivity of all FSL-751 detectors on the SLC. The detector sensitivity, however, remains within approved limits (always less than 1% obscuration per foot).
Note: A reference detector still functions as a smoke detector, but the detector sensitivity level should be set to the least sensitive level—AL:9 and PA:9 Alarm and Pre-Alarm sensitivity. Refer to "Detector Sensitivity Settings" on page 138 for a complete list of detector sensitivity settings.				
HEAT	fire	Y	Y	190°F heat detector
HEAT+	fire	Y	Y	190°F heat detector with low temperature warning
HEAT(FIXED)	fire	Y	Y	135°F intelligent thermal sensor
HEAT (ROR)	fire	Y	Y	15°F per minute rate-of-rise detector
SMOKE ACCLIM	fire	Y	Y	Combination Photoelectric/heat detector
SMOKE(ACCLI+)	fire	Y	Y	Combination Photoelectric/heat detector with low temperature warning, or Intelliquad FSC-851 Photoelectric Multi-Criteria Smoke Sensor.
SMOKE(MULTI)‡	fire	Y	Y	Multisensor smoke detector
SMOKE(BEAM)	fire	Y	Y	Beam Smoke Detector

Table G.1 Intelligent Detector Type Codes (2 of 2)

- \* Use only with approval of AHJ
- † Not suitable for Canadian applications
- ‡ CLIP Mode only

### G.3.3 Type Codes for Monitor Modules

Following is a list of monitor module Type Codes, which can be used to change the function of a monitor module point.

Type Code	Point Type	Point Characteristics		
		Latching (Y=yes N=no)	Activates CBE	Device Function
MONITOR	fire alarm	Y	Y	Alarm-monitoring device
NC MONITOR	fire alarm	Y	Y	Alarm monitoring device, where an open circuit=active.
PULL STATION	fire alarm	Y	Y	Manual fire-alarm-activating device
SMOKE CONVEN	fire alarm	Y	Y	Indicates activation of a conventional smoke detector. An FZM-1 must be used for alarm verification of a two-wire conventional detector.
SMOKE DETECT	fire alarm	Y	Y	Indicates activation of a conventional smoke detector. An FZM-1 must be used for alarm verification of a two-wire conventional detector
WATERFLOW	fire alarm	Y	Y	Monitor for waterflow alarm switch
WATERFLOW S	supervisory	Y	Y	Indicates supervisory condition for activated waterflow switch
ACCESS MONTR	non-alarm security	N	Y	Used for monitoring building access
AREA MONITOR	security	Y	Y	Monitors building access
AUDIO SYSTEM	trouble	N	N	Used for monitoring audio equipment (use trouble zones for activations)
EQUIP MONITR	non-alarm security	N	Y	Used for monitoring equipment
FMM 4-20	user-programmable	Y	Y	Monitors 4-20 mA industrial sensors.
SECURITY L	security	Y	Y	Indicates activation of security alarm
LATCH SUPERV	supervisory	Y	Y	Indicates latching supervisory condition
NC SUP L	supervisory	Y	Y	Indicates latching supervisory condition, where an open circuit=active.
TRACK SUPERV	supervisory	N	Y	Monitors for waterflow tamper switches for alarm points
NC SUP T	supervisory	N	Y	Indicates tracking supervisory condition, where an open circuit=active.
SPRINKLR SYS	supervisory	Y	Y	Monitors a waterflow device
SYS MONITOR	security	Y	Y	Monitors equipment security
TAMPER	supervisory	Y	Y	Indicates activation of tamper switch
ACK SWITCH	non-alarm	N	N	Performs Acknowledge function
ALLCALL PAGE	non-alarm	N	Y	Performs function AMG-1 All-call and telephone page
DRILL SWITCH	non-alarm*	Y	N	Performs Drill function
EVACUATE SWITCH	non-alarm*	Y	N	Performs Drill function, activates silenceable fire outputs
FIRE CONTROL	non-alarm	N	Y	Monitors non-fire activations
NON FIRE	non-alarm	N	Y	Monitors non-fire activations
NC NON FIRE	non-alarm	N	Y	Monitors non-fire activations, where an open circuit=active.
PAS INHIBIT	non-alarm	N	N	Inhibits Positive Alarm Sequence
POWER MONITR	trouble†	N	N	Monitors main and auxiliary power supplies (use trouble zones for activations)
RESET SWITCH	non-alarm	N	N	Performs Reset function
SIL SWITCH	non alarm	N	N	Performs Signal Silence function
TELE PAGE	non-alarm	N	Y	Performs function of page button on FFT-7. Allows remote paging to a fire area
DISABLE MON	disable	N	N	When this point activates it will create a disable on the panel for that point. No CBE generated. Modules can not be disabled via ACS, Alter Status, or over the network.
TROUBLE MON	trouble	N	N	Monitors trouble inputs (use trouble zones for activations)
Blank	fire alarm	Y	Y	Monitors for a device with no description

**Table G.2 Type Codes for Monitor Modules (1 of 2)**

Type Code	Point Type	Point Characteristics		
		Latching (Y=yes N=no)	Activates CBE	Device Function
HEAT DETECT	fire alarm	Y	Y	Monitors for conventional heat detector
RF MON MODUL	fire alarm	Y	Y	Wireless alarm-monitoring device
RF PULL STA	fire alarm	Y	Y	Wireless manual fire-alarm-activating device
RF SUPERVSRY	supervisory	N	Y	Wireless supervisory-monitoring device
ABORT SWITCH	non-alarm	N	Y	Provides an abort function through a monitor module (connected to a UL-listed abort station) for a releasing zone.
MAN RELEASE	fire alarm†	Y	Y	Provides a manual release through a monitor module (connected to a UL-listed pull station) for a releasing zone
MAN REL DELAY	fire alarm†	Y	Y	Provides a manual release with a 10-second delay through a monitor module (connected to a UL-listed pull station) for a releasing zone
SECOND SHOT	fire alarm†	Y	Y	Provides a second manual release through a monitor module (connected to a UL-listed pull station) for a releasing zone
HAZARD ALRT	non-fire	N	Y	Monitors for a hazard alert
WEATHER ALRT	non-fire	N	Y	Monitors for a weather alert
PROCESS MON	critical process	Y	Y	Monitors for a critical process
PROCESS AUTO	critical process	N	Y	Monitors for a critical process
CO MONITOR	CO alarm	Y	Y	Monitors conventional CO detectors for a CO alarm condition.
ECS/MN MON	alarm	Y	Y	Monitors mass notification devices for alarm activation.
ECS/MN SUPT	supervisory	N	Y	Tracking supervisory monitor for mass notification devices.
ECS/MN SUPL	supervisory	Y	Y	Latching supervisory monitor for mass notification devices.
ECS/MN TMON	trouble	N	Y	Trouble monitor for mass notification devices.
RF GATEWAY	non-alarm	N	Y	Provides communication between wireless devices and the fire panel
ALARM TRACK**	alarm	N	Y	This unit must be installed in accordance with the following requirements: Monitor modules located within the protected premises which are responsible for supervising the state of the protected premises control unit may be programmed for Tracking (non-latching) operation. The supervised protected premises control unit shall be responsible for all notification and evacuation

Table G.2 Type Codes for Monitor Modules (2 of 2)

- \* Local Mode treats this point as a fire alarm point.
- † Does not participate in Local Mode
- ‡ Local Mode activation of NACs only. No releasing.
- \*\* Does not activate General Alarm Zone Z0

## G.4 Type Codes for Output Devices

This section provides a list of Type Codes for SLC control module points. Select from these codes to define the type of point.

Type Code	Silenceable (Y=yes N=no)*	Switch Inhibit (Y=yes, N=No)*	Walk Test (Y=yes, N=No)*	SLC Output Point	Local Mode Group Point Types	Device Function
CONTROL†	Y	N	Y	NAC	n/a	Supervised NAC
RELAY†	Y	N	Y	Relay	n/a	Relay output
BELL CIRCUIT	Y	N	Y	NAC	fire	Supervised NAC
STROBE CKT†	Y	N	Y	NAC	fire	Supervised NAC
HORN CIRCUIT†	Y	N	Y	NAC	fire	Supervised NAC
AUDIBLE CKT	Y	N	Y	NAC	fire	Supervised NAC
SPEAKER	Y	N	Y	NAC	fire	Supervised NAC for speaker circuits
blank†	Y	N	Y	NAC	n/a	Supervised NAC for undefined device
NONRESET CTL†	N	N	N	Relay or NAC	n/a	Supervised output, unaffected by "System Reset" command
TELEPHONE	N	N	N	Relay	fire	Supervised Telephone circuit
CONTROL NAC	Y	N	Y	NAC	fire	Supervised NAC

Table G.3 SLC Control Module Type Codes (1 of 2)

ISOLATED NAC	Y	N	Y	NAC	fire	Supervised NAC for notification appliance, used with audio isolators. Activates even if there is a short on its NAC circuit. For ULC installations only.
ISOLATED SPK	Y	N	Y	NAC	fire	Supervised NAC for speaker circuits, used with audio isolators. Activates even if there is a short on its audio circuit. For ULC installations only.
GEN ALARM†	N	Y	Y	NAC	fire	Control Module, XPC-8, or an XP5-C (in NAC mode) configured as a Municipal Box Transmitter for NFPA 72 Auxiliary Fire Alarm Systems applications (MBT-1 required). This Type ID can also be used for general alarm activation.
GEN SUPERVIS†	N	Y	Y	NAC	supervisory	Control Module, XPC-8, or an XP5-C (in NAC mode) activated under any Supervisory condition (includes sprinkler type).
GEN TROUBLE†	N	Y	Y	NAC	trouble	Control Module, XPC-8, or an XP5-C (in NAC mode) activated under any System Trouble condition. This device will not turn ON when it is in trouble (short or open).
GENERAL PEND†	N	Y	Y	NAC	trouble	Control Module XPC-8 circuit, or an XP5-C (in NAC mode) that will activate upon receipt of an alarm and/or trouble condition, and remain in the ON state until all events have been ACKNOWLEDGED. This device will not turn ON when it is in trouble (short or open)
TROUBLE PEND†	N	Y	Y	NAC	trouble	Control Module or an XP5-C (in NAC mode) that will activate upon receipt of a trouble condition, and remain in the ON state until all troubles have been ACKNOWLEDGED. This device will not turn ON when it is in trouble (short or open).
ALARMS PEND†	N	Y	Y	NAC	fire	Control module or NAC for output that will activate upon receipt of an alarm condition, and remain in the alarm state until all alarms have been acknowledged.
INST RELEASE‡	N	Y	N	NAC (SLC only)	fire	Supervised for open circuits and ground faults. Short = normal
REL. FORM C†‡	N	Y	N	Form-C relay (SLC only)	n/a	Directs relay outputs to perform a releasing function.
RELEASE CKT†‡	N	Y	N	NAC (SLC only)	n/a	Directs outputs to perform a releasing function. Supervised for open circuits and ground faults. Short = normal
REL CKT ULC†‡	N	Y	N	NAC (SLC only)	n/a	Directs outputs to perform a release function as required by ULC.
REL END BELL	N	Y	N	NAC	n/a	Activates NAC audio or visual device when releasing circuits shut off.
REL AUDIBLE	Y	Y	N	NAC	n/a	Activates audio or visual devices steady when releasing starts.
FORM C RESET†	N	Y	N	Form-C Relay (SLC only)	n/a	Relay module used to interrupt 24V power to four-wire conventional detectors for 30 seconds upon reset. Used in conjunction with a monitor module with a conventional detector Type ID
MNS GENERAL	N	N	N	NAC	n/a	Activates NAC mass notification devices when an MNS event occurs
MNS STROBE	N	N	N	NAC	n/a	Activates strobe mass notification devices when an MNS event occurs
MNS SPEAKER	N	N	N	NAC	n/a	Activates speaker mass notification devices when an MNS event occurs
MNS CONTROL	N	N	N	NAC	n/a	Activates control module mass notification devices when an MNS event occurs
MNS RELAY	N	N	N	Relay	n/a	Activates relay mass notification devices when an MNS event occurs

**Table G.3 SLC Control Module Type Codes (2 of 2)**

\* Values represent program defaults

† With LCM-320 revision 2.0 and higher, this Type Code has external power supervision (FlashScan only). An external power-supervision relay is not required. Note that Type Codes RELAY, REL FORM C, and FORM C RESET are for use only with FRM-1 modules. Refer to the section on devices requiring external power supervision in this panel's installation manual

‡ The FCM-1-REL checks for shorts with all releasing type codes.

## G.5 FlashScan Codes

This section provides a list of FlashScan Codes for FlashScan SLC devices. Select from these codes to define the type of point:

Label	Device/Point
<b>FlashScan Codes</b>	
4-20MA	FMM-4-20
ACCLIMATE	FAPT-751, FAPT-851
BEAM	FSB-200,FSB-200S
IQUAD	FSC-851,FCO-851
CONTROL	FCM-1
FAAST	FSA-8000
HEAT	FST-751/R, FST-851/R
HIGH HEAT	FST-851H
ION	FSI-751, FSI-851
LASER	FSL-751
MANUAL STATION	FSM-101 (NBG-12LX Series)
MINI/DUAL MONITOR	FMM-101,FDM-1
WIRELESS PULL STATION	FW-MM
WIRELESS MONITOR	FW-MM
WIRELESS GATEWAY	FWSG
WIRELESS HEAT	FWH-200FIX135, FWH-200ROR135
WIRELESS PHOTO	FWD-200P
WIRELESS ACCLIMATE	FWD-200ACCLIMATE
MONITOR	FMM-1
PHOTO	FSP-751,FSD-751P/RP, FSP-851, FSD-751PL/RPL, FSH-751
PHOTO/HEAT	FSP-751T, FSP-851T
PHOTO/CO	FCO-851
PS MON	PS MON
PS CONTROL	ACPS CONTROL
PS RELAY	ACPS RELAY
RELAY	FRM-1
RELEASE	FCM-1-REL
RFX MON	RFX MON
RFX SMOKE	SDRF-751
RFX SUP	RFX SUP
TELEPHONE	FTM-1
XPIQ BATTERY	XPIQ BAT MON
XPIQ GND FLT	XPIQ EF MON
XPIQ AC	XPIQ AC MON
XPIQ TROUBLE	XPIQ GEN MON
XPIQ STROBE	XPIQ STROBE
XPIQ SPEAKER	XPIQ SPEAKER
XPIQ TELEPHONE	XPIQ TELEPHONE
XPIQ MUSIC	XPIQ MUSIC
ZONE MONITOR	FZM-1

**Table G.4 FlashScan Codes**

# Appendix H: System Troubles

Table H.1 is a list of System Troubles that could occur during the course of FACP operation. The System Trouble Name column is the text that displays in the system trouble message. The System Trouble Index is the number associated with the trouble in FACP memory. It is the number that can be used as an argument in a Trouble Equation.

System Trouble Index	System Trouble Name	System Trouble Index	System Trouble Name	System Trouble Index	System Trouble Name	System Trouble Index	System Trouble Name
0	GROUND FAULT	61	ANNUN 24 TROUBLE	184	STYLE 6 NEG LOOP 3	246	RESERVED
1	AC FAIL	62	ANNUN 24 NO ANSWER	186	STYLE 6 NEG LOOP 5	247	RESERVED
2	BATTERY	63	ANNUN 25 TROUBLE	187	STYLE 6 NEG LOOP 6	248	RESERVED
3	STYLE 6 POS LOOP 1	64	ANNUN 25 NO ANSWER	188	STYLE 6 NEG LOOP 7	249	RESERVED
4	STYLE 6 POS LOOP 2	65	ANNUN 26 TROUBLE	189	STYLE 6 NEG LOOP 8	250	SELF TEST FAILED
5	CORRUPT LOGIC EQUAT	66	ANNUN 26 NO ANSWER	190	STYLE 6 NEG LOOP 9	251	NETWORK INCOMPATIBILITY
6	LCD80 SUPERVISORY	67	ANNUN 27 TROUBLE	191	STYLE 6 NEG LOOP 10	252	RESERVED
7	EPROM ERROR	68	ANNUN 27 NO ANSWER	192	STYLE 6 POS LOOP 3	253	NETWORK MAP LIMIT EXCEEDED
8	INTERNAL RAM ERROR	69	ANNUN 28 TROUBLE	193	STYLE 6 POS LOOP 4	254	INVALID NODE TYPE
9	EXTERNAL RAM ERROR	70	ANNUN 28 NO ANSWER	194	STYLE 6 POS LOOP 5	255	DISPLAY NODE LIMIT EXCEEDED
10	PROGRAM CORRUPTED	71	ANNUN 29 TROUBLE	195	STYLE 6 POS LOOP 6	256-383	RESERVED
11	NO DEV INST ON L1	72	ANNUN 29 NO ANSWER	196	STYLE 6 POS LOOP 7	384	REMOTE DISPLAY 1 TROUBLE
12	PANEL DOOR OPEN	73	ANNUN 30 TROUBLE	197	STYLE 6 POS LOOP 8	385	REMOTE DISPLAY 1 NO ANSWER
13	AUXILIARY TROUBLE	74	ANNUN 30 NO ANSWER	198	STYLE 6 POS LOOP 9	386	REMOTE DISPLAY 2 TROUBLE
14	RESERVED	75	ANNUN 31 TROUBLE	199	STYLE 6 POS LOOP 10	387	REMOTE DISPLAY 2 NO ANSWER
15	ANNUN 1 TROUBLE	76	ANNUN 31 NO ANSWER	200	RESERVED	388	REMOTE DISPLAY 3 TROUBLE
16	ANNUN 1 NO ANSWER	77	ANNUN 32 TROUBLE	201	BUZZER OFF-LINE	389	REMOTE DISPLAY 3 NO ANSWER
17	ANNUN 2 TROUBLE	78	ANNUN 32 NO ANSWER	202	RESERVED	390	REMOTE DISPLAY 4 TROUBLE
18	ANNUN 2 NO ANSWER	79	NETWORK FAIL PORT A	203	RESERVED	391	REMOTE DISPLAY 4 NO ANSWER
19	ANNUN 3 TROUBLE	80	NETWORK FAIL PORT B	204	RESERVED	392	REMOTE DISPLAY 5 TROUBLE
20	ANNUN 3 NO ANSWER	81	NETWORK FAILURE	205	RESERVED	393	REMOTE DISPLAY 5 NO ANSWER
21	ANNUN 4 TROUBLE	82	ADV WALK TEST	206	PRINTER PAPER OUT	394	REMOTE DISPLAY 6 TROUBLE
22	ANNUN 4 NO ANSWER	83	CHARGER FAIL	207	PRINTER OFF LINE	395	REMOTE DISPLAY 6 NO ANSWER
23	ANNUN 5 TROUBLE	84	GROUND FAULT LOOP 2	208	RESERVED	396	REMOTE DISPLAY 7 TROUBLE
24	ANNUN 5 NO ANSWER	85	STYLE 6 NEG LOOP 1	209	RESERVED	397	REMOTE DISPLAY 7 NO ANSWER
25	ANNUN 6 TROUBLE	86	STYLE 6 NEG LOOP 2	210	MANUAL MODE ENTERED	398	REMOTE DISPLAY 8 TROUBLE
26	ANNUN 6 NO ANSWER	87	GROUND FAULT LOOP 1	211	NCM COMM LOSS	399	REMOTE DISPLAY 8 NO ANSWER
27	ANNUN 7 TROUBLE	88	RESERVED	212	STYLE 4 SHORT A LOOP 1	400	REMOTE DISPLAY 9 TROUBLE
28	ANNUN 7 NO ANSWER	89	RESERVED	213	STYLE 4 SHORT B LOOP 1	401	REMOTE DISPLAY 9 NO ANSWER
29	ANNUN 8 TROUBLE	90	PROG MODE ACTIVATED	214	STYLE 4 SHORT A LOOP 2	402	REMOTE DISPLAY 10 TROUBLE
30	ANNUN 8 NO ANSWER	91	LOADING...NO SERVICE	215	STYLE 4 SHORT B LOOP 2	403	REMOTE DISPLAY 10 NO ANSWER
31	ANNUN 9 TROUBLE	92	BASIC WALK TEST	216	STYLE 4 SHORT A LOOP 3	404	REMOTE DISPLAY 11 TROUBLE
32	ANNUN 9 NO ANSWER	93	NFPA 24HR REMINDER	217	STYLE 4 SHORT B LOOP 3	405	REMOTE DISPLAY 11 NO ANSWER
33	ANNUN 10 TROUBLE	94	NVRAM BATT TROUBLE	218	STYLE 4 SHORT A LOOP 4	406	REMOTE DISPLAY 12 TROUBLE
34	ANNUN 10 NO ANSWER	95	RESERVED	219	STYLE 4 SHORT B LOOP 4	407	REMOTE DISPLAY 12 NO ANSWER
35	ANNUN 11 TROUBLE	96	RESERVED	220	STYLE 4 SHORT A LOOP 5	408	REMOTE DISPLAY 13 TROUBLE
36	ANNUN 11 NO ANSWER	97	RESERVED	221	STYLE 4 SHORT B LOOP 5	409	REMOTE DISPLAY 13 NO ANSWER
37	ANNUN 12 TROUBLE	98	RESERVED	222	STYLE 4 SHORT A LOOP 6	410	REMOTE DISPLAY 14 TROUBLE
38	ANNUN 12 NO ANSWER	99	RESERVED	223	STYLE 4 SHORT B LOOP 6	411	REMOTE DISPLAY 14 NO ANSWER
39	ANNUN 13 TROUBLE	100	RESERVED	224	STYLE 4 SHORT A LOOP 7	412	REMOTE DISPLAY 15 TROUBLE
40	ANNUN 13 NO ANSWER	101	RESERVED	225	STYLE 4 SHORT B LOOP 7	413	REMOTE DISPLAY 15 NO ANSWER
41	ANNUN 14 TROUBLE	102	RESERVED	226	STYLE 4 SHORT A LOOP 8	414	REMOTE DISPLAY 16 TROUBLE
42	ANNUN 14 NO ANSWER	103	RESERVED	227	STYLE 4 SHORT B LOOP 8	415	REMOTE DISPLAY 16 NO ANSWER
43	ANNUN 15 TROUBLE	104	RESERVED	228	STYLE 4 SHORT A LOOP 9	416	REMOTE DISPLAY 17 TROUBLE
44	ANNUN 15 NO ANSWER	105	STYLE 6 ON LOOP 3	229	STYLE 4 SHORT B LOOP 9	417	REMOTE DISPLAY 17 NO ANSWER
45	ANNUN 16 TROUBLE	106	RESERVED	230	STYLE 4 SHORT A LOOP 10	418	REMOTE DISPLAY 18 TROUBLE
46	ANNUN 16 NO ANSWER	107	RESERVED	231	STYLE 4 SHORT B LOOP 10	419	REMOTE DISPLAY 18 NO ANSWER
47	ANNUN 17 TROUBLE	108	MAN EVAC INITIATED	232	RESERVED	420	REMOTE DISPLAY 19 TROUBLE
48	ANNUN 17 NO ANSWER	109	MAN EVAC RECEIVED	233	STYLE 6 SHORT LOOP 1	421	REMOTE DISPLAY 19 NO ANSWER
49	ANNUN 18 TROUBLE	110	RESERVED	234	STYLE 6 SHORT LOOP 2	422	REMOTE DISPLAY 20 TROUBLE
50	ANNUN 18 NO ANSWER	111	RESERVED	235	STYLE 6 SHORT LOOP 3	423	REMOTE DISPLAY 20 NO ANSWER
51	ANNUN 19 TROUBLE	112	RESERVED	236	STYLE 6 SHORT LOOP 4	424	REMOTE DISPLAY 21 TROUBLE
52	ANNUN 19 NO ANSWER	113-175	RESERVED	237	STYLE 6 SHORT LOOP 5	425	REMOTE DISPLAY 21 NO ANSWER
53	ANNUN 20 TROUBLE	176	GROUND FAULT LOOP 3	238	STYLE 6 SHORT LOOP 6	426	REMOTE DISPLAY 22 TROUBLE
54	ANNUN 20 NO ANSWER	177	GROUND FAULT LOOP 4	239	STYLE 6 SHORT LOOP 7	427	REMOTE DISPLAY 22 NO ANSWER
55	ANNUN 21 TROUBLE	178	GROUND FAULT LOOP 5	240	STYLE 6 SHORT LOOP 8	428	REMOTE DISPLAY 23 TROUBLE
56	ANNUN 21 NO ANSWER	179	GROUND FAULT LOOP 6	241	STYLE 6 SHORT LOOP 9	429	REMOTE DISPLAY 23 NO ANSWER
57	ANNUN 22 TROUBLE	180	GROUND FAULT LOOP 7	242	STYLE 6 SHORT LOOP 10	430	REMOTE DISPLAY 24 TROUBLE
58	ANNUN 22 NO ANSWER	181	GROUND FAULT LOOP 8	243	NCM COM LOSS	431	REMOTE DISPLAY 24 NO ANSWER
59	ANNUN 23 TROUBLE	182	GROUND FAULT LOOP 9	244	RESERVED	432	REMOTE DISPLAY 25 TROUBLE
60	ANNUN 23 NO ANSWER	183	GROUND FAULT LOOP 10	245	RESERVED	433	REMOTE DISPLAY 25 NO ANSWER

Table H.1 System Trouble Names and Codes (1 of 2)



System Trouble Index	System Trouble Name	System Trouble Index	System Trouble Name	System Trouble Index	System Trouble Name	System Trouble Index	System Trouble Name
434	REMOTE DISPLAY 26 TROUBLE	535	RESERVED	583	LOCAL PHONE TROUBLE	640	PRIMARY AMP 2 OVERCURRENT
435	REMOTE DISPLAY 26 NO ANSWER	536	RESERVED	584	ANALOG OUTPUT A TROUBLE	641	PRIMARY AMP 3 OVERCURRENT
436	REMOTE DISPLAY 27 TROUBLE	537	RESERVED	585	ANALOG OUTPUT B TROUBLE	642	PRIMARY AMP 4 OVERCURRENT
437	REMOTE DISPLAY 27 NO ANSWER	538	RESERVED	586	ANALOG OUTPUT C TROUBLE	643	BACKUP AMP 1 OVERCURRENT
438	REMOTE DISPLAY 28 TROUBLE	539	RESERVED	587	ANALOG OUTPUT D TROUBLE	644	BACKUP AMP 2 OVERCURRENT
439	REMOTE DISPLAY 28 NO ANSWER	540	RESERVED	588	FLASH IMAGE ERROR	645	BACKUP AMP 3 OVERCURRENT
440	REMOTE DISPLAY 29 TROUBLE	541	RESERVED	589	POWER SUPPLY TROUBLE	646	BACKUP AMP 4 OVERCURRENT
441	REMOTE DISPLAY 29 NO ANSWER	542	RESERVED	590	AMPLIFIER LIMIT	647	PRIMARY AMP 1 TRIP
442	REMOTE DISPLAY 30 TROUBLE	543	RESERVED	591	AMPLIFIER SUPERVISION	648	PRIMARY AMP 2 TRIP
443	REMOTE DISPLAY 30 NO ANSWER	544	RESERVED	592	DAA ADDRESS CONFLICT	649	PRIMARY AMP 3 TRIP
444	REMOTE DISPLAY 31 TROUBLE	545	RESERVED	593	Reserved	650	PRIMARY AMP 4 TRIP
445	REMOTE DISPLAY 31 NO ANSWER	546	RESERVED	594 - 603	Reserved	651	BACKUP AMP 1 TRIP
446	REMOTE DISPLAY 32 TROUBLE	547	RESERVED	604	DATABASE CORRUPTED	652	BACKUP AMP 2 TRIP
447	REMOTE DISPLAY 32 NO ANSWER	548	RESERVED	605	AUDIO LIBRARY CORRUPTED	653	BACKUP AMP 3 TRIP
448	SYSTEM INITIALIZATION	549	RESERVED	606	DATABASE INCOMPATIBLE	654	BACKUP AMP 4 TRIP
449-502	RESERVED	550	RESERVED	607	AUDIO LIBRARY INCOMPATIBLE	655	DSBUS 1 AC FAIL
503	SOFTWARE MISMATCH	551	RESERVED	608	DAA DOWNLOAD IN PROGRESS	656	DSBUS 2 AC FAIL
504	NO POWER SUPPLY INST	552	RESERVED	609	RESERVED	657	DSBUS 3 AC FAIL
505	LOOP 1-2 COMM FAILURE	553	RESERVED	610	RESERVED	658	DSBUS 4 AC FAIL
506	LOOP 3-4 COMM FAILURE	554	RESERVED	611	PHONE CHANNEL LIMIT EXCEEDED	659	DSBUS 1 HIGH BATT
507	LOOP 5-6 COMM FAILURE	555	RESERVED	612	NCM SNIFFER MODE ACTIVE	660	DSBUS 2 HIGH BATT
508	LOOP 7-8 COMM FAILURE	556	RESERVED	613	NCM CONNECTION LIMIT EXCEEDED	661	DSBUS 3 HIGH BATT
509	LOOP 9-10 COMM FAILURE	557	RESERVED	614	HARDWARE MISMATCH	662	DSBUS 4 HIGH BATT
510	TEST PROGRAM UPDATE	558	RESERVED	615	DAL DEVICE NO ANSWER	663	DSBUS 1 LOW BATT
511	RESERVED	559	RESERVED	616	PRIMARY AMP 1 HARDWARE FAILURE	664	DSBUS 2 LOW BATT
512	RESERVED	560	RESERVED	617	PRIMARY AMP 2 HARDWARE FAILURE	665	DSBUS 3 LOW BATT
513	RESERVED	561	RESERVED	618	PRIMARY AMP 3 HARDWARE FAILURE	666	DSBUS 4 LOW BATT
514	RESERVED	562	RESERVED	619	PRIMARY AMP 4 HARDWARE FAILURE	667	DSBUS 1 SELF TEST FAIL
515	RESERVED	563	RESERVED	620	BACKUP AMP 1 HARDWARE FAILURE	668	DSBUS 2 SELF TEST FAIL
516	RESERVED	564	RESERVED	621	BACKUP AMP 2 HARDWARE FAILURE	669	DSBUS 3 SELF TEST FAIL
517	RESERVED	565	RESERVED	622	BACKUP AMP 3 HARDWARE FAILURE	670	DSBUS 4 SELF TEST FAIL
518	RESERVED	566	RESERVED	623	BACKUP AMP 4 HARDWARE FAILURE	671	PRIMARY AMP 1 FAIL
519	RESERVED	567	RESERVED	624	DSBUS 1 COMMFAL	672	PRIMARY AMP 2 FAIL
520	RESERVED	568	RESERVED	625	DSBUS 2 COMMFAL	673	PRIMARY AMP 3 FAIL
521	RESERVED	569	RESERVED	626	DSBUS 3 COMMFAL	674	PRIMARY AMP 4 FAIL
522	RESERVED	570	RESERVED	627	DSBUS 4 COMMFAL	675	BACKUP AMP 1 FAIL
523	RESERVED	571	RESERVED	628	AA TROUBLE BUS FAIL	676	BACKUP AMP 2 FAIL
524	RESERVED	572	GROUND FAULT PORT A	629	NFN PAGING CHANNEL LIMIT EXCEEDED	677	BACKUP AMP 3 FAIL
525	RESERVED	573	GROUND FAULT PORT B	630	BACKUP AMP LIMIT	678	BACKUP AMP 4 FAIL
526	RESERVED	574	AMPLIFIER TROUBLE	631	PRIMARY AMP 1 LIMIT	679	BACKUP AMP NOT INSTALLED
527	RESERVED	575	AUXIN TROUBLE	632	PRIMARY AMP 2 LIMIT	680	BACKUP AMP 1 NOT INSTALLED
528	RESERVED	576	DIGIN TROUBLE	633	PRIMARY AMP 3 LIMIT	681	BACKUP AMP 2 NOT INSTALLED
529	RESERVED	577	FFT TROUBLE	634	PRIMARY AMP 4 LIMIT	682	BACKUP AMP 3 NOT INSTALLED
530	RESERVED	578	REMOTE MIC TROUBLE	635	BACKUP AMP 1 LIMIT	683	BACKUP AMP 4 NOT INSTALLED
531	RESERVED	579	DAP PORT A FAILURE	636	BACKUP AMP 2 LIMIT	684	MODBUS COMMUNICATIONS FAULT
532	RESERVED	580	DAP PORT B FAILURE	637	BACKUP AMP 3 LIMIT	685	VESDANET TROUBLE
533	RESERVED	581	DAA NO ANSWER	638	BACKUP AMP 4 LIMIT		
534	RESERVED	582	LOCAL MIC TROUBLE	639	PRIMARY AMP 1 OVERCURRENT		

Table H.1 System Trouble Names and Codes (2 of 2)

Table H.2 gives a description of each system trouble.

SYSTEM TROUBLES	
TROUBLE MESSAGE TYPE	TROUBLE DESCRIPTION
AA TROUBLE BUS FAIL	The AA Trouble Bus has failed to communicate with the fire panel. Check wiring and source.
AC FAIL	Loss of AC power to DAA. Investigate whether there is an AC power loss, or whether the DAA-PS is correctly installed and wired.
ADV WALK TEST	There is an Advanced Walk Test in progress.
AMPLIFIER LIMIT	A digital audio amplifier is overloaded. Remove outputs to lower the load on the speaker circuits. See the digital audio amplifier manual for more information.
AMPLIFIER SUPERVISION	The digital audio amplifier's internal supervision is not working. Call Technical Services.
AMPLIFIER TROUBLE	The DAA is in trouble. The output is overloaded or the amplifier is damaged. Remove outputs to determine if the DAA was overloaded. If it still does not work, call Technical Services.
ANALOG OUTPUT $\underline{x}$ TROUBLE	A trouble has occurred on DVC-AO analog output $\underline{x}$ (1 - 4). The analog output is configured for Style 7, but no audio signal is returned. Investigate and fix.
ANNUN $\underline{x}$ NO ANSWER	The annunciator at address $\underline{x}$ is not responding.
ANNUN $\underline{x}$ TROUBLE	The annunciator at address $\underline{x}$ is in trouble.
AUDIO LIBRARY CORRUPTED	The DVC's audio library is corrupted. Re-create and/or re-download an intact database.
AUDIO LIBRARY INCOMPATIBLE	The version is incompatible with the database and/or the application version.
AUXILIARY TROUBLE	Auxiliary device connected to the CPU2-3030 at J5 is in trouble or the cable is missing.
AUXIN TROUBLE	Generated when the auxiliary input is supervised (as determined in VeriFire™ Tools programming) and no signal is coming from the input. Check wiring and source.
BACKUP AMP $\underline{x}$ FAIL	The Backup Amp at address $\underline{x}$ has failed. Call Technical Services.
BACKUP AMP $\underline{x}$ HARDWARE FAIL	The Backup Amp at address $\underline{x}$ has had a hardware failure. Call Technical Services.
BACKUP AMP $\underline{x}$ LIMIT	The Audio Circuit of the Backup Amplifier at address $\underline{x}$ has been overloaded or shorted so the Audio Signal has been attenuated. Check wiring and source and ensure that there are no shorts.
BACKUP AMP $\underline{x}$ OVERCURRENT	The Backup Amplifier at address $\underline{x}$ has overloaded and shut down. Check the total Load calculations for the DS-AMP and/or DS-BDA and ensure the total values do not exceed 120 watts.
BACKUP AMP $\underline{x}$ NOT INSTALLED	The Backup Amplifier that is programmed at address $\underline{x}$ is not communicating with the DS-AMP. Ensure the ribbon and power cables are properly attached to the DS-AMP and DS-BDA. If there is no Backup Amplifier at that address, remove the Backup Amplifier from programming.
BACKUP AMP $\underline{x}$ TRIP	The DS-BDA at DS-BUS address $\underline{x}$ (1-4) is drawing more current from the power supply than expected and has been disabled. Refer to the DVC manual for additional troubleshooting.
BASIC WALK TEST	A Basic Walk Test is in progress.
BATTERY	The power supply's battery voltage is too high or too low. Check the batteries for problems. Replace batteries if necessary.
BUZZER OFF-LINE	The piezo is disabled.
CHARGER FAIL	The DAA's battery charger is not functioning. Investigate and correct.
CORRUPT LOGIC EQUAT	The database that houses the panel's logic equations is corrupt. It must be re-downloaded, or all programming must be cleared and re-entered.
DAA ADDRESS CONFLICT	More than one DAA has the same address.
DAA DOWNLOAD IN PROGRESS	The DVC is currently downloading to DAAs.
DAA NO ANSWER	A DAA is not responding. Investigate and fix.
DAL DEVICE NO ANSWER	The DAL device is no longer communicating with the fire panel. Check wiring and source
DAP PORT $\underline{x}$ FAILURE	Digital Audio Port $\underline{x}$ (A or B) is not communicating due to a break in the connection, a short, or faulty hardware. Locate and fix the break or short. If the problem is not a short or break, call Technical Services.
DATABASE CORRUPTED	The DVC programming database is corrupt. Re-create and/or re-download the database.
DATABASE INCOMPATIBLE	The DVC programming database version is incompatible with DVC software.
DIGIN TROUBLE	The DAA has determined that its DVC has stopped transmitting audio data to the Digital Audio Loop (DAL), even though the loop is still functional. Update code, ensure all code on the DAL is compatible. If the DVC still does not transmit digital audio data, call Technical Services.
DISPLAY NODE LIMIT EXCEEDED	The number of display nodes on the network has been exceeded. This trouble will only be displayed if at least one of the NFS2-3030s on the network are in Network Display Mode and the total number of display nodes has exceeded 25. Remove one or more display nodes to correct this trouble. (Display nodes include NCA, NCA-2, a Gateway node, or an NFS2-3030 in Network Display Mode.)
DRILL INITIATED	Drill has been initiated locally.
DRILL RECEIVED	Drill has been initiated remotely.

**Table H.2 System Trouble Descriptions (1 of 3)**

SYSTEM TROUBLES	
TROUBLE MESSAGE TYPE	TROUBLE DESCRIPTION
DSBUS <u>x</u> AC FAIL	The DSBUS at address <u>x</u> has lost AC power. Check wiring and source.
DSBUS <u>x</u> COMMFAIL	The DSBUS at address <u>x</u> is not communicating with the fire panel. Check wiring and source.
DSBUS <u>x</u> HIGH BATT	The battery voltage for the DSBUS at address <u>x</u> has exceeded 28 V. If the batteries are shared, ensure that only one power supply is charging the batteries. Remove the batteries and measure the charging voltage from the supply to ensure it is not exceeding 27.6 V. Call Technical Services.
DSBUS <u>x</u> LOW BATT	The battery voltage for the DSBUS at address <u>x</u> has fallen below 20.4 V. Charge or replace batteries.
DSBUS <u>x</u> SELF TEST FAIL	A device on the DSBUS at address <u>X</u> has failed self test. Reboot the device. If this does not repair it, update the software of the device. If the self test fail trouble continues to be displayed, call Technical Services.
EPROM ERROR	The application and/or boot code is corrupt. Service required.
EXTERNAL RAM ERROR	The external RAM test failed. Service required.
FLASH IMAGE ERROR	The software is corrupt. Re-download the panel code software from VeriFire™ Tools. If the trouble does not clear, call Technical Services.
FFT TROUBLE	There is a short or open on an FFT riser on a Digital Audio Loop. Check that the DVC's 4-wire switch is set properly and that there is an end-of-line resistor in place for 2-wire operation.
GROUND FAULT	A ground fault has occurred within the panel.
GROUND FAULT LOOP <u>x</u>	There is a ground fault on loop <u>x</u> .
GROUND FAULT PORT <u>x</u>	A ground fault has occurred on DAP <u>x</u> (A or B).
HARDWARE MISMATCH	The device installed does not match what was previously installed. Install the correct device.
INTERNAL RAM ERROR	The internal RAM test failed. Service required.
INVALID NODE TYPE MAPPED	An invalid node type has been mapped to the NFS2-3030 for Network Display Mode. Check network mapping and correct. Refer to "Limitations" on page 168 for valid network types.
INTERNAL RAM ERROR	The internal RAM test failed. Service required.
LCD80 SUPERVISORY	Communication has been lost with an LCD-80.
LOADING..NO SERVICE	A program or database download is in progress. The panel is NOT providing fire protection during the download. Proper authorities should be notified while a download is in progress so that other means of fire protection can be supplied.
LOCAL MIC TROUBLE	The DVCs local microphone is in trouble. There is no communication, or paging has been enabled for over 28 seconds and no signal has been received. Investigate whether the mic is plugged into the DVC, or whether there is a problem with the local mic.
LOCAL PHONE TROUBLE	The DVC's local FFT handset is in trouble. There is no communication, or paging has been enabled for over 28 seconds and no signal has been received. Investigate whether the handset is plugged into the DVC, or whether there is a problem with the handset.
LOOP <u>x</u> - <u>x</u> COMM FAILURE	Loops <u>x</u> and <u>x</u> are not responding. The LCM and LEM for those loops must be serviced.
MAN EVAC INITIATED	Local initiation of DRILL
MAN EVAC RECEIVED	Network initiation of DRILL
MANUAL MODE ENTERED	An annunciator has been placed in manual mode.
MODBUS COMMUNICATIONS FAULT	The VESDA® Gateway can not communicate with the HLI, HLI may be damaged or not powered, or the VESDA Gateway may be damaged.
NCM COMM LOSS	Communication lost between CPU2-3030 or DVC and network communications module.
NCM CONNECTION LIMIT EXCEEDED	More than two panels have been connected to a high-speed network communications module.
NCM SNIFFER MODE ACTIVE	The network is in a diagnostic state.
NETWORK FAIL PORT <u>x</u>	Communication lost between NCM Port <u>x</u> and corresponding node.
NETWORK INCOMPATIBILITY	The brand of this panel is incompatible with this network.
NETWORK MAPPING LIMIT EXCEEDED	More than 1 fire panel or more than 4 DVCs has been mapped to the NFS2-3030 for Network Display Mode. Check network mapping and correct.
NFN PAGING CHANNEL LIMIT EXCEEDED	Multiple paging sources are attempting to page over the NFN, exceeding the limit of one (1). reduce the number of paging sources to clear this trouble.
NFPA 24HR REMINDER	This message occurs every day at 11 am if any troubles exist.
NVRAM BATT TROUBLE	Battery backup and/or clock backup is low. Replace battery.
NO DEV. INST ON L1	No devices are installed on the system.
NO POWER SUPPLY INST	The address of the main power supply has not been entered.
PANEL DOOR OPEN	The panel door is open.
PHONE CHANNEL LIMIT EXCEEDED	The DVC has allocated all its phone channels, and there are still phones ringing in requesting more channels.
POWER SUPPLY TROUBLE	There is a communication failure with the DAA onboard power supply. Call Technical Services.

Table H.2 System Trouble Descriptions (2 of 3)

SYSTEM TROUBLES	
TROUBLE MESSAGE TYPE	TROUBLE DESCRIPTION
PRIMARY AMP $\underline{x}$ FAIL	The Primary Amp at address $\underline{x}$ has failed. Call Technical Services.
PRIMARY AMP $\underline{x}$ HARDWARE FAIL	The Primary Amp at address $\underline{x}$ has had a hardware failure. Call Technical Services.
PRIMARY AMP $\underline{x}$ LIMIT	The Audio Circuit of the Primary Amplifier at address $\underline{x}$ has been overloaded or shorted so the Audio Signal has been attenuated. Check wiring and source and ensure that there are no shorts.
PRIMARY AMP $\underline{x}$ OVERCURRENT	The Primary Amplifier at address $\underline{x}$ has overloaded and shut down. Check the total Load calculations for the DS-AMP and/or DS-BDA and ensure the total values do not exceed 120 watts.
PRIMARY AMP $\underline{x}$ TRIP	The DS-BDA at DS-BUS address $\underline{x}$ (1-4) is drawing more current from the power supply than expected and has been disabled. Refer to the DVC manual for additional troubleshooting.
PRINTER OFF LINE	Communication loss with printer. Restore power and/or printer's online status.
PRINTER PAPER OUT	Add paper.
PROGRAM CORRUPTED	The database that houses the panel's programming is corrupt. It must be re-downloaded, or all programming must be cleared and re-entered. Service required.
PROG MODE ACTIVATED	A user is currently using the panel's programming menus.
REMOTE DISPLAY $\underline{x}$ NO ANSWER	The remote display at address $\underline{x}$ is not responding.
REMOTE DISPLAY $\underline{x}$ TROUBLE	The remote display at address $\underline{x}$ is in trouble.
REMOTE MIC TROUBLE	The DVC's remote microphone is in trouble. It is installed and supervised, but no signal is coming from it. Investigate and fix.
SELF TEST FAILED	Diagnostic test failed. Service required. Call Technical Services.
SOFTWARE MISMATCH	One or more LCM or DAA software revisions do not match other LCMs or DAAs, and/or the network communications module is not network version 5.0, or LCD-160 software is incompatible. Update the software as necessary.
STYLE 4 SHORT $\underline{x}$ LOOP $\underline{x}$	Service required. Call Technical Services.
STYLE 6 POS. LOOP $\underline{x}$	There is an open circuit on the positive side of loop $\underline{x}$ . Style 6 and Style 7 are supervised methods of communicating with addressable devices. If the control panel detects a trouble (open only), it will drive both ends of the loop, maintaining communication in an unsupervised method. The latching trouble will display on the panel as a Style 6 trouble until you correct the condition and press reset. Style 7 configuration of the SLC requires the use of ISO-X modules.
STYLE 6 NEG. LOOP $\underline{x}$	There is an open circuit on the negative side of loop $\underline{x}$ . Style 6 and Style 7 are supervised methods of communicating with addressable devices. If the control panel detects a trouble (open only), it will drive both ends of the loop, maintaining communication in an unsupervised method. The latching trouble will display on the panel as a Style 6 trouble until you correct the condition and press reset. Style 7 configuration of the SLC requires the use of ISO-X modules.
STYLE 6 SHORT LOOP $\underline{x}$	Style 6 and Style 7 are supervised methods of communicating with addressable devices. If the control panel detects a trouble (open or short), it will drive both ends of the loop, maintaining communication in an unsupervised method. The latching trouble will display on the panel as a Style 6 trouble until you correct the condition and press reset. Style 7 configuration of the SLC requires the use of ISO-X modules.
SYSTEM INITIALIZATION	One or more devices (detectors or modules) can not report activation. This can occur following system startup, when exiting Walk Test, or following a device trouble of No Response.
VESDA TROUBLE	A trouble has occurred on a VESDA node. Possible troubles may include: Communication failure on the VESDA detector loop, incompatible VESDA software versions, or VESDA configuration error.

Table H.2 System Trouble Descriptions (3 of 3)

# Appendix I: Regional Settings

The panel programming REGIONAL SETTINGS choices, available through the Panel Settings (2) screen (refer to page 22) are described below. The REGIONAL SETTINGS screen (Refer to Figure I.1) allows scrolling through the available choices by pressing the soft key. Choices are CHICAGO, SINGAPORE, AUSTRALIA, CHINA or DEFAULT (no special regional settings).

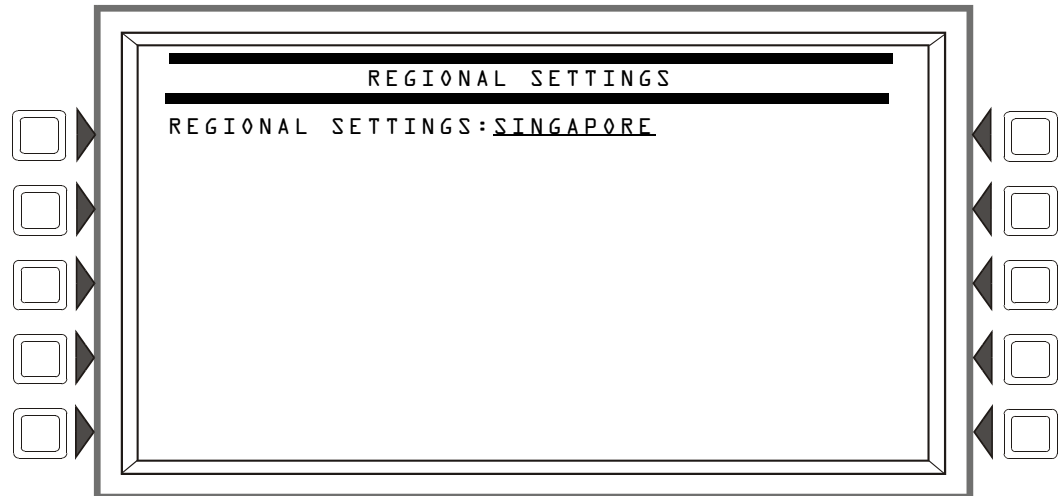
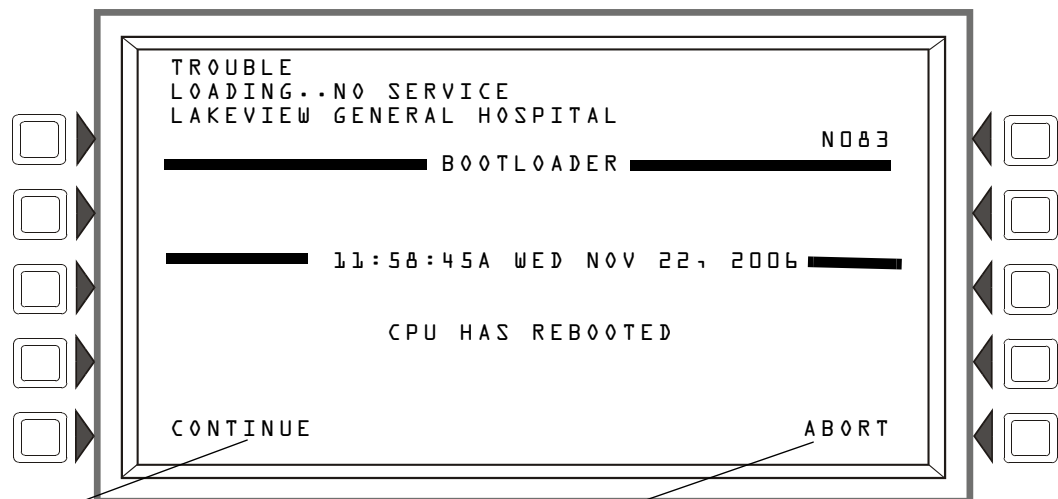


Figure I.1 Regional Settings Screen

## I.1 Singapore

The REGIONAL SETTING choice of SINGAPORE activates the following features:

- Does not allow the disabling of a bell circuit either locally or via the network.
- A BELL CIRCUIT Type Code will allow power monitoring.
- The panel will sound the piezo when local control is set to OFF.
- Does not turn ON the System Trouble LED or the System Trouble relay for disabled points.
- Does not turn ON the System Trouble LED, the System Trouble relay, or the piezo when Drill is initiated.
- Turns ON keypad LEDs, PCB LEDs, and all ACM-24/48 LEDs during Lamp Test.
- Requires the user to initiate the start of the application when the panel boots/reboots. The CPU Failure LED will be ON until the user initiates startup. (Refer to Figure I.2.)



User should select CONTINUE to initiate applications.

User should select ABORT to abort applications.

Figure I.2 Singapore Application Initiation

## I.2 Chicago

The REGIONAL SETTING choice of CHICAGO disallows local drill or signal silence.

- The DRILL and SIGNAL SILENCE keys at the panel will not function.
- Annunciator Control Modules and SLC modules given a drill or signal silence Mode or Type Code will not allow local drill or signal silence initiation.
- Events must be acknowledged prior to system reset.

## I.3 Australia

The REGIONAL SETTING choice of AUSTRALIA activates the following features:

- allows use of the Australian smoke control module SCS-8AU.
- “Brigade Act” LED is controlled by ZL1000.
- Test LED is lit during walktest.
- Ability to manually corrupt memory to test memory corruption detection. Special passwords for testing memory corruption detection.
  - “corrupta” will temporarily corrupt a location in the application.
  - “corruptb” will temporarily corrupt a location in the boot.
  - “corruptd” will temporarily corrupt a location in the database.
  - “reset” will uncorrupt the panel and reboot.
- Plant Isolate button will disable/enable ZL999. Use special function zone ZF6 with ZL999.
- No softkeys on the panel will function while there is an unacknowledged alarm *EXCEPT* scroll, silence, reset and disable.
- Silence Buzzer key acknowledges everything before silencing.
- Special Function Zone ZF17 may be used with Signal Silence. When a Signal Silence is performed, ZF17 will go active and remain active until a System Reset is performed.
- Disable key disables the current event on the screen.
- Special Function Zone ZF7 may be used for Drill. When the drill key is pushed or a drill performed, ZF7 will go to active. When the system reset key is pushed or a system reset is performed, ZF7 will go normal.
- Fan control function per AS/NZS 1668:1:1998, section 4.13.2.
- First zone in alarm displayed at top of display. Additional zones in alarm also displayed, until panel reset. Alarm zones not currently on display may be viewed using the scroll button.
- Security events will light the supervisory LED. The supervisory scroll key will scroll through security events.
- Display acknowledged and unacknowledged alarms at the same priority.
- Pre-alarm events will be displayed after alarms.
- The Main Menu includes an “Other events” menu key to scroll through other events.
- Password Bypass Timer enabled. After entering a valid password, the user does not need to enter a password again until no key is pressed for ten minutes.
- Active Output events are displayed if Output Activations are enabled in the Event Logging menu.
- Disable/Enable button will disable or enable the currently-displayed event.
- AMPS-24 supervision disabled.
- When the primary supply is not an AMPS-24, selecting AUX trouble supervisory setting will generate a general power supply fault.

## I.4 China

The REGIONAL SETTING choice of CHINA activates the following features:

- POM-8A support.
- Active output events displayed. A counter is displayed for active outputs.
- Municipal Communication panel settings.
- New special function zone for alarm verification.
- Prealarm automatically cleared after five minutes.
- Co-op detectors alarm functions
- Dual alarm window.
- Points in trouble will not activate.
- Ten minute limit for DEL and SDEL delay functions.
- Disable events do not light LED or trip the trouble relay.
- No system trouble generated upon entering program mode.
- Low AC operation of FACP.
- Power supply troubles.
- Ability to manually corrupt memory to test memory corruption detection.

# Appendix J: Network Display Mode

The panel programming NETWORK DISPLAY MODE choices, available through the Panel Settings (3) screen (refer to page 25) are described below. Network Display Mode allows the NFS2-3030 to display network events for mapped nodes. This feature is programmable via the NFS2-3030 or through VeriFire Tools.

## J.1 Limitations

When in Network Display Mode:

1. Only the following network node types can be mapped to the NFS2-3030:
  - NFS2-3030
  - NFS2-640
  - NFS-320
  - DVC
  - NFS-640
  - NFS-3030
2. Read Status, Control On/Off, Disable/Enable, and Network Control-By-Event will only function for the nodes that are mapped to the NFS2-3030.
3. The number of display type nodes for the entire network is limited to a total of 25. Display nodes include NCA, NCA-2, a Gateway node, or an NFS2-3030 in Network Display Mode.

## J.2 Event, Mass Notification, and Drill Mapping

The NFS2-3030 can be programmed to monitor events and initiate drill on one (1) additional fire panel and up to four (4) DVCs. For information on Network Node Mapping, refer to “Network Mapping” on page 20.

Mapping a network node to the NFS2-3030 on the Network Mapping menu will allow the NFS2-3030 to monitor and annunciate events for that node. Mass Notification and Drill Mapping for the NFS2-3030 can only be changed through VeriFire Tools. Refer to the *VeriFire Tools Help File*.

## J.3 Panel Control Functions

### Acknowledge, System Reset, Signal Silence and Drill

In Network Display Mode, the NFS2-3030 has the ability to perform a network Acknowledge, System Reset, Signal Silence and Drill. Only the network nodes mapped to the NFS2-3030 will be affected.

### Auto Silence

In Network Display Mode, the Auto Silence feature also applies to any network nodes mapped to the NFS2-3030.



---

**NOTE:** Initiating an Acknowledge, System Reset, Signal Silence or Drill on a network node mapped to the NFS2-3030 may affect nodes that are not participating in Network Display Mode through Logic Zone Programming.

---

### J.3.1 Print Functions

When in Network Display Mode, printing active points on the NFS2-3030 will also display any active points of any mapped network nodes.



## Notes

# Glossary

This section contains descriptions of terms essential to know when programming the control panel.

**Alarm History** See History buffer.

**Alarm Verification Timer** A user-defined global software timer function that can reduce the number of nuisance alarms. When you select Alarm Verification for a detector, the control panel delays an alarm signal for a user-specified time period. (The control panel ignores the Alarm Verification Timer if it detects another alarm during the verification period.)

**Argument** An argument is a discrete part of a logic function used in a CBE logic or trouble equation. It can consist of panel/SLC addresses for detectors, modules, zones, special function zones, logic or trouble equations.

**Auto Silence Timer** A user-defined global software timer that functions like pressing the signal silence key. The control panel silences all active outputs programmed as silenceable once the timer has reached the selected time. For example, if 20 minutes is selected, when the timer reaches 20 minutes the control panel turns off all active outputs programmed as silenceable.

**Autoprogram** A software routine that directs the control panel to identify and automatically load SLC-connected devices into the program with default values for all parameters. The Autoprogram Finds and displays all new or missing intelligent detectors and modules--while ignoring devices already installed in memory--so you can edit default option selections. Typically, you Autoprogram the control panel as a first step in a new installation, or to add devices.

**Control module** An addressable module that a) switches power to a Style Y or Style Z NAC; or b) functions as a Form-C control relay.

**CBE (Control-by-Event)** A programming method that lets you map inputs and outputs to provide a variety of output responses based on various initiating conditions (events).

**CLIP poll** - Classic Loop Interface Protocol - CLIP - is standard polling of each intelligent device (as differentiated from FlashScan poll, a method of group polling described below).

**DCC (Display and Control Center)** - Term for a display location, programmed to participate in DCC, when it has control of Acknowledge, Signal Silence, System Reset and Drill functions.

**Drift Compensation** An algorithm which permits the maintenance of a constant smoke detector sensitivity by accounting for environmental contaminants and other factors.

**Download** A function for loading a system program from a file on a personal computer and storing the program in system memory of the control panel. Also see Veri•Fire.

**FlashScan poll** - a patented system (US Patent Number 5,539,389) that enhances the speed of communication between analog intelligent devices. Communication is in a grouped fashion. When one of the devices within the group has new information, the panel CPU stops the group poll and concentrates on single points.

**History buffer** The control panel maintains a history buffer of the last 4000 events, each with a time and date stamp. History events include all alarms, troubles, operator actions, and programming entries. The control panel also maintains a 1000-event Alarm History buffer, which consists of the 1000 most recent alarm events from the 4000-event history buffer.

**latching** An attribute of a device that keeps it in an active state until the condition causing the activation is corrected and the panel is reset.

**Missing device** A device that exists in a program, but is not found by the control panel during Autoprogram, typically because the device is disconnected.

**NAC (Notification Appliance Circuit)** A circuit or path directly connected to a notification appliance device (a fire alarm system component--such as a bell, speaker, strobe, and so on--that produces an audible output, a visual output, or both). On this panel, NACs can be transponder points or control modules.

**New device** A device connected to the control panel, but not in program memory.

**Non-latching** An attribute of a device that follows the state of the fire alarm system. That is, if a device is non-latching, it returns to its normal state automatically when the condition clears.

**Notification Appliance Circuit** see NAC.

**Obscuration** A reduction in the atmospheric transparency caused by smoke, usually expressed in percent per foot.

**Output circuit** A control module connected to the SLC.

**Point** A system memory address occupied by an addressable SLC device, Software Zone, or annunciator. For example, the control panel considers “L01M102”, a module on loop 1 at address 102, as a point.

**Panel sounder** The piezo sounder on control panel, that pulses when troubles and alarms occur.

**Primary zone** The zone in the first position of a point’s zone map. The FACP looks at this zone for certain functions, such as some Cross Zone activations or Walk Test participation.

**Silence Inhibit Timer** A user-defined timer that disables the signal silence key function for the programmed time (0-300 seconds) when a fire alarm occurs. All subsequent alarms can be silenced immediately.

**SLC (Signaling Line Circuit)** A physical wire loop used to connect addressable detectors and modules to the control panel.

**General Zone** A label, internal to the fire alarm system, assigned to a group of addressable devices.

**Switch Inhibit** A software function that allows the programming of control modules and NACs so an operator cannot manually activate NACs. With Switch Inhibit enabled, an operator cannot manually activate the NACs from the control panel.

**System Normal message** A message that displays on the second line of the LCD display during normal operation of the control panel.

**System Reset** Pressing the System Reset fixed function key will clear all latched alarms and other events if the initiating condition is gone. LEDs associated with these events will turn off. Unacknowledged events will not prevent reset from functioning. If alarms or other off-normal events exist after reset, they will resound the system. The System Reset key will not function if the programmable Silence Inhibit timer is running. If multiple

The System Reset key will not immediately silence active outputs. If the Control-by-event programming for the output evaluates false after reset, the output will deactivate. (Typically this is 30 seconds local, 60 seconds network.)

**Terminal Interface** EIA-232 bidirectional serial port used for upload and download functions.

**Tracking** An attribute of a device that allows it to enter an active state when a condition causes its activation, then to return from an active to an inactive state when the condition causing its activation is corrected.

**Type Code** A Type Code is a software function that specifies the function of a detector, control module, monitor module, transponder point, or NAC. (You can select a Type Code while programming a point). The Type Code specifies what action the control panel takes when the point activates. For example, when a monitor module with evacuate as a Type Code activates, the control panel activates all outputs, as if someone pressed the drill key.

**Upload** A function for making a copy of a system program and storing the program as a file on a personal computer. Also see VeriFire™ Tools Programming Utility.

**View (Very Intelligent Early Warning) System** A smoke detection system, consisting of the NFS2-3030 control panel and intelligent laser detectors, that provides very early warning of smoldering fires.

**VeriFire™ Tools Program Utility** A software utility for uploading and downloading a system program between a personal computer and the control panel through the EIA-232 port.

**Walk Test** A feature that lets a single (qualified) maintenance person test a fire alarm control panel and initiating devices without causing the control panel to enter into an alarm state.

**Zone Map** SLC inputs (detectors and monitor modules) and outputs (control modules) provide for up to ten zone selections for CBE.

# Index

## A

- Abort Switch **109**
    - AHJ **115**
    - Basic configuration example **110**
    - Configuration example with monitor module **118**
    - IRI **112**
    - NYC **113**
    - To program **118**
    - Type Code (ULI, IRI, NYC, AHJ) **62, 108**
    - ULI **111**
  - AC Fail Delay **29**
  - ACCEPT soft key, about **12**
  - Acclimate, detector sensitivity settings **139**
  - Acknowledge
    - AKS-1 **39**
    - Local control **21**
  - ACPS-2406 **30**
  - ACPS-610 **30**
  - ACS
    - Annunciation, releasing applications **129**
    - Number of annunciator devices per circuit **32**
    - Point Programming **34**
    - Programming
      - Mode **34**
      - Point **34**
      - Source **36**
    - Smoke control devices **32**
    - TM-4 **32**
    - Trouble Reporting Delay **67**
    - Type **33**
    - UDACT **32**
    - UDACT-2 **32**
    - UZC Zone Coder **32**
  - Action level, prealarm **138**
  - Address
    - To display **22**
  - Advanced Warning Addressable Combustion Sensing *see* Intelligent Sensing Applications
  - AHJ Abort Switch **115**
  - AKS-1 keyswitch, functions **39**
  - Alarm Sensitivity
    - Levels **136**
      - Alarm, to set **51**
      - Prealarm, to set **51**
    - Table, displayed on screen **51**
    - To select **81, 138**
  - Alarm Verification **29, 50, 56, 170**
  - Alert Level, pre-alarm **137**
  - ALL CALL **35**
  - Alter Status **77–92**
    - Clear History **82**
    - Alarm, Event or All History **83**
    - Clear Verify Counters **82**
    - Control On/Off **91**
      - Force On/Off **92**
      - Point select **91**
    - Detector Alarm Sensitivity **80**
      - Occupied & Unoccupied Alarm & Prealarm Sensitivity **81**
      - Point Select **80**
    - Disable/Enable **79**
    - Mesh Formation **94**
    - Point selection for disable/enable **78, 95, 96**
    - Program Time/Date **90**
    - Shutdown Wireless Devices **95**
    - Switch Disable **94**
    - Walk Test
      - Advanced **84**
      - Audible **84**
      - Disable ACS Boards **86**
      - Panel test screen **89**
      - Parameter **85**
      - Wireless Programming **93**
  - AMG **12, 33**
  - AMPS-24 **30**
  - Annunciator
    - Address format **47**
  - Annunciator, *See* ACS **33**
  - Application Corrupt Screen **102**
  - Argument **148, 170**
  - Arrow keys **11**
  - Audio Volume Control **69**
    - auto program **20**
  - Auto Silence **30, 170**
  - Autoprogram **71–76, 170**
  - Auxiliary Control Functions, releasing applications **129**
  - Auxiliary trouble reporting **38**
  - AWACS *see* Intelligent Sensing Applications
- ## B
- BACK soft key, about **11**
  - Beam detector sensitivity settings **52, 139**
  - Blink Mode **43**
  - Bootloader Screen **100**
- ## C
- Canada
    - Auto Silence Value **30**
    - Event ordering **21**
    - ULC installation Alarm Verification timer value **29, 67**

- Canada Event Order **22**
  - CAUTION
    - Do not mix general zones with other sources... **37**
    - Mapping of inputs not associated with Primary Zones **116**
    - On systems utilizing the DCC function... **23**
  - CBE (Control-by-Event) **146, 170**
  - CCBE (Cooperative Control-By-Event) **146**
  - Channel A,B thresholds **19**
  - Clear
    - ACS programming **70**
    - All programming **70**
    - History **82**
    - Loop programming **70**
    - Panel programming **70**
    - Verify Counters **82**
  - CLIP Mode **43**
  - Communication loss, panel & SLC **50**
  - Control Module **170**
    - See Module, SLC
  - Control On/Off **91**
  - Cooperative Multi-Detector Sensing **50, 137**
  - CPU2-3030 **38**
  - Cross Zone **108**
    - Programming example **116**
    - To activate a Releasing Zone **116**
    - Types **116, 117**
  - CRT Supervision **38**
  - Custom Action message
    - Detector **50, 51**
    - Module **56**
    - To create **44**
    - To view **44**
    - To view, point **51**
  - Custom Drill Mode **131**
  - Custom Tone Setup **26**
- D**
- DAA-5025/DAA-5070 **69**
    - Address format **47**
  - DCC Participation **23**
  - Default settings soft key **23**
  - Default Timers soft key **31**
  - Delay Time **108**
  - Delete point **70**
  - Delete Program **69**
    - Clear
      - ACS programming **70**
      - All programming **70**
      - Loop programming **70**
      - Panel **70**
    - Delete point **70**
  - Delete Program Menu, when programming panel the first time **17**
- Detector
- Address format **46**
  - Alarm Sensitivity Levels **51, 80, 136**
  - Alarm Verification **50**
  - Custom action message **50**
  - Drift Compensation **134**
  - Extended label **48**
  - FlashScan code label **47**
  - Label **47**
  - Local Mode **50**
  - Maintenance Level messages **135**
  - Maintenance Warning **135**
  - Multi-Detector (Coop) **50**
  - Occupancy Schedule **52**
  - Point programming **47**
  - Poll **43**
  - Pre-Alarm Sensitivity Level **136**
  - Print a Detector Maintenance Report **141**
  - Sensitivity **50**
  - To replace **153**
  - To test detectors set below 0.50% obscuration per foot **140**
  - Type Codes **47**
  - Weekly Occupancy Schedule **52**
  - Zone map **48**
- Disable/Enable Point Selection **78**
- Displayless Mode
  - Service-level switches, ACK, SIG-SIL, SYSRST, LAMP **11**
- Do not assign Releasing Type Codes to Panel Circuits **157**
- Download **170**
- Download screen **102**
- Drift Compensation **134, 170**
  - Graphic representation **135**
- Drill
  - AKS-1 **39**
  - Local control **21**
- Drill Mode **25, 131**
- Drill Zone **131**
- DVC/DAA
  - Address format **47**
- DVC/DVC-EM **69**
- E**
- Equations
  - Arguments **148**
  - Editing **63**
  - Logic **147**
    - Functions **148**
  - Time-based functions **150**
  - Trouble **152**
- Event Counts Display **15**
- Event logging **45**
- Event ordering
  - Canada Event Order **21**

USA Event Order **21**  
 Extended label **48, 55**

## F

FAAST Detector  
     Reset Baseline **96**  
     Service Mode **95**  
 Factory default settings  
     Password **12**  
 FCM-1-REL releasing module **62**  
 Field information, how to enter **11**  
 Fixed position, detector zone map **49**  
 FlashScan code label **47, 55**  
 Force On/Off (point) **92**  
 FSC-851 detector sensitivity settings **139**  
 FST-751 **136**  
 FZM-1  
     & alarm verification **56**

## G

General Zone **61, 171**  
     Address format **46**  
 Group Zone Disable **79**

## H

Heat (Adjustable Threshold), detector sensitivity settings **139**  
 History buffer **170**  
 History Display **15**  
 Holiday menu **45**

## I

Initial programming  
     Basic procedure **12**  
 Initiating Devices for releasing zones **128**  
 Insert (Logic equation screen) **64**  
 Instant Release Circuit  
     Control module configuration example **127**  
     To program **127**  
 Intelligent Sensing Applications **134–144**  
     Cooperative Multi-Detector Sensing **137**  
     Detector Sensitivity **136**  
     Drift Compensation **134**  
     Features **134**  
     Maintenance Warnings, 3 levels **135**  
     Self-Optimizing Prealarm **136**  
     Smoothing **134**  
 Intelliquad detector sensitivity settings **139**  
 Ion detector sensitivity settings **139**  
 IP Access **19**  
 IRI Abort Switch **112**  
 ISO-X module **164**

## L

Label, point **47, 55**  
 Language selection **31**  
     LCD-160 **101**  
 latching **170**  
 LCD Programming **31**  
 LCD programming  
     Backlight **32**  
     Current setting **32**  
     Factory default setting **32**  
     Intensity down **31**  
     Intensity up **31**  
     Language **31**  
 LCD-160 Download Menu  
     Address **100**  
     Language **101**  
 LCD-80 **39**  
 LCM Download Menu **101**  
 LCM Local Mode, See Local mode **22**  
 Local control **21**  
 Local mode **22, 50, 57, 60**  
 Local Receive mode **21**  
 Logic equations, editing **63**  
 Logic Zone **62, 146**  
     Address format **47**  
 Loop Download Menu  
     Download Type **101**  
     Loop Address **101**  
 Loop programming **43**  
     CLIP **43**  
     Configuration **42**  
     Detector poll **43**  
     FlashScan **43**  
     Module poll **43**  
     Rapid poll **43**  
     Wiring style **43**

## M

Main Menu **11, 15**  
 Main Power Supply Address **38**  
 Maintenance Warnings **135**  
 Major changes and additions  
     Basic procedure **12**  
 Manual Release Delay Switch  
     Monitor module configuration example **120**  
     To program **120**  
 Manual Release Switch  
     Monitor module configuration example **119**  
     To program **119**  
 Mass Notification  
     Fire Priority **27**  
     ZF20, ZF21, ZF22 **132**  
 Master password, see Password **13**  
 Maximum verification count **29**

- Menu Hierarchy **103**
- Mesh Formation **94**
- MN Control **27**
- Module
  - Address format **46**
- Module poll **43**
- Module, SLC
  - Control **59**
    - Custom action message **56**
    - Local mode **60**
    - Silenceable **60**
    - Switch inhibit **60**
    - Walk test **60**
    - Zone map **60**
  - Extended label **55**
  - FlashScan Code label **55**
  - Label **55**
  - Module Type (Control/Monitor) **55**
  - Monitor **56, 59**
    - Alarm verification **56**
    - FMM-4-20 **57**
    - Local control **57**
    - Zone map **56**
  - Type Codes **55**
- Monitor Module, see Module, SLC
- Multiple Event List **15**
- Multiple Events List screen
  - order of events **21**

**N**

- NAC (Notification Appliance Circuit) **170**
- Navigating Menu and Programming Screens **11**
- NBG-12LRA **109, 118, 119, 120, 121**
- Network Display Mode **168**
- network mapping **20**
- Network Parameters **18**
  - Channel threshold **19**
- Node
  - Label **19**
  - Number, range **19**
  - Standalone **19**
  - To view **19**
- Wiring style **19**
- NFPA Standards for Releasing Applications **109**
- NFS2-3030
  - Displayless Mode **11**
  - Two basic configurations **11**
- Node label **19**
- Node number **19**
  - For standalone panel **19**
  - Range **19**
  - To view **19**
- Non-fire activations
  - Event logging **45**
- Non-latching **171**
- Note

- Clearing all programs is not necessary when... (VeriFire) **17**
- NYC Abort Switch **113**

**O**

- Obscuration **171**
- Occupancy Schedule **40, 52**
  - Holidays **45**
- Output activations
  - Event logging **45**
- Output circuit **171**
- Overwrite (logic equation screen) **64**

**P**

- Panel programming, see Programming, Panel settings
- Panel settings **21**
  - AC Fail Delay **29**
  - Alarm Verification timer **29**
  - Auto Silence **30**
  - Auxiliary trouble reporting **38**
  - Custom Action message **44**
  - Default Settings **23**
  - Default Timers **31**
  - Display Address **22**
  - Event logging **45**
  - Event Ordering **21**
  - Holiday menu **45**
  - Local Control **21**
  - Local mode **22**
  - Local Receive mode **21**
  - Loop configuration **42**
  - Loop programming **43**
  - Maximum verification count **29**
  - PAS **30**
  - Password **40**
  - Piezo **21**
  - Poll types **43**
  - Presignal delay **31**
  - Proprietary Supervising Station **21**
  - Reminder Menu **22, 28**
  - Remote Display Menu **41**
  - Silence Inhibit **30**
  - Supervision **38**
    - CRT **38**
    - Main power supply address **38**
    - Printer **38**
  - Tamper input **38**
  - Timers **29**
  - Trouble reminder **28**
  - Verify-Prealarm **30**
  - Weekly occupancy schedule **40**
- Panel sounder **171**
- Panel Timers **29**
- PAS (Positive Alarm Sequence) **130**
  - Inhibit switch **130**

- Setting **30**
  - Password **12, 40**
    - Factory default settings **12**
    - Incorrect or forgotten **14**
    - Master **12, 13**
    - User **12, 14**
      - Level of access **14**
  - Piezo **21**
  - Point **171**
    - Selection for programming **46**
  - Point Program **46**
    - Autoprogram **71**
    - Delete Point **70**
    - Detector point **47**
      - See also Detector
    - Disable/Enable Point **78**
    - FAAST Baseline Reset **96**
    - FAAST Service Mode **95**
    - Module Point, SLC **55**
      - See also Module, SLC
    - Point select **46**
    - Zones **61–66**
  - Poll types **43**
  - Position 10 in zone map **49**
  - Position 9 in zone map **49**
  - Position one in zone map **48, 56, 60**
  - Power Management Mode **23**
  - Power-up Screen **99**
  - Pre-Alarm **137**
    - Action Level **138**
    - Alert Level **137**
    - See also Alarm Sensitivity **136**
    - Self-optimizing **136**
    - Sensitivity Levels **136**
    - To select sensitivity **138**
  - Prealarm (Action), fixed position zone **49**
  - Presignal delay **31**
  - Presignal Delay Timer/PAS **130**
  - Primary zone **47, 116, 171**
  - Printer Functions **16**
  - Printer supervision **38**
  - Program Time/Date **90**
  - Program/Alter Status **16**
  - Programming
    - ACS **32**
    - Alter Status **77–92**
    - Autoprogram **71**
    - Delete program **69**
    - Detector point **47–52**
    - First time, Delete Program Menu **17**
    - LCD screen **31**
    - Module point **55–60**
      - Control **59**
      - Monitor **56**
      - See also Module
    - Panel **18–46**
      - See also Panel settings
    - Point **46–76**
      - See also Point Program
    - Presence of unacknowledged alarm **12**
    - See also Point Program, Panel settings
    - Two levels
      - Alter Status **17**
      - Program **17**
    - Zones **61–66**
  - programming **61**
  - Proprietary Supervising Station **21**
- ## R
- Rapid All Call **23**
  - Rapid poll **43**
  - Read Status **16**
  - Receiving Station, see this panel's installation manual. **21**
  - Regional Settings **23, 165**
  - Release Audible Circuit
    - Output module configuration example **126**
    - To program **126**
  - Release Circuit
    - Output module configuration example **124**
    - To program **124**
  - Release Code Bell Circuit
    - Configuration example **128**
    - To program **127**
  - Release End Bell Circuit
    - Output module configuration example **122**
    - To program **122**
  - Release Form-C Circuit
    - Output module configuration example **125**
    - To program **125**
  - Releasing Applications **108–129**
    - Abort Switch **108**
    - ACS Annunciation **129**
    - Auxiliary Control Functions **129**
    - Cross Zones **108**
      - Types **116**
    - Delay Time **108**
    - Initiating Devices **128**
    - Soak Time **108**
    - Switches & Circuits, programming & configuration **118–128**
    - Warning sounders **129**
  - Releasing Zone
    - Address Format **47**
  - Releasing Zones (R0-R9) **146**
    - Type codes for inputs/outputs **117**
  - Reminder Menu Screen **28**
  - Remote Display Menu **41**
  - Reset **171**
    - AKS-1 **39**
    - Local control **21**
  - RF Weak Link Trouble Reporting **27**



**S**

screen navigation **20**  
 Scrolling **11**  
 Second Shot Switch  
     Monitor module configuration example **121**  
     To program **121**  
 selecting a field **20**  
 Self Test **99**  
 Self-Optimizing Pre-Alarm **136**  
 Sensitivity, see Alarm Sensitivity Levels, Detector  
 Service Screens **98**  
     Application Corrupt Screen **102**  
     Download screen **102**  
     LCM Download Menu **101**  
     Power-up screen **99**  
     Version Information **98**  
 Shutdown Wireless **95**  
 Signal Silence  
     AKS-1 **39**  
     Disabling with Silence Inhibit timer **30**  
     Local control **21**  
 Silence Inhibit Timer **30, 171**  
 Silenceable **60**  
 Silenceable Zone **61**  
 SLC (Signaling Line Circuit) **171**  
 SLC loop programming, *see* Loop programming  
 Smoke Control devices **32**  
 Smoothing **134**  
 Soak Time **108**  
 Sounder Base Setup **25**  
 Special Zone F0, notes and restrictions **130**  
 Special Zone Outputs **130**  
 Special Zones **147**  
 Standard Drill Mode **131**  
 STS-1 tamper switch **38**  
 Supervision **38**  
 Supplemental Documentation **9**  
 Switch Disable **94**  
 Switch Inhibit **60, 171**  
 Switches, service level, displayless mode **11**  
 SXS Settings **23**  
 System Troubles **160**

**T**

Tamper input **38**  
 Threshold, Channel A & B **19**  
 Time control, special zones **130**  
 Time zone **91**  
 Time-based functions **66**  
     Equations **150**  
 Timers **29**  
 TM-4 **29, 32, 131**  
 Trouble bus cable, for auxiliary trouble reporting **38**

Trouble Equations **152**

Trouble Zone **66, 146**

    Address format **47**

Trouble, Point - see this panel's Operations manual

Trouble, System **160**

Type Codes **55, 171**

    Explanation **154**

    For Intelligent Detectors **154**

    For Monitor Modules **156**

    For releasing zone inputs/outputs **117**

    For SLC output modules **157**

    See also Point Program **47**

    To select **154**

**U**

UDACT **29, 32**

UDACT-2 **29, 32**

UL Standard 864 **111, 112, 113, 115**

ULC Release Circuit

    Output module configuration example **123**

    To program **123**

ULC, auto silence value **30**

ULI Abort Switch **111**

USA Event Order **22**

User password, see Password **14**

UZC Zone Coder **32**

**V**

VeriFire™ Tools Program Utility **171**

    Use with displayless mode **11**

Verify-Prealarm **30**

Version Information **98**

Volume Control **69**

**W**

Walk Test **60, 83–89, 171**

    Abort **90**

    Advanced

        Audible **84**

    Basic **84**

    See also Alter Status **83**

    Type IDs, modules, that do not participate **60**

Warning

    Do not rely on Disable to disable releasing points during... **79, 108**

    If you replace any detector with a different type... **153**

    The IRI abort switch will only work if it is pushed before... **112**

Warning Sounders, releasing applications **129**

Weekly occupancy schedules **40, 50, 52**

Wireless **93**

Wiring Style **43**

wiring style, network **19**

## **Z**

Z000 general alarm **137**

Zone map

Control module **60**

Detector **48**

Monitor module **56**

Zones

CBE **146**

Fixed positions in map

Detectors, position one **49**

Detectors, position ten **49**

primary zone **47, 116**

Sounder/relay bases, position nine **49**

General Zone **61**

Non-resettable control **61**

Precedence Participation **61**

Zone label **61**

Logic **62**

Add logic function **64**

Add point **64**

Add Time/Date **64**

Delete equation **64**

Edit Equation **63**

Enter time **65**

Logic function **65**

Point select **64**

Position layout **47, 48**

Position one, initial programming **48, 56, 60**

Releasing **62, 108–129**

Abort Switch **62**

Cross Zone **62**

Delay Time **62**

Soak Time **62**

Special Zones **147**

Trouble **66**

Z000 general alarm **60, 138, 146**

## Manufacturer Warranties and Limitation of Liability

**Manufacturer Warranties.** Subject to the limitations set forth herein, Manufacturer warrants that the Products manufactured by it in its Northford, Connecticut facility and sold by it to its authorized Distributors shall be free, under normal use and service, from defects in material and workmanship for a period of thirty six months (36) months from the date of manufacture (effective Jan. 1, 2009). The Products manufactured and sold by Manufacturer are date stamped at the time of production. Manufacturer does not warrant Products that are not manufactured by it in its Northford, Connecticut facility but assigns to its Distributor, to the extent possible, any warranty offered by the manufacturer of such product. This warranty shall be void if a Product is altered, serviced or repaired by anyone other than Manufacturer or its authorized Distributors. This warranty shall also be void if there is a failure to maintain the Products and the systems in which they operate in proper working conditions.

MANUFACTURER MAKES NO FURTHER WARRANTIES, AND DISCLAIMS ANY AND ALL OTHER WARRANTIES, EITHER EXPRESSED OR IMPLIED, WITH RESPECT TO THE PRODUCTS, TRADEMARKS, PROGRAMS AND SERVICES RENDERED BY MANUFACTURER INCLUDING WITHOUT LIMITATION, INFRINGEMENT, TITLE, MERCHANTABILITY, OR FITNESS FOR ANY PARTICULAR PURPOSE. MANUFACTURER SHALL NOT BE LIABLE FOR ANY PERSONAL INJURY OR DEATH WHICH MAY ARISE IN THE COURSE OF, OR AS A RESULT OF, PERSONAL, COMMERCIAL OR INDUSTRIAL USES OF ITS PRODUCTS.

This document constitutes the only warranty made by Manufacturer with respect to its products and replaces all previous warranties and is the only warranty made by Manufacturer. No increase or alteration, written or verbal, of the obligation of this warranty is authorized. Manufacturer does not represent that its products will prevent any loss by fire or otherwise.

**Warranty Claims.** Manufacturer shall replace or repair, at Manufacturer's discretion, each part returned by its authorized Distributor and acknowledged by Manufacturer to be defective, provided that such part shall have been returned to Manufacturer with all charges prepaid and the authorized Distributor has completed Manufacturer's Return Material Authorization form. The replacement part shall come from Manufacturer's stock and may be new or refurbished. THE FOREGOING IS DISTRIBUTOR'S SOLE AND EXCLUSIVE REMEDY IN THE EVENT OF A WARRANTY CLAIM.

Warn-HL-08-2009.fm

 **NOTIFIER**<sup>®</sup>  
by Honeywell

World Headquarters  
12 Clintonville Road  
Northford, CT 06472-1610 USA  
203-484-7161  
fax 203-484-7118

[www.notifier.com](http://www.notifier.com)

**NATURSONNE**  
[www.natursonne.com.ar](http://www.natursonne.com.ar)



Pacheco 2060, CABA,  
Buenos Aires, Argentina  
Teléfono +54 11 4524-2655

**ISO 9001**  
**CERTIFIED**  
ENGINEERING & MANUFACTURING  
QUALITY SYSTEMS