



---

# Fire Alarm Control Panel **NFS2-640/E** Operations Manual

**NATURSONNE**



Pacheco 2060, CABA,  
Buenos Aires, Argentina  
Teléfono +54 11 4524-2655  
[www.natursonne.com.ar](http://www.natursonne.com.ar)

Document 52743	<b>L1</b>
10/03/2013	
P/N 52743:L1	ECN 13-0765

# Fire Alarm & Emergency Communication System Limitations

*While a life safety system may lower insurance rates, it is not a substitute for life and property insurance!*

**An automatic fire alarm system**—typically made up of smoke detectors, heat detectors, manual pull stations, audible warning devices, and a fire alarm control panel (FACP) with remote notification capability—can provide early warning of a developing fire. Such a system, however, does not assure protection against property damage or loss of life resulting from a fire.

**An emergency communication system**—typically made up of an automatic fire alarm system (as described above) and a life safety communication system that may include an autonomous control unit (ACU), local operating console (LOC), voice communication, and other various interoperable communication methods—can broadcast a mass notification message. Such a system, however, does not assure protection against property damage or loss of life resulting from a fire or life safety event.

The Manufacturer recommends that smoke and/or heat detectors be located throughout a protected premises following the recommendations of the current edition of the National Fire Protection Association Standard 72 (NFPA 72), manufacturer's recommendations, State and local codes, and the recommendations contained in the Guide for Proper Use of System Smoke Detectors, which is made available at no charge to all installing dealers. This document can be found at <http://www.systemsensor.com/appguides/>. A study by the Federal Emergency Management Agency (an agency of the United States government) indicated that smoke detectors may not go off in as many as 35% of all fires. While fire alarm systems are designed to provide early warning against fire, they do not guarantee warning or protection against fire. A fire alarm system may not provide timely or adequate warning, or simply may not function, for a variety of reasons:

**Smoke detectors** may not sense fire where smoke cannot reach the detectors such as in chimneys, in or behind walls, on roofs, or on the other side of closed doors. Smoke detectors also may not sense a fire on another level or floor of a building. A second-floor detector, for example, may not sense a first-floor or basement fire.

**Particles of combustion or "smoke"** from a developing fire may not reach the sensing chambers of smoke detectors because:

- Barriers such as closed or partially closed doors, walls, chimneys, even wet or humid areas may inhibit particle or smoke flow.
- Smoke particles may become "cold," stratify, and not reach the ceiling or upper walls where detectors are located.
- Smoke particles may be blown away from detectors by air outlets, such as air conditioning vents.
- Smoke particles may be drawn into air returns before reaching the detector.

The amount of "smoke" present may be insufficient to alarm smoke detectors. Smoke detectors are designed to alarm at various levels of smoke density. If such density levels are not created by a developing fire at the location of detectors, the detectors will not go into alarm.

Smoke detectors, even when working properly, have sensing limitations. Detectors that have photoelectronic sensing chambers tend to detect smoldering fires better than flaming fires, which have little visible smoke. Detectors that have ionizing-type sensing chambers tend to detect fast-flaming fires better than smoldering fires. Because fires develop in different ways and are often unpredictable in their growth, neither type

of detector is necessarily best and a given type of detector may not provide adequate warning of a fire.

Smoke detectors cannot be expected to provide adequate warning of fires caused by arson, children playing with matches (especially in bedrooms), smoking in bed, and violent explosions (caused by escaping gas, improper storage of flammable materials, etc.).

**Heat detectors** do not sense particles of combustion and alarm only when heat on their sensors increases at a predetermined rate or reaches a predetermined level. Rate-of-rise heat detectors may be subject to reduced sensitivity over time. For this reason, the rate-of-rise feature of each detector should be tested at least once per year by a qualified fire protection specialist. Heat detectors are designed to protect property, not life.

**IMPORTANT! Smoke detectors** must be installed in the same room as the control panel and in rooms used by the system for the connection of alarm transmission wiring, communications, signaling, and/or power. If detectors are not so located, a developing fire may damage the alarm system, compromising its ability to report a fire.

**Audible warning devices such as bells, horns, strobes, speakers and displays** may not alert people if these devices are located on the other side of closed or partly open doors or are located on another floor of a building. Any warning device may fail to alert people with a disability or those who have recently consumed drugs, alcohol, or medication. Please note that:

- An emergency communication system may take priority over a fire alarm system in the event of a life safety emergency.
- Voice messaging systems must be designed to meet intelligibility requirements as defined by NFPA, local codes, and Authorities Having Jurisdiction (AHJ).
- Language and instructional requirements must be clearly disseminated on any local displays.
- Strobes can, under certain circumstances, cause seizures in people with conditions such as epilepsy.
- Studies have shown that certain people, even when they hear a fire alarm signal, do not respond to or comprehend the meaning of the signal. Audible devices, such as horns and bells, can have different tonal patterns and frequencies. It is the property owner's responsibility to conduct fire drills and other training exercises to make people aware of fire alarm signals and instruct them on the proper reaction to alarm signals.
- In rare instances, the sounding of a warning device can cause temporary or permanent hearing loss.

**A life safety system** will not operate without any electrical power. If AC power fails, the system will operate from standby batteries only for a specified time and only if the batteries have been properly maintained and replaced regularly.

**Equipment used in the system** may not be technically compatible with the control panel. It is essential to use only equipment listed for service with your control panel.

**Telephone lines** needed to transmit alarm signals from a premises to a central monitoring station may be out of service or temporarily disabled. For added protection against telephone line failure, backup radio transmission systems are recommended.

**The most common cause** of life safety system malfunction is inadequate maintenance. To keep the entire life safety system

# Installation Precautions

*Adherence to the following will aid in problem-free installation with long-term reliability:*

**WARNING - Several different sources of power can be connected to the fire alarm control panel.** Disconnect all sources of power before servicing. Control unit and associated equipment may be damaged by removing and/or inserting cards, modules, or interconnecting cables while the unit is energized. Do not attempt to install, service, or operate this unit until manuals are read and understood.

**CAUTION - System Re-acceptance Test after Software Changes:** To ensure proper system operation, this product must be tested in accordance with NFPA 72 after any programming operation or change in site-specific software. Re-acceptance testing is required after any change, addition or deletion of system components, or after any modification, repair or adjustment to system hardware or wiring. All components, circuits, system operations, or software functions known to be affected by a change must be 100% tested. In addition, to ensure that other operations are not inadvertently affected, at least 10% of initiating devices that are not directly affected by the change, up to a maximum of 50 devices, must also be tested and proper system operation verified.

**This system** meets NFPA requirements for operation at 0-49° C/32-120° F and at a relative humidity 93% ± 2% RH (non-condensing) at 32°C ± 2°C (90°F ± 3°F). However, the useful life of the system's standby batteries and the electronic components may be adversely affected by extreme temperature ranges and humidity. Therefore, it is recommended that this system and its peripherals be installed in an environment with a normal room temperature of 15-27° C/60-80° F.

**Verify that wire sizes are adequate** for all initiating and indicating device loops. Most devices cannot tolerate more than a 10% I.R. drop from the specified device voltage.

**Like all solid state electronic devices,** this system may operate erratically or can be damaged when subjected to lightning induced transients. Although no system is completely immune from lightning transients and interference, proper grounding will reduce susceptibility. Overhead or outside aerial wiring is not recommended, due to an increased susceptibility to nearby lightning strikes. Consult with the Technical Services Department if any problems are anticipated or encountered.

**Disconnect AC power and batteries** prior to removing or inserting circuit boards. Failure to do so can damage circuits.

**Remove all electronic assemblies** prior to any drilling, filing, reaming, or punching of the enclosure. When possible, make all cable entries from the sides or rear. Before making modifications, verify that they will not interfere with battery, transformer, or printed circuit board location.

**Do not tighten screw terminals** more than 9 in-lbs. Overtightening may damage threads, resulting in reduced terminal contact pressure and difficulty with screw terminal removal.

**This system contains static-sensitive components.** Always ground yourself with a proper wrist strap before handling any circuits so that static charges are removed from the body. Use static suppressive packaging to protect electronic assemblies removed from the unit.

**Follow the instructions** in the installation, operating, and programming manuals. These instructions must be followed to avoid damage to the control panel and associated equipment. FACP operation and reliability depend upon proper installation.

Precau-D1-9-2005

## FCC Warning

**WARNING:** This equipment generates, uses, and can radiate radio frequency energy and if not installed and used in accordance with the instruction manual may cause interference to radio communications. It has been tested and found to comply with the limits for class A computing devices pursuant to Subpart B of Part 15 of FCC Rules, which is designed to provide reasonable protection against such interference when devices are operated in a commercial environment. Operation of this equipment in a residential area is likely to cause interference, in which case the user will be required to correct the interference at his or her own expense.

## Canadian Requirements

This digital apparatus does not exceed the Class A limits for radiation noise emissions from digital apparatus set out in the Radio Interference Regulations of the Canadian Department of Communications.

Le present appareil numerique n'emet pas de bruits radioelectriques depassant les limites applicables aux appareils numeriques de la classe A prescrites dans le Reglement sur le brouillage radioelectrique edicte par le ministere des Communications du Canada.

**HARSH™, NIS™, and NOTI-FIRE-NET™** are all trademarks; and **Acclimate® Plus, FlashScan®, NION®, NOTIFIER®, ONYX®, ONYXWorks®, UniNet®, VeriFire®, and VIEW®** are all registered trademarks of Honeywell International Inc. **Echelon®** is a registered trademark and **LonWorks™** is a trademark of Echelon Corporation. **ARCNET®** is a registered trademark of Datapoint Corporation. **Microsoft®** and **Windows®** are registered trademarks of the Microsoft Corporation.

©2013 by Honeywell International Inc. All rights reserved. Unauthorized use of this document is strictly prohibited.

## Software Downloads

In order to supply the latest features and functionality in fire alarm and life safety technology to our customers, we make frequent upgrades to the embedded software in our products. To ensure that you are installing and programming the latest features, we strongly recommend that you download the most current version of software for each product prior to commissioning any system. Contact Technical Support with any questions about software and the appropriate version for a specific application.

## Documentation Feedback

Your feedback helps us keep our documentation up-to-date and accurate. If you have any comments or suggestions about our online Help or printed manuals, you can email us.

Please include the following information:

- Product name and version number (if applicable)
- Printed manual or online Help
- Topic Title (for online Help)
- Page number (for printed manual)
- Brief description of content you think should be improved or corrected
- Your suggestion for how to correct/improve documentation

Send email messages to:

**FireSystems.TechPubs@honeywell.com**

Please note this email address is for documentation feedback only. If you have any technical issues, please contact Technical Services.

# Table of Contents

<b>Section 1: General Information.....</b>	<b>8</b>
1.1: UL 864 Compliance.....	8
1.2: About This Manual.....	8
1.2.1: Cautions and Warnings.....	8
1.2.2: Typographic Conventions.....	8
1.2.3: Supplemental Information.....	9
1.2.4: Shortcuts to Operating Functions.....	10
1.3: Introduction to the Control Panel.....	10
<b>Section 2: Use of the Controls.....</b>	<b>11</b>
2.1: Introduction.....	11
2.2: System Status Indicator LEDs.....	11
2.3: Control Keys.....	12
2.3.1: Acknowledge/Scroll Display.....	12
2.3.2: Signal Silence.....	13
2.3.3: System Reset.....	13
2.3.4: Drill.....	13
2.3.5: Lamp Test.....	14
2.4: Programming Keypad.....	14
<b>Section 3: Operation of the Control Panel.....</b>	<b>16</b>
3.1: Overview.....	16
3.2: Normal Mode of Operation.....	17
3.3: Fire Alarm Mode of Operation.....	17
3.3.1: How the Control Panel Indicates a Fire Alarm.....	17
3.3.2: How to Respond to a Fire Alarm.....	18
3.3.3: Interpreting Fire Alarm Type Codes.....	18
3.4: Mass Notification Mode of Operation.....	20
3.4.1: How the Control Panel Indicates a Mass Notification Alarm.....	20
3.4.2: How to Respond to an MN Alarm.....	20
3.4.3: How the Control Panel Indicates a Mass Notification Supervisory.....	21
3.4.4: How to Respond to an MN Supervisory.....	21
3.4.5: How the Control Panel Indicates a Mass Notification Trouble.....	22
3.4.6: How to Respond to an MN Trouble.....	22
3.4.7: Interpreting MN Type Codes.....	23
3.5: System Trouble Mode of Operation.....	23
3.5.1: How the Control Panel Indicates a System Trouble.....	23
3.5.2: How to Respond to a System Trouble.....	24
3.6: Security Alarm Mode of Operation.....	25
3.6.1: How the Control Panel Indicates a Security Alarm.....	25
3.6.2: How to Respond to a Security Alarm.....	25
3.6.3: Interpreting Security Type Codes.....	26
3.7: Active Supervisory Signal Mode of Operation.....	26
3.7.1: How the Control Panel Indicates an Active Supervisory.....	26
3.7.2: How to Respond to an Active Supervisory.....	27
3.7.3: How to Interpret Supervisory Type Codes.....	27
3.8: Pre-Alarm Warning Mode of Operation.....	28
3.8.1: How the Control Panel Indicates a Pre-Alarm Warning.....	28
3.8.2: How to Respond to a Pre-Alarm Warning.....	29
3.9: Disabled Points Mode of Operation.....	30
3.10: Non-Alarm Mode of Operation.....	30
3.10.1: Purpose of Non-Alarm Points.....	30
3.10.2: How the Control Panel Indicates an Active Fire Control.....	31
3.10.3: How the Control Panel Indicates an Active Non-Fire Point.....	31
3.11: CO Alarm Mode of Operation.....	31

3.11.1: How the Control Panel Indicates a CO Alarm.....	31
3.11.2: How to Respond to a CO Alarm.....	32
3.11.3: Interpreting CO Alarm/Supervisory Type Codes .....	32
3.12: Active Trouble Monitor Mode of Operation.....	33
3.12.1: How the Control Panel Indicates an Active Trouble Monitor .....	33
3.12.2: How to Respond to an Active Trouble Monitor .....	33
3.13: Output Circuit Trouble Mode of Operation .....	34
3.13.1: Overview.....	34
3.13.2: How the Control Panel Indicates a NAC Trouble .....	35
3.13.3: How the Control Panel Indicates a Control/Relay Trouble .....	35
3.13.4: How to Respond to a NAC or Control/Relay Trouble .....	35
3.14: Operation of Special System Timers .....	36
3.14.1: What are System Timers?.....	36
3.14.2: How to View System Timer Selections.....	36
3.14.3: How System Timers Work .....	36
3.15: Waterflow Circuit Operation.....	37
3.16: Style 6 and Style 7 Operation .....	37
<b>Section 4: Read Status Operation .....</b>	<b>38</b>
4.1: Introduction.....	38
4.2: What is Read Status?.....	38
4.2.1: Quick Reference Key Sequences.....	38
4.3: Entering Read Status.....	38
4.4: Viewing and Printing a Read Status.....	39
4.4.1: How to View Read Status of Devices, Zones, & System Settings .....	39
4.4.2: How to View Read Status for Event and Alarm History.....	49
4.4.3: How to Print Points, Event and Alarm History .....	50
4.4.4: How to View and Print Hidden Event and Alarm History .....	52
<b>Appendix A: Special Zone Operation .....</b>	<b>53</b>
A.1: Overview.....	53
A.2: Releasing Zones (R0-R9).....	53
A.2.1: Purpose of Releasing Zones.....	53
A.2.2: How to View Releasing Zone Selections .....	54
A.2.3: How Releasing Zones Operate .....	54
A.3: Time, Date, and Holiday Functions .....	56
A.3.1: Overview.....	56
A.3.2: How to View Time Control Selections.....	56
A.3.3: How to View Holiday Function Selections .....	57
A.3.4: How Time Control and Holiday Functions Work .....	57
A.4: NAC Coding .....	58
A.4.1: Overview of Coding.....	58
A.4.2: How to View Coding (F8) Selections.....	58
A.4.3: How to Respond to an Alarm with Coding.....	59
A.5: Presignal and Positive Alarm Sequence (PAS) Operation .....	59
A.5.1: Overview.....	59
A.5.2: What is Presignal and PAS? .....	59
A.5.3: How to View Presignal and PAS Selections .....	60
A.5.4: How to Respond to an Alarm with Presignal Delay Timer (no PAS).....	60
A.5.5: How to Respond to an Alarm with Presignal Delay Timer (PAS selected) .....	61
<b>Appendix B: Intelligent Detector Functions .....</b>	<b>62</b>
<b>Appendix C: Remote Terminal Access .....</b>	<b>64</b>
C.1: General Description.....	64
C.2: Operating Modes .....	64
C.2.1: Local Terminal Mode (LocT) .....	64
C.2.2: Local Monitor Mode (LocM).....	65

---

C.2.3: Remote Terminal Mode (RemT) .....	65
C.3: Using the CRT-2 for Read Status .....	66
C.3.1: Overview .....	66
C.3.2: Accessing Read Status Options .....	66
C.3.3: Read Point .....	67
C.3.4: Display Devices in Alarm or Trouble .....	67
C.3.5: Display All Programmed Points .....	68
C.3.6: Step-through History .....	68
C.3.7: View All History .....	68
C.3.8: Step-through Alarm History .....	68
C.3.9: View All Alarm History .....	68
C.4: Using the CRT-2 for Alter Status .....	69
C.4.1: Overview .....	69
C.4.2: Accessing Alter Status Options .....	69
C.4.3: Enable or Disable Detectors, Modules or Zones .....	70
C.4.4: Change Alarm and Pre-Alarm Levels .....	70
C.4.5: Clear Verification Counter .....	71
C.4.6: Clear the Entire History Buffer .....	71
C.4.7: Set the Pre-Alarm for Alert or Action .....	71
<b>Appendix D: Point and System Troubles Lists .....</b>	<b>72</b>
D.1: Point (Device) Troubles .....	72
D.2: System Troubles .....	73
<b>Index .....</b>	<b>76</b>

# Section 1: General Information

## 1.1 UL 864 Compliance

This product has been certified to comply with the requirements in the Standard for Control Units and Accessories for Fire Alarm Systems, UL 864 9th Edition.

## 1.2 About This Manual

### 1.2.1 Cautions and Warnings

This manual contains cautions and warnings to alert the reader as follows:



---

**CAUTION:**

INDICATES INFORMATION ABOUT PROCEDURES THAT COULD CAUSE PROGRAMMING ERRORS, RUNTIME ERRORS, OR EQUIPMENT DAMAGE.

---



---

**WARNING:**

INDICATES INFORMATION ABOUT PROCEDURES THAT COULD CAUSE IRREVERSIBLE DAMAGE TO THE CONTROL PANEL, IRREVERSIBLE LOSS OF PROGRAMMING DATA OR PERSONAL INJURY.

---

### 1.2.2 Typographic Conventions

This manual uses the following typographic conventions as listed in below:

When you see	Specifies	Example
text in small caps	the text as it appears in the LCD display or on the control panel	MARCH TIME is a selection that appears in the LCD display; or Press the ENTER key
text in quotes	a reference to a section or a LCD menu screen	"Read Status"; specifies the Read Status section or menu screen
bold text	In body text, a number or character that you enter	Press <b>1</b> ; means to press the number "1" on the keypad
italic text	a specific document	<i>NFS2-640 Installation Manual</i>
a graphic of the key	In a graphic, a key as it appears on the control panel	Press  means to press the Escape key

**Table 1.1 Typographic Conventions in this Manual**



---

**NOTE:** In this manual, the term NFS2-640 is used to refer to the NFS2-640 and NFS2-640E unless otherwise noted.

---



## 1.2.3 Supplemental Information

The table below provides a list of documents referenced in this manual, as well as documents for selected other compatible devices. The document series chart (DOC-NOT) provides the current document revision. A copy of this document is included in every shipment.

<b>Compatible Conventional Devices (Non-addressable)</b>	<b>Document Number</b>
Device Compatibility Document	15378
<b>Fire Alarm Control Panel (FACP) and Main Power Supply Installation</b>	<b>Document Number</b>
NFS2-640 Installation, Operations, and Programming Manuals	52741, 52742, 52743
DVC Digital Voice Command Manual	52411
DAL Devices Reference Document	52410
DVC-RPU Manual	50107425-001
DVC-RPU UL Listing Document	50107424-001
DAA2 and DAX Amplifiers Manual	53265
DS-DB Digital Series Distribution Board and Amplifiers Manual	53622
SLC Wiring Manual	51253
Note: For individual SLC Devices, refer to the <i>SLC Wiring Manual</i>	
<b>Off-line Programming Utility</b>	<b>Document Number</b>
VeriFire® Tools CD help file	VERIFIRE-TCD
Veri•Fire Medium Systems Help File	VERIFIRE-CD
<b>Cabinets &amp; Chassis</b>	<b>Document Number</b>
CAB-3/CAB-4 Series Cabinet Installation Document	15330
Battery/Peripherals Enclosure Installation Document	50295
<b>Power Supplies, Auxiliary Power Supplies &amp; Battery Chargers</b>	<b>Document Number</b>
ACPS-610/E Instruction Manual	53018
ACPS-2406 Installation Manual	51304
APS-6R Instruction Manual	50702
APS2-6R Instruction Manual	53232
CHG-120 Battery Charger Manual	50641
FCPS-24 Field Charger/Power Supply Manual	50059
FCPS-24S6/8 Field Charger/Power Supply Manual (Sync)	51977
<b>Networking</b>	<b>Document Number</b>
Noti•Fire•Net Manual, Network Version 5.0 & Higher	51584
High-Speed Noti•Fire•Net Manual	54013
NCM-W/F Installation Document	51533
HS-NCM High-Speed NCM Document	54014
NCS Network Control Station Manual, Network Version 5.0 & Higher	51658
Onyxworks Workstation	52305, 52306, 52307
<b>System Components</b>	<b>Document Number</b>
Annunciator Control System Manual	15842
Annunciator Fixed Module Manual	15048
AFM-16A Annunciator Fixed Module Manual	15207
ACM-8R Annunciator Control Module Manual	15342
FDU-80 Remote Annunciator Manual	51264
LDM Series Lamp Driver Annunciator Manual	15885

**Table 1.2 Supplemental Documentation (1 of 2)**

NCA-2 Network Control Annunciator Manual	52482
SCS Smoke Control Manual (Smoke and HVAC Control Station)	15712
RPT-485W/RPT-485WF EIA-485 Annunciator Loop Repeater Manual	15640
DPI-232 Direct Panel Interface Manual	51499
TM-4 Installation Document (Reverse Polarity Transmitter)	51490
UDACT Manual (Universal Digital Alarm Communicator/Transmitter)	50050
UDACT-2 (Universal Digital Alarm Communicator/Transmitter) Listing Document	54089LD
UDACT-2 Manual (Universal Digital Alarm Communicator/Transmitter)	54089
ACT-2 Installation Document	51118
FireVoice 25/50 & FireVoice 25/50ZS Manual	52290
RM-1 Series Remote Microphone Installation Document	51138
RA100Z Remote LED Annunciator Installation Document	156-508
XP10-M Installation Document	156-1803
XP6-C Installation Document	156-1805
XP6-MA Installation Document	156-1806
XP6-R Installation Document	156-1804
LCD-80 Liquid Crystal Display Remote Annunciator	15037
LCD2-80 Liquid Crystal Display Remote Annunciator	53242

**Table 1.2 Supplemental Documentation (2 of 2)**

## 1.2.4 Shortcuts to Operating Functions

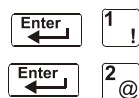

To the left of each program function, you'll find a keypad shortcut, which contains a series of keypad entries required to access the program function. All shortcuts start with the control panel in normal operation.

For example, the keypad shortcut to the left, shows how to enter the Read Status function with the control panel in normal operation, as well as how to exit the function.

## 1.3 Introduction to the Control Panel

The NFS2-640 is a modular, intelligent Fire Alarm Control Panel (FACP) with features suitable for most applications. Following is a list of operating features available.

- Alarm Verification selection, to reduce unwanted alarms, for intelligent detector points
- Positive Alarm Sequence (PAS) and Presignal per NFPA 72
- Silence Inhibit timer and Auto Silence timer for Notification Appliance Circuits (NACs)
- March time/temporal code for Notification Appliance Circuits (NACs)
- Programmable Signal Silence, System Reset, and Alarm Activate functions through monitor modules
- Automatic time-of-day and day-of-week control functions, with holiday option
- Intelligent Sensing with nine field-adjustable Pre-Alarm levels with programmable Control-By-Event (CBE)
- Operate automatic smoke or heat detector sounder base on action Pre-Alarm level, with general evacuation on alarm level
- Security alarm point option with separate audible signal code
- Centralized voice paging and audible alarm signaling options
- Programmable Control-By-Event control of outputs from individual alarm or supervisory addressable devices
- Networks with other FACPs and equipment for large applications.

# Section 2: Use of the Controls

## 2.1 Introduction

Listing of the controls and indicators and where to find information on their use:

Operating Components	Covered in
Twelve System Status Indicator LEDs	"System Status Indicator LEDs" on page 11
Five Control Keys	"Control Keys" on page 12
Programming Keypad	"Programming Keypad" on page 14

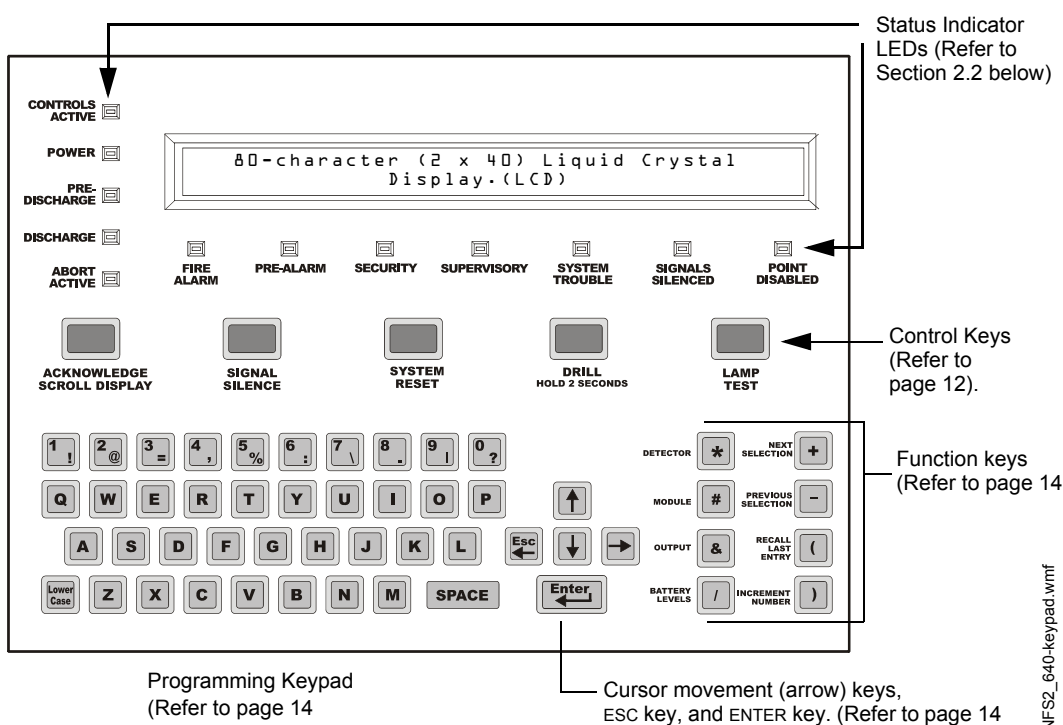

Figure 2.1 NFS2-640 Control Panel Keys and Indicators

## 2.2 System Status Indicator LEDs

The control panel contains 12 labeled LEDs described in Table 2.1.

Indicator	Color	When Active	To Turn Off
CONTROLS ACTIVE	Green	Lights when the panel assumes control of local operation as primary display.	Turns off automatically when another panel assumes control of local operation.
POWER	Green	Lights when the proper primary AC power is applied. Remains lit while power is applied.	Always lit with AC power applied.
PRE-DISCHARGE	Red	Lights when any of the releasing zones have been activated, but have not yet discharged a releasing agent.	Turns off automatically when no releasing zones are in the pre-discharge state.

Table 2.1 Descriptions of System Status Indicator LEDs (1 of 2)

Indicator	Color	When Active	To Turn Off
DISCHARGE	Red	Lights when any of the releasing zones are active and in the process of discharging a releasing agent.	Turns off automatically when no releasing zones are discharging a releasing agent.
ABORT ACTIVE	Yellow	Lights when an abort switch has been activated.*	Turns off automatically when an abort switch has been pressed and its timer is still counting down.
FIRE ALARM	Red	Flashes when a non-acknowledged fire alarm exists. Lights steadily after you acknowledge the fire alarm.	Clear the alarm condition and reset the system.
PRE-ALARM	Red	Flashes when a non-acknowledged fire Pre-Alarm exists. Lights steadily after you acknowledge the Pre-Alarm.	Clear the pre-alarm condition. (An Action Pre-Alarm requires a system reset.)
SECURITY	Blue	Flashes when a non-acknowledged Security alarm exists. Lights steadily after you acknowledge the alarm.	Clear the Security alarm condition and reset the system.
SUPERVISORY	Yellow	Flashes when a non-acknowledged Supervisory condition exists. Lights steadily after you acknowledge the event.	Clear the condition (Supervisory inputs require a system reset if they are latching. Refer to Table 3.4 page 28 for latching information.).
SYSTEM TROUBLE	Yellow	Flashes when a non-acknowledged system trouble exists. Lights steadily after you acknowledge the trouble.	Clear the trouble condition.
SIGNALS SILENCED	Yellow	Lights steadily after a fire alarm condition occurs and after you press SIGNAL SILENCE to silence all outputs. Flashes to indicate that some silenceable outputs are on and some are off.	Press SYSTEM RESET. DRILL will also turn off the LED.
POINT DISABLED	Yellow	Lights when one or more system devices are disabled.	Enable the device or remove the disabled device from the system program.

**Table 2.1 Descriptions of System Status Indicator LEDs (2 of 2)**

- \* Activation of a Manual Release Switch will override Predischarge Delay and override an active Abort Release Switch, resulting in an immediate agent release.

## 2.3 Control Keys

The control panel provides five Control Keys as described below:

### 2.3.1 Acknowledge/Scroll Display

Use the ACKNOWLEDGE/SCROLL DISPLAY key to respond to new alarm or trouble signals. When pressed, the control panel does the following:

- Silences the panel sounder
- Changes all active LED indicators from flashing to steady
- Sends an Acknowledge message to the History buffer and installed printers, CRT-2 terminals, and FDU-80 annunciators
- Sends a signal to silence the sounders on the FDU-80 and ACS annunciators

You can also press this key to display multiple alarms or troubles. If more than one alarm or trouble exists, the control panel displays the next alarm or trouble for 3 seconds (or until you press the ACKNOWLEDGE/SCROLL DISPLAY key), then displays the next alarm or trouble.



**NOTE:** If Local Control is set to "0" (No Control), the FACP will not respond to ACKNOWLEDGE, and the piezo will not sound.

## 2.3.2 Signal Silence

Use the SIGNAL SILENCE key to silence the panel sounder and turn off all audio and visual devices connected to Notification Appliance Circuits. When pressed, the control panel does the following:

- Turns off the panel sounder
- Turns off all silenceable output circuits
- Lights the SIGNALS SILENCED LED
- Sends a SIGNALS SILENCED message to the History buffer and installed printers, CRT-2 terminals, and annunciators

### Partial Signal Silence

When some active outputs are silenced and others remain constant, the SIGNALS SILENCED LED will flash.



---

**NOTE:** If Local Control is set to “0” (No Control) or “2” (Partial Control), the FACP will not respond to SIGNAL SILENCE.

---

## 2.3.3 System Reset

Use the SYSTEM RESET key to reset the control panel. When pressed, the control panel does the following:

- Clears ALL active inputs
- Interrupts resettable power
- Sends a “System Reset” message to the History buffer, and installed printers, CRT-2 terminals, and FDU-80 annunciators
- Decouples from Noti•Fire•Net, if connected, for 60 seconds to allow Cooperative Control By Event (CCBE) to clear.

If any alarm or trouble exists after you press the SYSTEM RESET key, all NACs, control outputs, and panel audio and visual indicators will reactivate.



---

**NOTE:** Trouble conditions will not clear and re-report upon reset.

---



---

**NOTE:** If Local Control is set to “0” (No Control), the FACP will not respond to SYSTEM RESET.

---

## 2.3.4 Drill

Use the DRILL key to manually activate all silenceable outputs and Notification Appliance Circuits. To prevent accidental activation, you must press the DRILL key for 2 seconds. When pressed, the control panel does the following:

- Turns on all silenceable NACs
- Turns off the SIGNALS SILENCED LED
- Sends a Manual Evacuate message to the History buffer and installed printers, CRT-2 terminals, and FDU-80 annunciators



---

**NOTE:** If Local Control is set to “0” (No Control) or “2” (Partial Control), the FACP will not respond to DRILL.

---

### 2.3.5 Lamp Test

Use the LAMP TEST key to test the control panel LEDs and the panel sounder. When pressed and held, the control panel does the following:

- Lights all control panel LEDs
- Turns on the panel sounder
- Lights all segments of the LCD display. When the LAMP TEST key is held for longer than five seconds, the LCD will display the Software Revisions.

## 2.4 Programming Keypad

The programming keypad includes:

- Function keys: DETECTOR, MODULE, OUTPUT, BATTERY LEVELS, NEXT SELECTION, PREVIOUS SELECTION, RECALL LAST ENTRY, and INCREMENT NUMBER
- ENTER key
- Cursor movement keys: ESC/LEFT ARROW key, UP key, RIGHT key, DOWN key
- Alphabetic and numeric keys, with LOWER CASE selection key

Shown below is the Programming Keypad, with descriptions for the keys.

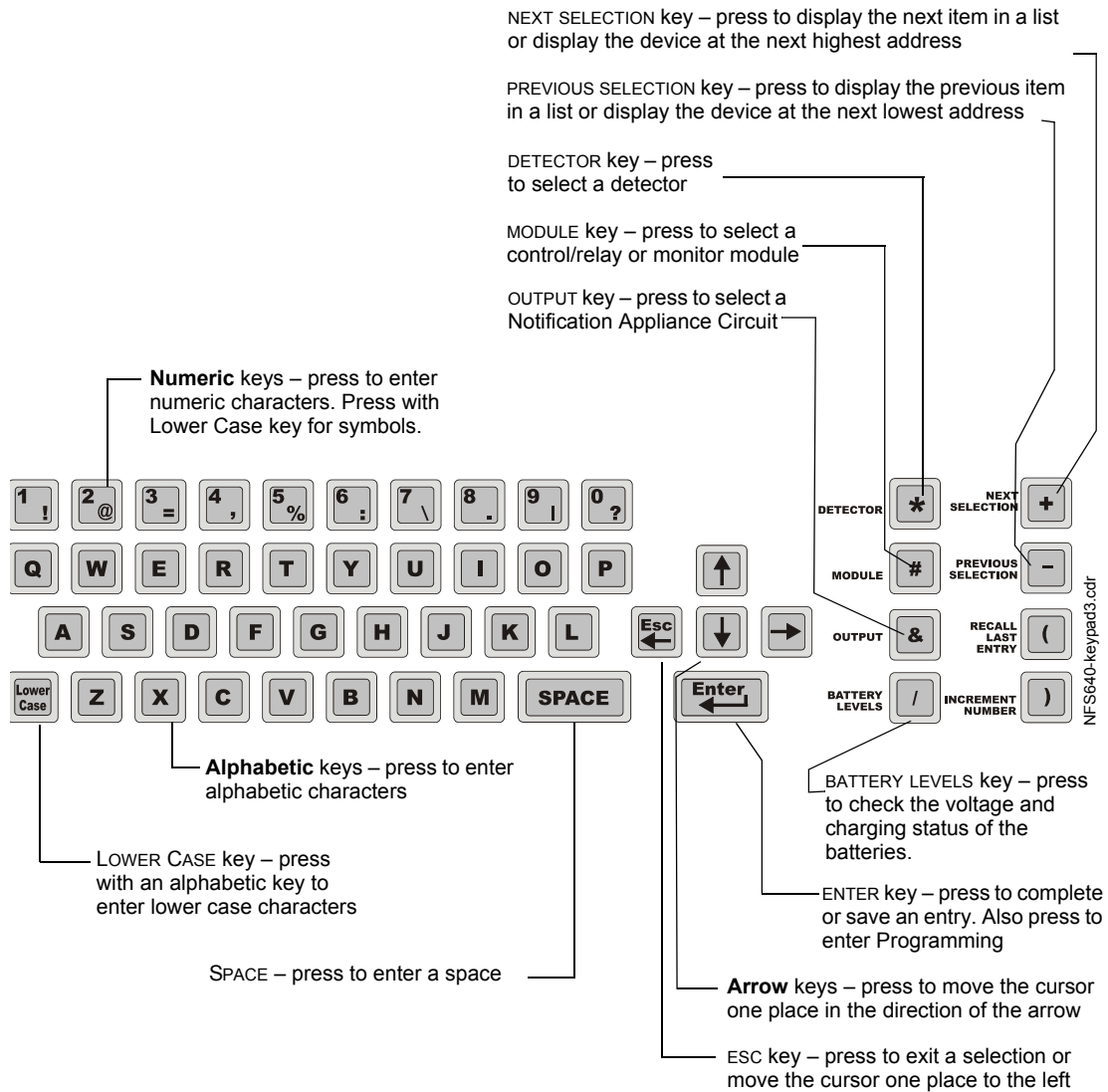

Figure 2.2 Programming Keypad

# Section 3: Operation of the Control Panel

## 3.1 Overview

This section contains instructions for operating the control panel. Listed below are the topics detailed in this section:

Section	Refer to Page
3.2, "Normal Mode of Operation"	page 17
3.3, "Fire Alarm Mode of Operation"	page 17
3.4, "Mass Notification Mode of Operation"	page 20
3.5, "System Trouble Mode of Operation"	page 23
3.6, "Security Alarm Mode of Operation"	page 25
3.7, "Active Supervisory Signal Mode of Operation"	page 26
3.8, "Pre-Alarm Warning Mode of Operation"	page 28
3.9, "Disabled Points Mode of Operation"	page 30
3.10, "Non-Alarm Mode of Operation"	page 30
3.11, "CO Alarm Mode of Operation"	page 31
3.12, "Active Trouble Monitor Mode of Operation"	page 33
3.12, "Active Trouble Monitor Mode of Operation"	page 33
3.13, "Output Circuit Trouble Mode of Operation"	page 34
3.14, "Operation of Special System Timers"	page 36
3.15, "Waterflow Circuit Operation"	page 37
3.16, "Style 6 and Style 7 Operation"	page 37

This manual also contains information on operating the control panel in the appendixes, listed as follows:

- Appendix A, "Special Zone Operation", on page 53
- Appendix B, "Intelligent Detector Functions", on page 62
- Appendix C, "Remote Terminal Access", on page 64
- Appendix D, "Point and System Troubles Lists", on page 72



---

**WARNING:**

WHEN USED FOR CO<sub>2</sub> RELEASING APPLICATIONS, OBSERVE PROPER PRECAUTIONS AS STATED IN NFPA 12. DO NOT ENTER THE PROTECTED SPACE UNLESS PHYSICAL LOCKOUT AND OTHER SAFETY PROCEDURES ARE FULLY COMPLETED. DO NOT USE SOFTWARE DISABLE FUNCTIONS IN THE PANEL AS LOCKOUT.

---



## 3.2 Normal Mode of Operation

The system operates in Normal mode when no alarms or troubles exist. In Normal mode, the control panel displays a System Normal message as follows

```
SYSTEM NORMAL      01:56P 041508 Sat
```

**Figure 3.1 Sample System Normal Message**

In Normal mode, the control panel does the following functions at regular intervals:

- Polls all SLC devices and the four NACs to check for valid replies, alarms, troubles, circuit integrity, supervisory signals, etc.
- Checks power supply troubles and batteries at 10-second intervals
- Sends a supervisory query on the optional FDU-80 and verifies proper response
- Refreshes the LCD display and the optional FDU-80 display and updates time
- Scans for any keypad or Control Key entries
- Performs a detector automatic test operation
- Tests system memory
- Monitors for microcontroller failure

## 3.3 Fire Alarm Mode of Operation

### 3.3.1 How the Control Panel Indicates a Fire Alarm

When an initiating device (detector or monitor module) activates, the control panel does the following:

- Produces a steady audible tone
- Activates the System Alarm relay (TB4)
- Flashes the FIRE ALARM LED
- Displays a Type Code that indicates the type of device that activated the fire alarm
- Displays ALARM in the status banner on the LCD display, along with information specific to the device, as shown below:

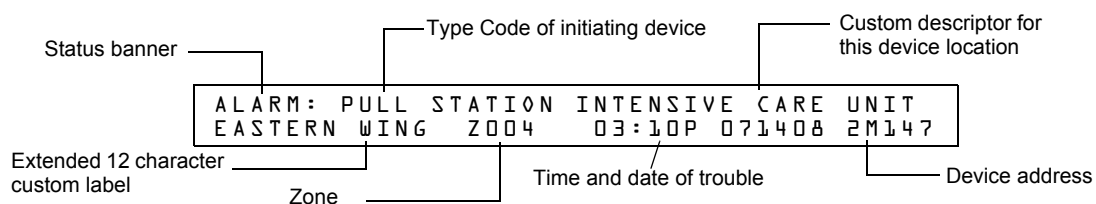

**Figure 3.2 Sample Fire Alarm Display**

- Sends an Alarm message to the LCD display, remote annunciators, History buffer, installed printers, and CRT-2s.
- Latches the control panel in alarm. (You can not return the control panel to normal operation until you correct the alarm condition and reset the control panel)
- Initiates any Control-By-Event actions
- Starts timers (such as Silence Inhibit, Auto Silence)
- Activates the general alarm zone (Z00)

### 3.3.2 How to Respond to a Fire Alarm

If the control panel indicates a fire alarm, you can do the following:

- To silence only the panel sounder:  
Press the ACKNOWLEDGE/SCROLL DISPLAY key. The local sounder will silence and the FIRE ALARM LED will change from flashing to steady.  
The control panel will send an acknowledge message to the LCD display, remote annunciators, history buffer, installed printers, and CRT-2s.
- To silence the panel sounder and any activated outputs that are programmed as silenceable:  
Press the SIGNAL SILENCE key. The FIRE ALARM LED and SIGNALS SILENCED LED light steady.  
The control panel sends a Signal Silenced message to the remote annunciators, history buffer, installed printers, and CRT-2s. The figure below shows a sample Alarm Silenced message.

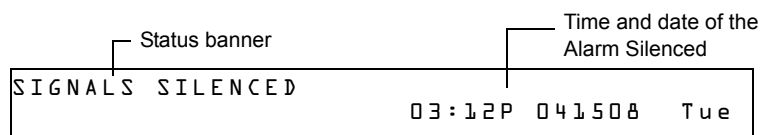

**Figure 3.3 Sample Alarm Silenced Message**

1. Check the Alarm message for the location and type of trouble.
2. Correct the condition causing the alarm.
3. When you finish correcting the alarm condition, press the SYSTEM RESET key to return the control panel to normal operation (indicated by the “System Normal” message). The control panel sends a “System Normal” message to the LCD display, History buffer and installed printers, FDU-80 annunciators, and CRT-2s.

### 3.3.3 Interpreting Fire Alarm Type Codes

The Type Code that displays in the Alarm message indicates the function of the point that initiates the fire alarm. For example, a monitor module with a PULL STATION Type Code means that the monitor module connects to a manual pull station. The table below lists the Type Codes that can appear in an alarm message:

Type Code	Latching (Y/N)	Purpose	What it does
<b>Monitor Modules</b>			
Blank	Y	Indicates activation of a device with no description	Lights FIRE ALARM LED and activates CBE
HEAT DETECT	Y	Indicates activation of a conventional heat detector	Lights FIRE ALARM LED and activates CBE
MONITOR	Y	Indicates activation of an alarm-monitoring device	Lights FIRE ALARM LED and activates CBE
PULL STATION	Y	Indicates activation of a manual fire-alarm-activating device, such as a pull station.	Lights FIRE ALARM LED and activates CBE
RF MON MODUL	Y	Indicates activation of a wireless alarm-monitoring device	Lights FIRE ALARM LED and activates CBE
RF PULL STA	Y	Indicates activation of a wireless manual fire-alarm-activating device, such as a pull station	Lights FIRE ALARM LED and activates CBE
SMOKE CONVEN	Y	Indicates activation of a conventional smoke detector attached to an FZM-1	Lights FIRE ALARM LED and activates CBE
SMOKE DETECT	Y	Indicates activation of a conventional smoke detector attached to an FZM-1	Lights FIRE ALARM LED and activates CBE
WATERFLOW	Y	Indicates activation a waterflow alarm switch	Lights FIRE ALARM LED and activates CBE
EVACUATE SW	N	Performs Drill function.	Activates all silenceable outputs

**Table 3.1 Fire Alarm Type Codes (1 of 2)**

Type Code	Latching (Y/N)	Purpose	What it does
MAN. RELEASE	Y	Indicates activation of a monitor module programmed to a releasing zone to perform a releasing function.	Lights FIRE ALARM LED and activates CBE
MANREL DELAY	Y	Indicates activation of a monitor module programmed for a release output	Lights FIRE ALARM LED and activates CBE
SECOND SHOT	N	Provides second activation of releasing zone after soak timer has expired.	Indicates ACTIVE and activates CBE
CO MONITOR*	Y	Indicates activation of a CO conventional detector	Activates CBE, does not light an indicator at the control panel.
<b>Detectors</b>			
SMOKE(ION)	Y	Indicates activation of an ion smoke detector	Lights FIRE ALARM LED and activates CBE
SMOKE(DUCT I)	Y	Indicates activation of a duct ion smoke detector	Lights FIRE ALARM LED and activates CBE
SMOKE(PHOTO)	Y	Indicates activation of a photo smoke detector	Lights FIRE ALARM LED and activates CBE
RF_PHOTO	Y	Indicates activation of a wireless photoelectric smoke detector	Lights FIRE ALARM LED and activates CBE
SMOKE(DUCTP)	Y	Indicates activation of a duct photo smoke detector	Lights FIRE ALARM LED and activates CBE
SMOKE(HARSH)*	Y	Indicates activation of a HARSH smoke detector	Lights FIRE ALARM LED and activates CBE
SMOKE(LASER)	Y	Indicates activation of a laser smoke detector	Lights FIRE ALARM LED and activates CBE
SMOKE(DUCTL)	Y	Indicates activation of a duct laser smoke detector	Lights FIRE ALARM LED and activates CBE
SMOKE(BEAM)	Y	Indicates activation of a beam smoke detector	Lights FIRE ALARM LED and activates CBE
SMOKE(DUCTL)	Y	Indicates activation of a duct laser smoke detector	Lights FIRE ALARM LED and activates CBE
AIR REF	Y	Indicates activation of a laser air reference detector.	Lights FIRE ALARM LED and activates CBE
HEAT	Y	Indicates activation of a 190°F intelligent thermal detector	Lights FIRE ALARM LED and activates CBE
HEAT+	Y	Indicates activation of a 190°F adjustable threshold intelligent thermal detector	Lights FIRE ALARM LED and activates CBE
HEAT(ANALOG)	Y	135°F intelligent thermal sensor	Lights FIRE ALARM LED and activates CBE
HEAT (ROR)	Y	15°F per minute rate-of-rise detector	Lights FIRE ALARM LED and activates CBE
SMOKE ACCLIM	Y	Indicates activation of detector (Acclimate Plus™, FSC-851 IntelliQuad), without freeze warning	Lights FIRE ALARM LED and activates CBE
SMOKE (ACCL+)	Y	Indicates activation of detector (Acclimate Plus™, FSC-851 IntelliQuad), with freeze warning	Lights FIRE ALARM LED and activates CBE
SMOKE MULTI*	Y	Multisensor smoke detector	Lights FIRE ALARM LED and activates CBE
PHOTO/CO*	Y	Indicates activation of the Photo, Heat, or CO element of a detector.	Lights FIRE ALARM LED for photo and heat, no LED will light for a CO alarm. Photo and heat will activate CBE, CO alarm activates special function zone FC and sixth CBE zone only (sixth CBE zone programmable via VeriFire Tools)
PHOTO/CO (P SUP)*	Y	Indicates activation of the Photo, Heat or CO element of a detector.	Lights FIRE ALARM LED for heat, no LED will light for a CO alarm, supervisory LED will light for photo alarm, heat and photo will activate CBE, CO alarm activates special function zone FC and sixth CBE zone only (sixth CBE zone programmable via VeriFire Tools)
PHOTO/CO (C SUP)*	Y	Indicates activation of the Photo, Heat or CO element of a detector.	Lights FIRE ALARM LED for heat and photo alarms, will light supervisory LED for CO alarm, photo and heat alarms will activate CBE, CO alarm will activate sixth CBE zone only (sixth CBE zone programmable via VeriFire Tools)

\*FlashScan only

Table 3.1 Fire Alarm Type Codes (2 of 2)

## 3.4 Mass Notification Mode of Operation

### 3.4.1 How the Control Panel Indicates a Mass Notification Alarm

When an initiating device activates, the control panel does the following:

- Produces a steady audible tone
- Does not activate any alarm relays or devices programmed as Alarm Pending or General Pending
- Does not flash any panel LEDs
- Displays a Type Code that indicates the type of device that activated the MN alarm
- Displays MN ALARM in the status banner on the LCD display, along with information specific to the device, as shown below:

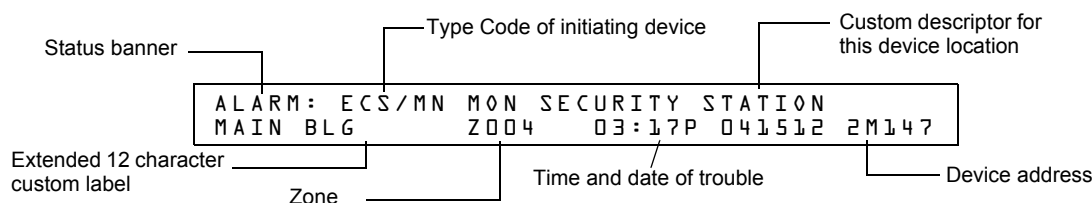

**Figure 3.4 Sample MN Alarm Display**

- Sends an Alarm message to the LCD display, remote annunciators, History buffer, installed printers, and CRT-2s.
- Latches the control panel in MN alarm. (You can not return the control panel to normal operation until you correct the alarm condition and reset the control panel)
- Initiates any Control-By-Event actions
- Activates special zone ZFD (Not applicable for First Command applications)
- Sends an Alarm message to the proprietary receiver via the network, if applicable

### 3.4.2 How to Respond to an MN Alarm

If the control panel indicates an MN alarm, you can do the following:

- To silence only the panel sounder:

Press the ACKNOWLEDGE/SCROLL DISPLAY key on a network control device. The local sounder will silence. The control panel will send an acknowledge message to the LCD display, remote annunciators, history buffer, installed printers, and CRT-2s. If multiple MN alarms are present on the fire panel, the ACKNOWLEDGE/SCROLL DISPLAY key must be pressed for each alarm.
- To silence the panel sounder and any activated outputs that are programmed as silenceable:

Press the SIGNAL SILENCE key on a network control device. The FIRE ALARM LED and SIGNALS SILENCED LED light steady.

The control panel sends an Signal Silenced message to the remote annunciators, history buffer, installed printers, and CRT-2s. The figure below shows a sample Alarm Silenced message.

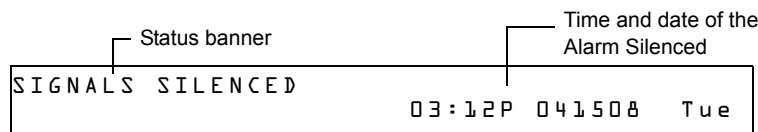

**Figure 3.5 Sample MN Alarm Silenced Message**

1. Correct the condition causing the MN alarm.
2. When you finish correcting the MN alarm condition, press the SYSTEM RESET key to return the control panel to normal operation (indicated by the “System Normal” message). The control panel sends a “System Normal” message to the LCD display, History buffer and installed printers, FDU-80 annunciators, and CRT-2s.

### 3.4.3 How the Control Panel Indicates a Mass Notification Supervisory

When an initiating device activates, the control panel does the following:

- Produces a warbling audible tone
- Activates any supervisory relays and devices programmed as Supervisory Pending, General Supervisory or General Pending
- Flashes the panel’s Supervisory LED
- Displays a Type Code that indicates the type of device that activated the MN supervisory
- Displays MN SUP in the status banner on the LCD display, along with information specific to the device, as shown below:

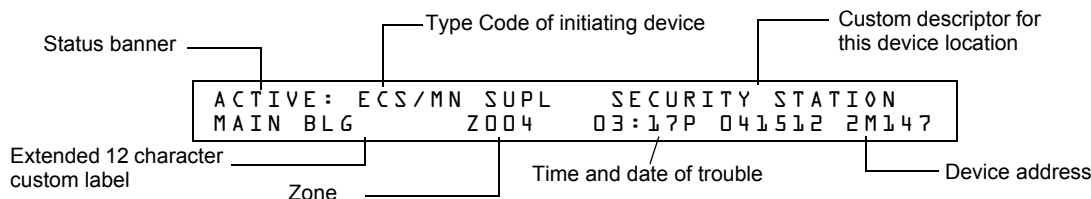

**Figure 3.6 Sample MN Supervisory Display**

- Sends an MN Supervisory message to the LCD display, remote annunciators, History buffer, installed printers, and CRT-2s.
- Initiates any Control-By-Event actions
- Activates special zone ZFE
- Sends an MN Supervisory message to the proprietary receiver via the network, if applicable

### 3.4.4 How to Respond to an MN Supervisory

If the control panel indicates an MN supervisory, you can do the following:

1. Press the ACKNOWLEDGE/SCROLL DISPLAY key to silence the panel sounder and switch the SUPERVISORY LED from flashing to steady. An Acknowledge message is sent to the remote annunciators, history buffer, installed printers, and CRTs. Pressing the ACKNOWLEDGE/SCROLL DISPLAY will acknowledge all MN supervisory events on the fire panel.
2. Correct the condition that activated the MN supervisory point.
3. For a Latching event, press the system reset key to return the control panel to normal operation. For a Non-latching event, the panel will return to normal operation once the supervisory condition is corrected.  
The control panel sends a “System Normal” message to the LCD display, History buffer and installed printers, remote annunciators, and CRT-2s.

### 3.4.5 How the Control Panel Indicates a Mass Notification Trouble

When an initiating device activates, the control panel does the following:

- Produces a pulsed audible tone
- Activates any trouble relays and devices programmed as Trouble Pending, General Trouble or General Pending
- Flashes the panel's Trouble LED
- Displays a Type Code that indicates the type of device that with a trouble
- Displays MN TBL in the status banner on the LCD display, along with information specific to the device, as shown below:

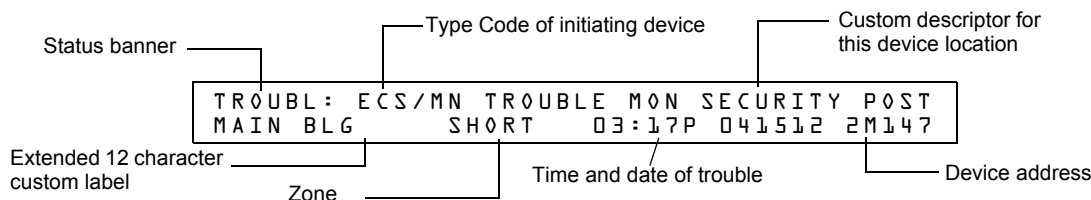

**Figure 3.7 Sample MN Trouble Display**

- Sends an MN trouble message to the LCD display, remote annunciators, History buffer, installed printers, and CRT-2s.
- Initiates any Control-By-Event actions
- Activates special zone ZFF
- Sends an MN Trouble message to the proprietary receiver via the network, if applicable

### 3.4.6 How to Respond to an MN Trouble

If the control panel indicates an MN trouble, you can do the following:

1. Press the ACKNOWLEDGE/SCROLL DISPLAY key to silence the panel sounder and switch the TROUBLE LED from flashing to steady. An Acknowledge message is sent to the remote annunciators, history buffer, installed printers, and CRTs. Pressing the ACKNOWLEDGE/SCROLL DISPLAY will acknowledge all MN trouble events on the fire panel.
2. Check the trouble message for location and type of trouble.
3. Correct the condition causing the trouble condition. If the trouble clears, the panel sends a Clear Trouble message to the History Buffer and installed printers, annunciators and CRT-2s. (troubles will clear from the fire panel even if they are not acknowledged.)
4. If no other events are present on the fire panel, a "System Normal" message is sent to the LCD display, remote annunciators, history buffer, installed printers, and CRT-2s and the fire panel returns to normal operation.

### 3.4.7 Interpreting MN Type Codes

The Type Code that displays in the fire panel message indicates the function of the point that initiates the activation. The table below lists the Type Codes that can appear in an mass notification message:

Type Code	Latching (Y/N)	Purpose	What it does
<b>Monitor Modules</b>			
ECS/MN MONITOR <sup>1</sup>	Y	Indicates activation of a mass notification device	Activates CBE, does not light any LEDs, overrides existing fire event <sup>2</sup> , shuts off silenceable outputs and all fire activated strobes
ECS/MN SUPL <sup>1</sup>	Y	Indicates activation of a mass notification device	Lights SUPERVISORY LED and activates CBE
ECS/MN SUPT	N	Indicates activation of a mass notification device	Lights SUPERVISORY LED and activates CBE
ECS/MN TROUBLE MON <sup>1</sup>	N	Indicates trouble on a mass notification device	Monitors mass notification devices. Will generate a trouble condition for both open and short conditions.
<sup>1</sup> This Type Code is not compatible with First Command applications.			

**Table 3.2 Mass Notification Type Codes**

## 3.5 System Trouble Mode of Operation

### 3.5.1 How the Control Panel Indicates a System Trouble

The system goes into system trouble when the control panel detects an electrical fault. If no fire alarms exist, the control panel does the following:

- Produces a pulsed audible tone
- Activates the Trouble relay (TB4)
- Flashes the SYSTEM TROUBLE LED
- Displays a Type Code that indicates the type of device with a trouble.
- Displays TROUBL in the status banner on the LCD display as well as the type of trouble and information specific to the device, as shown in Figure 3.8 below.
- Sends a Trouble message to the LCD display, remote annunciators, history buffer, installed printers, and CRT-2s.



**NOTE:** If a fire alarm exists when a trouble exists, the SYSTEM TROUBLE LED lights, but the Alarm message appears in the LCD display.

Typical Trouble message that appears on the LCD display:

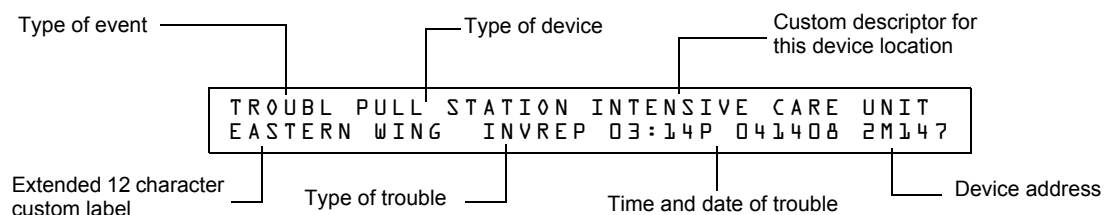

**Figure 3.8 Sample Trouble Message**

### 3.5.2 How to Respond to a System Trouble

If the control panel indicates a trouble, you can do the following:

1. Press the ACKNOWLEDGE/SCROLL DISPLAY key to silence the panel sounder and switch the SYSTEM TROUBLE LED from flashing to steady—regardless of the number of troubles, alarms, security and supervisory signals.



**NOTE:** Pressing the SIGNAL SILENCE key when only troubles exist, gives the same result as pressing the ACKNOWLEDGE/SCROLL DISPLAY key. The SIGNALS SILENCED LED does not light unless an alarm exists in the system.

2. The control panel sends an Acknowledge message to the remote annunciators, history buffer, installed printers, and CRT-2s.

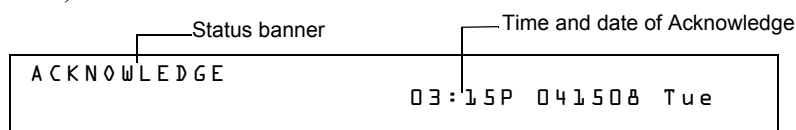

**Figure 3.9 Sample Acknowledge Message**

3. Check the trouble message for the location and type of trouble.

```

TROUBL MONITOR      MODULE ADDRESS  M021 Z00 OPEN CIRCUIT  08:10A 042108 2M021
TROUBL MONITOR      MODULE ADDRESS  M022 Z00 OPEN CIRCUIT  08:12A 042108 2M022
    
```

**Figure 3.10 Sample Trouble Messages on CRT-2 or Printer**

4. Correct the condition causing the trouble. If the trouble clears, the control panel sends a Clear Trouble message to the History buffer and installed printers FDU-80 annunciators, and CRT-2s.

If all troubles clear and no supervisory signals or fire alarms exist, the control panel does the following:

- Returns to Normal operation (indicated by the “System Normal” message)
- Sends a “System Normal” message to the LCD display, History buffer and installed printers, FDU-80 annunciators, and CRT-2s
- Restores troubles automatically - even if troubles are not acknowledged

If multiple trouble conditions exist in the system, the LCD and optional CRT-2 and FDU-80s automatically step through each trouble every 3 seconds in the following order:

1. Alarms, in order of address
2. Supervisory, in order of address
3. Troubles, in order of address

Press the ACKNOWLEDGE/SCROLL DISPLAY key and the display stops on the current trouble event for 1 minute, then begins to automatically step through remaining troubles. To manually step through remaining troubles, press the ACKNOWLEDGE/SCROLL DISPLAY key.

Refer to Appendix D, “Point and System Troubles Lists”, on page 72 for explanations of troubles that appear on the display.



## 3.6 Security Alarm Mode of Operation

### 3.6.1 How the Control Panel Indicates a Security Alarm

The system goes into Security mode when a monitor module point programmed with a Security Type Code activates. If no fire alarm exists, the control panel does the following:

- Produces a warbling audible tone
- Turns on the Security relay (TB5)
- Flashes the SECURITY LED (blue)
- Displays a Type Code that indicates the type of security alarm being generated
- Displays ACTIVE in the status banner on the control panel, along with information specific to the device
- Sends a Security message to the LCD display, remote annunciators, history buffer, installed printers, and CRT-2s.
- Sends a Security message to the proprietary receiver via the network, if applicable.



**NOTE:** If a fire alarm exists, and there are silenced alarms (the SIGNALS SILENCED LED is lighted), a Security alarm will resound the panel sounder.

A Typical security message that appears on LCD display:

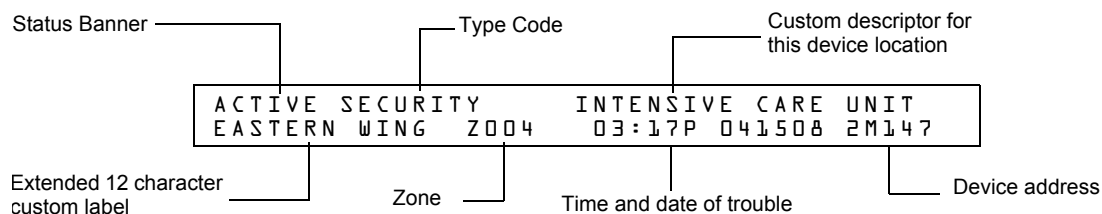

**Figure 3.11 Sample Security Alarm Message**

### 3.6.2 How to Respond to a Security Alarm

A Security Type Code latches the control panel. To return the control panel to normal operation, you must correct the condition causing the security condition, then reset the control panel. If the control panel indicates a security alarm, take the following action:



**NOTE:** If a fire alarm exists, and there are silenced alarms (the SIGNALS SILENCED LED is lighted), a Security alarm will resound the panel sounder.

1. Press the ACKNOWLEDGE/SCROLL display key to silence the panel sounder and switch the SECURITY LED from flashing to steady—regardless of the number of troubles, alarms, supervisory, and security signals. The control panel sends a Security message to the remote annunciators, history buffer, installed printers, and CRT-2s.
2. Correct the condition that activated the Security point.
3. When you finish correcting the Security condition, press the SYSTEM RESET key to return the control panel to normal operation (indicated by the “System Normal” message). The control panel sends a “System Normal” message to the LCD display, remote annunciators, history buffer, installed printers, and CRT-2s.

### 3.6.3 Interpreting Security Type Codes

The Type Code that displays in the security alarm message indicates the type of security alarm being generated by the monitor module that initiates the alarm. For example, a monitor module with a Type Code of AREA MONITOR indicates an intruder in a protected premises area. The table below lists the Type Codes that can appear in a security alarm message.

<b>Monitor Modules</b>			
Type Code	Latching (Y/N)	Purpose	What it does
AREA MONITOR	Y	Monitors area surveillance equipment, such as motion detectors	Lights SECURITY LED, activates CBE
SECURITY	Y	Monitors security switches for tampering	Lights SECURITY LED, activates CBE
SYS MONITOR	Y	Monitors critical equipment for security	Lights SECURITY LED, activates CBE

**Table 3.3 Security Type Codes**

## 3.7 Active Supervisory Signal Mode of Operation

### 3.7.1 How the Control Panel Indicates an Active Supervisory

The system goes into Supervisory mode when a monitor module point programmed with a Supervisory type code activates. When a Supervisory point activates, the control panel does the following:

- Produces a warbling audible tone
- Turns on the Supervisory relay (TB5)
- Flashes the SUPERVISORY LED (yellow)
- Displays one of the Type Codes listed in Table 3.4.
- Displays ACTIVE in the status banner on the control panel, along with information specific to the device
- Sends a Supervisory message to the LCD display, remote annunciators, history buffer, installed printers, and CRT-2s.



**NOTE:** If a fire alarm exists, and there are silenced alarms (the SIGNALS SILENCED LED is lighted), a Supervisory alarm will resound the panel sounder.

A Typical Supervisory message that appears on LCD display:

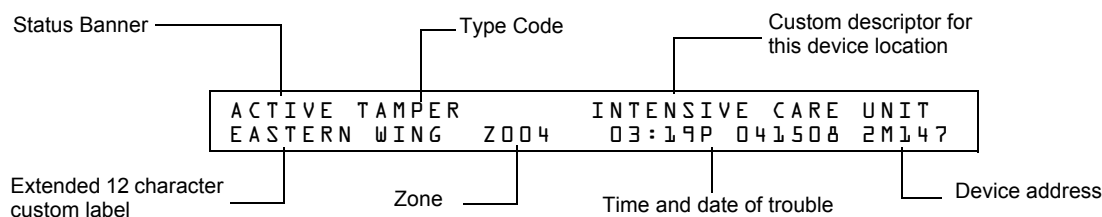

**Figure 3.12 Sample Supervisory Signal Message**

## 3.7.2 How to Respond to an Active Supervisory

### If a Latching Supervisory Type Code Displays

Some Supervisory Type Codes latch the control panel (Refer to Table 3.4 for a list of these type codes). To return the control panel to normal operation, you must correct the condition causing the supervisory condition, then reset the control panel. Take the following action:



---

**NOTE:** If a fire alarm exists, and there are silenced alarms (the SIGNALS SILENCED LED is lighted), a Supervisory alarm will resound the panel sounder.

---

1. Press the ACKNOWLEDGE/SCROLL DISPLAY key to silence the panel sounder and switch the SUPERVISORY LED from flashing to steady—regardless of the number of troubles, alarms, and supervisory signals. The control panel sends a Supervisory message to the remote annunciators, history buffer, installed printers, and CRT-2s.
2. Correct the condition that activated the supervisory point.
3. When you finish correcting the latching supervisory condition, press the SYSTEM RESET key to return the control panel to normal operation (indicated by the “System Normal” message). The control panel sends a “System Normal” message to the LCD display, remote annunciators, history buffer, installed printers, and CRT-2s.

### If Non-latching Type Code Displays

Some Supervisory Type Codes do not latch the control panel. (Refer to Table 3.4 for a list of these type codes). The control panel automatically returns to normal operation, when you correct the condition that activates the supervisory point. If the control panel indicates a non-latching supervisory point, take the following action:



---

**NOTE:** If a fire alarm exists, and there are silenced alarms (the SIGNALS SILENCED LED is lighted), a Supervisory alarm will resound the panel sounder.

---

1. Press the ACKNOWLEDGE/SCROLL DISPLAY key to silence the panel sounder and switch the SUPERVISORY LED from flashing to steady—regardless of the number of troubles, alarms, and supervisory signals. The control panel sends a Supervisory message to the remote annunciators, history buffer, installed printers, and CRT-2s.
2. Correct the condition that activated the supervisory point.
3. The control panel automatically returns to normal operation (indicated by the “System Normal” message) and the control panel sends a “System Normal” message to the LCD display, remote annunciators, history buffer, installed printers, and CRT-2s.

## 3.7.3 How to Interpret Supervisory Type Codes

The Type Code that displays in the Supervisory message indicates the function of the point that initiates the Supervisory. For example, a monitor module with a TAMPER Type Code means that the monitor module connects to a tamper switch.

Type Codes that can appear in an Supervisory message:

<b>Monitor Modules</b>			
<b>Type Code</b>	<b>Latching (Y/N)</b>	<b>Purpose</b>	<b>What it does</b>
WATERFLOW S	Y	Indicates supervisory condition for activated waterflow switch	Lights SUPERVISORY LED and activates CBE
RF SUPERVSRY	N	Monitors a radio frequency device	Lights SUPERVISORY LED and activates CBE
LATCH SUPERV	Y	Indicates latching supervisory condition	Lights SUPERVISORY LED and activates CBE
TRACK SUPERV	N	Indicates tracking supervisory condition	Lights SUPERVISORY LED and activates CBE
SPRINKLR SYS	Y	Indicates activation of sprinkler system	Lights SUPERVISORY LED and activates CBE
TAMPER	Y	Indicates activation of tamper switch	Lights SUPERVISORY LED and activates CBE
<b>Detectors</b>			
SUP.T(DUCTI)	N	Ion detector that indicates supervisory (non-alarm) condition	Lights SUPERVISORY LED and activates CBE
SUP.L(DUCTI)	Y	Ion detector that indicates supervisory (non-alarm) condition	Lights SUPERVISORY LED and activates CBE
SUPT(DUCTL)	N	Laser detector that indicates supervisory (non-alarm) condition	Lights SUPERVISORY LED and activates CBE
SUPL(DUCTL)	Y	Laser detector that indicates supervisory (non-alarm) condition	Lights SUPERVISORY LED and activates CBE
SUP.T(DUCTP)	N	Photo detector that indicates supervisory (non-alarm) condition	Lights SUPERVISORY LED and activates CBE
SUP.L(DUCTP)	Y	Photo detector that indicates supervisory (non-alarm) condition	Lights SUPERVISORY LED and activates CBE
SUPT(PHOTO)	N	Photo detector that indicates supervisory (non-alarm) condition	Lights SUPERVISORY LED and activates CBE
SUP.L(PHOTO)	Y	Photo detector that indicates supervisory (non-alarm) condition	Lights SUPERVISORY LED and activates CBE
SUP.T(ION)	N	Ion detector that indicates supervisory (non-alarm) condition	Lights SUPERVISORY LED and activates CBE
SUP.L(ION)	Y	Ion detector that indicates supervisory (non-alarm) condition	Lights SUPERVISORY LED and activates CBE
SUP.L(LASER)	Y	Laser detector that indicates supervisory (non-alarm) condition	Lights SUPERVISORY LED and activates CBE
SUP.T(LASER)	N	Laser detector that indicates supervisory (non-alarm) condition	Lights SUPERVISORY LED and activates CBE
PHOTO/CO (C SUP)*	Y	Indicates activation of the Photo, Heat or CO element of a detector.	Activation of the Heat or Photo elements will light an indicator at the control panel. Activation of the CO element will light the SUPERVISORY LED. Activates CBE.
PHOTO/CO (P SUP)*	Y	Indicates activation of the Photo, Heat or CO element of a detector.	Activation of the Heat element will light an indicator at the control panel. Activation of the CO element will not light and indicator at the control panel. Activation of the Photo element will light the SUPERVISORY LED. Activates CBE.
*FlashScan only			

Table 3.4 Supervisory Type Codes

## 3.8 Pre-Alarm Warning Mode of Operation

### 3.8.1 How the Control Panel Indicates a Pre-Alarm Warning

The control panel activates a Pre-Alarm Warning if a detector exceeds the programmed Pre-Alarm Alert or Action level. When a detector activates a Pre-Alarm, the control panel does the following:

- Pulses the panel sounder
- Flashes the PRE-ALARM LED
- Activates the Pre-Alarm zone (F9)
- Sends a Pre-Alarm message to the LCD display, History buffer and installed printers, FDU-80 annunciators, and CRT-2s
- Displays a PREALARM status banner, the Type Code of the detector, and the Pre-Alarm level (Alert or Action) on the LCD display, along with information specific to the device as shown in Figure 3.13.

### 3.8.2 How to Respond to a Pre-Alarm Warning

#### Pre-Alarm Alert and Action Levels

The Pre-Alarm function is a programmable option which determines the system’s response to real-time detector sensing values above the programmed setting. Use the Pre-Alarm function if you want to get an early warning of incipient or potential fire conditions. The Pre-Alarm function provides one of two levels of Pre-Alarm as follows:



**NOTE:** For detailed information on Pre-Alarm applications, refer to the *NFS2-640 Programming Manual*.

- Alert – a non-latching condition that causes a Pre-Alarm when a detector reaches the programmed Pre-Alarm level.
- Action – a latching condition that causes a Pre-Alarm when a detector reaches the programmed Pre-Alarm level.

#### Responding to a Pre-Alarm Warning

The Pre-Alarm screen display is the same for both alert and action conditions. Following is a sample screen for a Pre-Alarm message.

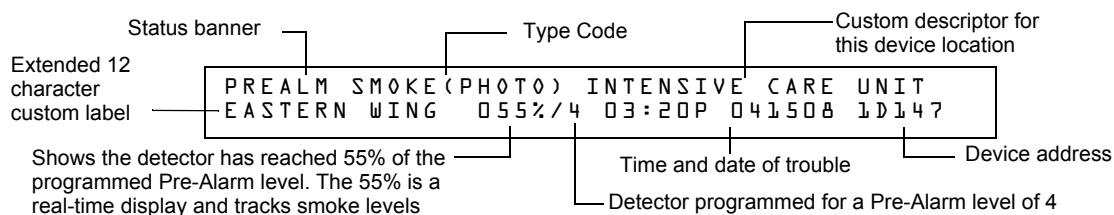

**Figure 3.13 Sample of an Alert Pre-Alarm Message**

An Alert Pre-Alarm automatically restores to normal when the detector sensitivity, programmable to one of nine settings, drops below the programmed Alert level. Zone F09 automatically clears when no Pre-Alarm conditions exist.

An Action Pre-Alarm latches until you reset the system - even if the detector sensitivity drops below the Action level. Zone F09 activates - but Zone Z00 (general alarm) and the trouble and alarm relays do not activate. The fifth zone programmed, not the first four, in the detector’s CBE activates. A subsequent alarm condition for this detector clears the Action indication from the LCD display.

#### Interpreting Pre-Alarm Type Codes

The Type Code that displays in the Pre-Alarm warning indicates the function of the point that initiates the Pre-Alarm warning. Refer to the Detectors section of Table 3.1 for the Type Codes that can appear in a Pre-Alarm warning, and for descriptions of those Type Codes.

### 3.9 Disabled Points Mode of Operation

The control panel indicates disabled points by displaying a screen for each disabled detector, monitor module, and control/relay module. Disabled points do not cause an alarm or any Control-by-Event activity. If more than one point is disabled, the control panel displays by priority, mimicking the alarms.



**CAUTION:**  
**DISABLING A ZONE DISABLES ALL INPUT AND OUTPUT DEVICES ASSOCIATED WITH THE ZONE.**

When one or more points are disabled, the control panel does the following:

- Holds all disabled output points in the off-state
- Flashes the SYSTEM TROUBLE LED
- Lights the POINT DISABLED LED
- Sends a Disabled Point message to the LCD display, History buffer and installed printers, FDU-80 annunciators, and CRT-2s
- Displays a message for each disabled point

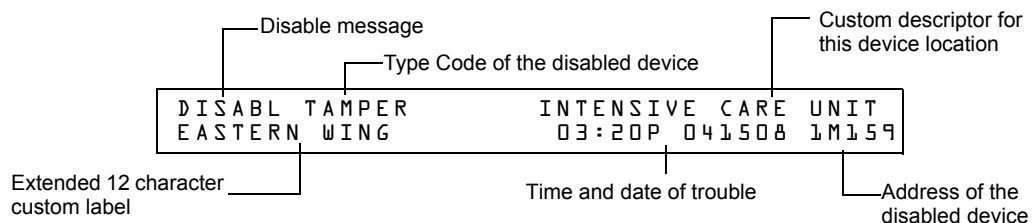

Figure 3.14 Sample Disabled Point Message

### 3.10 Non-Alarm Mode of Operation

#### 3.10.1 Purpose of Non-Alarm Points

Non-Alarm points are addressable monitor modules programmed with one of the Non-Alarm Type Codes listed in Table 3.5. Non-Alarm points, except Non-Fire, operate like monitored system functions that can produce troubles—but with the differences shown in the following sections.

<b>Monitor Modules</b>			
Type Code	Latching (Y/N)	Purpose	What it does
ACCESS MONTR	N	Used for monitoring building access	Activates CBE
ACK SWITCH	N	Performs Acknowledge function	Silences panel sounder, gives an Acknowledge message on the panel LCD
ALLCALL PAGE	N	Activates all speaker circuits for paging	Activates speakers
DRILL SWITCH	N	Performs Drill function	Activates silenceable outputs
FIRE CONTROL	N	Used for air handler shutdown, intended to override normal operating automatic functions	Activates CBE, does NOT light an indicator at the control panel
NON-FIRE	N	Used for energy management or other non-fire situations. Does not affect operation of the control panel	Activates CBE, does NOT light an indicator at the control panel
PAS INHIBIT	N	Inhibits Positive Alarm Sequence	Inhibits Positive Alarm Sequence
RESET SWITCH	N	Performs Reset function	Resets control panel
SIL SWITCH	N	Performs Signal Silence function	Turns off all activated silenceable outputs
TELE PAGE	N	Performs function of Page Button on FFT-7	Allows remote paging to a fire area

Table 3.5 Non-Alarm Type Codes (1 of 2)

ABORT SWITCH	N	Indicates Active at the panel	Aborts activation of a releasing zone
--------------	---	-------------------------------	---------------------------------------

**Table 3.5 Non-Alarm Type Codes (2 of 2)**

### 3.10.2 How the Control Panel Indicates an Active Fire Control

Activation of a FIRE CONTROL point causes the control panel to do the following:

- Initiate the monitor module Control-by-Event
- Send a message to the LCD display, History buffer and installed printers, FDU-80 annunciators, and CRT-2s
- Display an ACTIVE status banner and FIRE CONTROL Type Code on the LCD display, along with information specific to the device

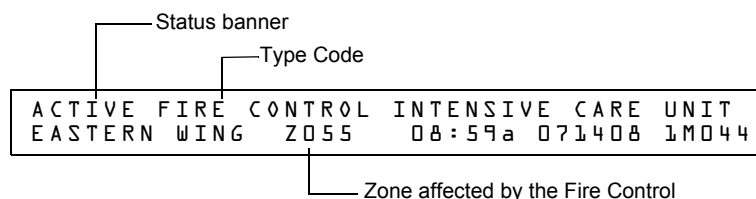

**Figure 3.15 Sample Fire Control Point Display**

### 3.10.3 How the Control Panel Indicates an Active Non-Fire Point

Non-Fire point operation does not affect control panel operation, nor does it display a message at the panel LCD. Activation of a Non-Fire point activates CBE—but does not cause any indication on the control panel. For example, you can program a Non-Fire point to turn lights in a zone to a lower setting when activated. In this case, when the point activates the control panel activates the point's CBE to turn the lights down without any audio or visual indication on the control panel.

## 3.11 CO Alarm Mode of Operation

### 3.11.1 How the Control Panel Indicates a CO Alarm

When an initiating device (detector or monitor module) activates due to a CO alarm event, the control panel does the following:

- Produces a pulsed audible tone
- Displays a CO alarm event that indicates the type of device that activated the fire alarm
- Displays ALARM in the status banner on the LCD display, along with information specific to the device, as shown below:

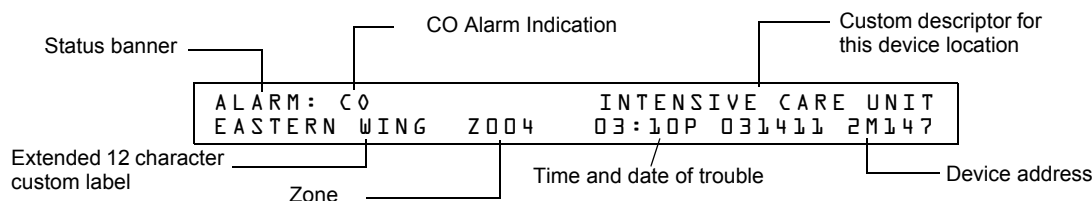

**Figure 3.16 Sample CO Alarm Display**

- Sends a CO Alarm message to the LCD display, remote annunciators, History buffer, installed printers, and CRT-2s.
- Latches the control panel in CO alarm. (You can not return the control panel to normal operation until you correct the CO alarm condition and reset the control panel)
- Initiates any Control-By-Event actions—activates ZFC.

### 3.11.2 How to Respond to a CO Alarm

If the control panel indicates a CO alarm, you can do the following:

- To silence only the panel sounder:  
Press the ACKNOWLEDGE/SCROLL DISPLAY key. The local sounder will silence.  
The control panel will send an acknowledge message to the LCD display, remote annunciators, history buffer, installed printers, and CRT-2s.
- To silence the panel sounder and any activated outputs that are programmed as silenceable:  
Press the SIGNAL SILENCE key. The SIGNALS SILENCED LED will light steady.  
The control panel sends a Signal Silenced message to the remote annunciators, history buffer, installed printers, and CRT-2s. The figure below shows a sample Alarm Silenced message.

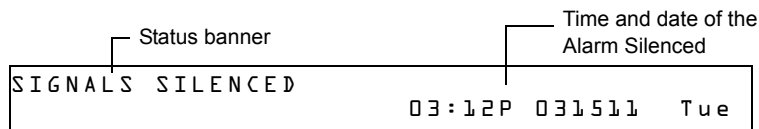

**Figure 3.17 Sample Alarm Silenced Message**

1. Check the Alarm message for the location and type of trouble.
2. Correct the condition causing the CO alarm.
3. When you finish correcting the CO alarm condition, press the SYSTEM RESET key to return the control panel to normal operation (indicated by the “System Normal” message). The control panel sends a “System Normal” message to the LCD display, History buffer and installed printers, FDU-80 annunciators, and CRT-2s.

### 3.11.3 Interpreting CO Alarm/Supervisory Type Codes

The Type Code that displays in the CO Alarm message indicates the function of the point that initiates the CO alarm. For example, a monitor module with a CO MONITOR Type Code means that the monitor module monitors a conventional CO detector. The table below lists the Type Codes that can appear in an alarm message:

Type Code	Latching (Y/N)	Purpose	What it does
<b>Monitor Modules</b>			
CO Monitor*	Y	Indicates activation of a CO conventional detector	Activates CBE, does not light an indicator at the control panel.
<b>Detectors</b>			
PHOTO/CO*	Y	Indicates activation of the Photo, Heat, or CO element of a detector.	Lights FIRE ALARM LED for photo and heat, no LED will light for a CO alarm. Photo and heat will activate CBE, CO alarm activates special function zone FC and sixth CBE zone only (sixth CBE zone programmable via VeriFire Tools)
PHOTO/CO (P SUP)*	Y	Indicates activation of the Photo, Heat or CO element of a detector.	Lights FIRE ALARM LED for heat, no LED will light for a CO alarm, supervisory LED will light for photo alarm, heat and photo will activate CBE, CO alarm activates special function zone FC and sixth CBE zone only (sixth CBE zone programmable via VeriFire Tools)

**Table 3.6 CO Alarm Type Codes (1 of 2)**



Type Code	Latching (Y/N)	Purpose	What it does
PHOTO/CO (C SUP)*	Y	Indicates activation of the Photo, Heat or CO element of a detector.	Lights FIRE ALARM LED for heat and photo alarms, will light supervisory LED for CO alarm, photo and heat alarms will activate CBE, CO alarm will activate sixth CBE zone only (sixth CBE zone programmable via VeriFire Tools)

\*FlashScan mode only

Table 3.6 CO Alarm Type Codes (2 of 2)

## 3.12 Active Trouble Monitor Mode of Operation

### 3.12.1 How the Control Panel Indicates an Active Trouble Monitor

Trouble Monitor Points are monitor modules programmed with the following Type Codes:

Type Code	Latching (Y/N)	Device Function	Point Function
AUDIO SYSTEM	N	Used for monitoring audio equipment audio amplifiers or associated equipment	Indicates trouble
EQUIP MONITR	N	Used for recording access to monitored equipment	Activates CBE
POWER MONITR	N	Used to monitor remote power supplies or other external equipment	Indicates trouble
TROUBLE MON	N	Used to monitor remote power supplies or other external equipment	Indicates trouble

Table 3.7 Trouble Monitor Type Codes

These types of monitor modules operate like monitored system functions that can produce troubles—but with the following differences:

- The LCD display status banner displays ACTIVE as shown:

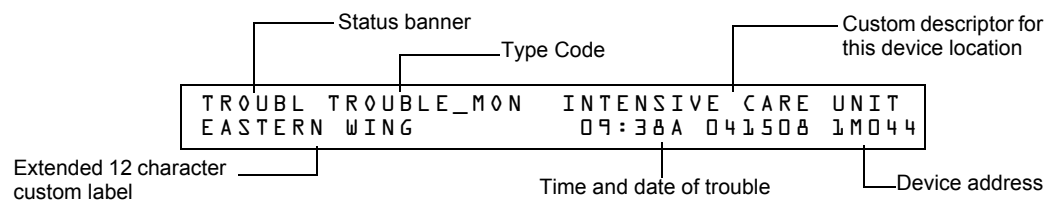

Figure 4 Sample Trouble Monitor Point Message

- The monitor module is non-latching: the module will return to normal when the trouble condition no longer exists.
- The monitor modules activate Control-by-Event
- The panel trouble relay transfers (TB4)

### 3.12.2 How to Respond to an Active Trouble Monitor

If the control panel indicates an active Trouble Monitor Point, take the following action:

- Press the ACKNOWLEDGE/SCROLL DISPLAY key to silence the panel sounder and switch the SYSTEM TROUBLE LED from flashing to steady—regardless of the number of troubles, alarms, and supervisory signals.
- The control panel sends an Acknowledge message to the History buffer and installed printers, FDU-80 annunciators, and CRT-2s. Check the trouble message for the location and type of trouble.
- Correct the condition causing the trouble.

4. When the trouble condition is corrected, the panel will return to normal operation (indicated by the “System Normal” message).
5. The control panel sends a “System Normal” message to the LCD display, History buffer and installed printers, FDU-80 annunciators, and CRT-2s.

## 3.13 Output Circuit Trouble Mode of Operation

### 3.13.1 Overview

Output circuits include NACs, Control/Relay Modules, and Transponder Points. This section contains a description of control panel operation for each type of output circuit.

- Four NACs are included on the control panel
- Control/Relay Modules connected to the control panel on an SLC
- Transponder Points: XPC-8 (CLIP only), or XP6-C (CLIP or FlashScan)

<b>Trouble Type Codes for Control Modules and NAC Circuits</b>			
<b>Type Code</b>	<b>Silenceable (Y/N)</b>	<b>Configuration</b>	<b>Device Function</b>
CONTROL	N	NAC	Supervised NAC
RELAY	N	FORM-C relay	Relay Output
BELL CIRCUIT	N	NAC	Supervised NAC for notification appliance
STROBE CKT	N	NAC	Supervised NAC for notification appliance
HORN CIRCUIT	N	NAC	Supervised NAC for notification appliance
AUDIBLE CKT	N	NAC	Supervised NAC for notification appliance
SPEAKER	N	NAC	Supervised NAC for speaker circuit
REL END BELL	N	NAC	Supervised NAC for notification appliance
blank	N	NAC	Supervised NAC for undefined device
RELEASE CKT	N	NAC	Directs outputs to perform a releasing function.
REL CKT ULC	N	NAC	Directs outputs to perform a release function as required by ULC.
REL AUDIBLE	N	NAC	NAC, activated upon release
NONRESET CTL*	N	NAC	Relay output, unaffected by “System Reset” command
TELEPHONE	N	NAC	Standard Telephone circuit
REL CODE BELL**	N	NAC	Supervised NAC (NFS2-640 NAC only)
INSTANT RELE	N	NAC	NAC, short = normal; supervised for open circuits and ground faults. Always non-silenceable and switch-inhibited.
ALARMS PEND	N	NAC	Output that will activate upon receipt of an alarm condition, and remain in the alarm state until all alarms have been acknowledged.
CONTROL NAC**	N	NAC	Supervised NAC
GEN ALARM	Y		Control Module, an XPC-8 circuit, or an XP6-C configured as a Municipal Box Transmitter for NFPA 72 Auxiliary Fire Alarm Systems application. This Type ID can also be used for general alarm activation.
GEN SUPERVIS	Y		Control Module, an XPR-8 relay, or an XP6-R activated under any Supervisory condition (includes sprinkler type).
GEN TROUBLE	Y		Control Module, an XPR-8 relay, or an XP6-R activated under any System Trouble condition.
GENERAL PEND	Y		Control Module, an XPC-8 circuit, or an XP6-C that will activate upon receipt of an alarm and/or trouble condition, and remain in the ON state until all events have been ACKNOWLEDGED.
TROUBLE PEND	N		Control Module, an XPC-8 circuit, or an XP6-C that will activate upon receipt of a trouble condition, and remain in the ON state until all troubles have been ACKNOWLEDGED.
MNS GENERAL <sup>1</sup>	N	NAC	Mass Notification supervised output
MNS CONTROL <sup>1</sup>	N	NAC	Mass Notification supervised output

**Table 3.8 Control Module and NAC Circuit Trouble Type Codes (1 of 2)**



2. The control panel sends an Acknowledge message to the History buffer and installed printers, FDU-80 annunciators, and CRT-2s. Check the trouble message for the location and type of trouble.
3. Correct the condition causing the trouble.
4. When the trouble condition is corrected, the panel will return to normal operation (indicated by the “System Normal” message).
5. The control panel sends a “System Normal” message to the LCD display, History buffer and installed printers, FDU-80 annunciators, and CRT-2s.

## 3.14 Operation of Special System Timers

### 3.14.1 What are System Timers?

There are user-programmable time delays for three specific functions: the Auto Silence Timer, the Alarm Verification Timer, and the Silence Inhibit Timer. Figure 3.3 shows a sample System Function Selection screen with system timer settings. For instructions on changing system functions, refer to the *NFS2-640 Programming Manual*.

### 3.14.2 How to View System Timer Selections

You can use the Read Status Entry option (explained in Chapter 4) to view the current selection for the System Timers. To do so, press the keys shown below in sequence:



The LCD display shows the current selections for System Functions, which includes the three system timers.

Sample LCD display of a System Function screen with system timer selections:

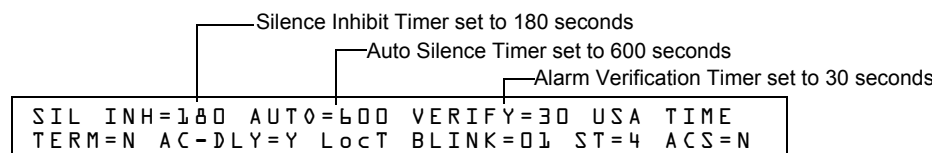

Figure 3.3 Sample System Function Selection Screen

### 3.14.3 How System Timers Work

The control panel can operate with special system timers: Auto Silence Timer, Alarm Verification Timer and Silence Inhibit Timer.

#### Auto Silence Timer

A timer that functions like pressing the SIGNAL SILENCE key. When the Auto Silence Timer reaches its programmed value (600-900 seconds), the control panel automatically shuts off all active outputs programmed as silenceable.

#### Alarm Verification Timer

A timer that directs the control panel to ignore a fire alarm for a smoke detector, programmed for Alarm Verification, while the Alarm Verification Timer is counting. Table 3.9 contains a summary of how the Alarm Verification Timer works.

If	The control panel does this
A second fire alarm occurs while the Alarm Verification Timer is counting	ignores the Alarm Verification Timer

Table 3.9 Alarm Verification Timer Operation

If	The control panel does this
The Alarm Verification Timer elapses and a fire alarm still exists	Activates the fire alarm
The Alarm Verification Timer expires and a fire alarm no longer exists	Increments the Alarm Verification counter (up to 99) for the device and returns to normal operation

**Table 3.9 Alarm Verification Timer Operation**

### Silence Inhibit Timer

A timer that disables the SIGNAL SILENCE key function and inhibits reset during countdown for the programmed time (0-300 seconds) when a fire alarm occurs. A Silence Inhibit Timer starts at the first fire alarm. Subsequent alarms will not restart the timer until the alarm condition is completely resolved and a panel reset is performed.

## 3.15 Waterflow Circuit Operation

If a monitor module programmed with a WATERFLOW Type Code initiates a fire alarm, the control panel disables the SIGNAL SILENCE key and the Auto Silence Timer. Refer to the *NFS2-640 Installation Manual* for information on Waterflow circuits.



---

**NOTE:** In firmware version 18.x (or higher), silenceable outputs activated from a WATERFLOW type code activation can be silenced if the silenceable waterflow option is enabled via VeriFire Tools.

---

## 3.16 Style 6 and Style 7 Operation

Style 6 and Style 7 are supervised methods of communicating with addressable devices. If the control panel detects a trouble (open or short), it will attempt to drive both ends of the loop, maintaining communication in an unsupervised method. The trouble will display on the panel as a Style 6 trouble until you correct the condition. Style 7 configuration of the SLC requires the use of ISO-X isolator modules.

# Section 4: Read Status Operation

## 4.1 Introduction

This section contains instructions and sample screens to show how to access all Read Status functions and menus. For information on Read Status using a CRT-2 refer to “Remote Terminal Access” on page 64.

## 4.2 What is Read Status?

Read Status is a control panel function that lets you view system program information—but not change any programmed settings. The Read Status function lets you do the following:

- View Read Status information without entering a password.
- Enter and operate Read Status functions while the control panel provides full fire protection.
- View Read Status information while a fire alarm or trouble condition exists.



---

**NOTE:** If a fire alarm or trouble occurs while you are in Read Status, the control panel automatically exits Read Status operation and displays the new fire alarm or trouble.

---

### 4.2.1 Quick Reference Key Sequences



For quick reference, in the left margin next to each Read Status option is a block that shows the key sequence needed to view that option.



For example, the block to the left shows how to display the “Read Point” screen:

## 4.3 Entering Read Status

To enter Read Status, follow these steps:

1. From the “System Normal” screen, press the ENTER key. The control panel displays the “Entry” screen as shown below;

```
1 = PROGRAMMING      2 = READ STATUS ENTRY
(ESCAPE TO ABORT)
```

2. From the “Entry” screen, press the 2 key. The control panel displays the “Read Status Options” screen as shown below:

```
READ POINT=0 HIST=2 ALARM HIST=4 <ENTER>
PRNT POINT=1 HIST=3 ALARM HIST=5 <ENTER>
```

## 4.4 Viewing and Printing a Read Status

To view or print Read Status information follow the instructions below:

Option	Press	Lets you
Read Point	0 key, ENTER key	View information for a detector, module, NAC or zone
Print Points	1 key, ENTER key	Print information for all installed points in the system
Read History	2 key, ENTER key	Display the total number of events in the History buffer and step through each event in sequence
Print History	3 key, ENTER key	Print the contents of the History buffer (up to 800 events)
Read Alarm History	4 key, ENTER key	View a display of the number of alarms in the Alarm History buffer, then scroll through each alarm event
Print Alarm History	5 key, ENTER key	Print the contents of the Alarm History buffer (up to 200 events)



**NOTE:** If attempting to read a point that is not installed, the control panel displays “Not Installed”.

During all Read Status operations (except print operations) the control panel starts a 2-minute timer each time you press a key. If the control panel does not detect a key press for 2 minutes, the control panel exits Read Status and returns to the “System Normal” display.

In Read Status, you can also do the following:

- Press the ESC key to delete the previous entry.
- Press the SYSTEM RESET key to abort Read Status.

### 4.4.1 How to View Read Status of Devices, Zones, & System Settings

#### Overview

Read Point options 0, 2, and 4 in the Read Status Screen let you display and view information for devices and zones programmed into the control panel, as well as view system and annunciator settings. This section provides instructions and sample displays so you can view Read Status.

Topics covered in this section:

To view Read Status for	Refer to
Intelligent Detectors	“How to View Read Status for a Detector” on page 40
Control/relay and Monitor modules	“How to View Read Status for a Control/Relay or Monitor Module” on page 41
NAC	“How to View Read Status for a NAC” on page 42
Software Zones (Z01-Z99)	“How to View Read Status for a Software Zone (Z01-Z99)” on page 43
Special Zones (F0-F9, FA- FC)	“How to View Read Status for a Special Zone (F0-F9, FA-FC)” on page 43
Releasing Zones (R0-R9)	“How to View Read Status for a Releasing Zone (R0-R9)” on page 44
System Functions	“How to Read Status for System Functions” on page 44
Annunciator Selections	“How to Read Status for Annunciator Selections” on page 45

### How to Display the Total of Installed Devices

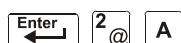

To view the total number of installed devices, enter the “Read Status” screen by pressing the ENTER key, then 2, then A. A screen similar to the following will appear:

```
L1:159Dets, 159Mods  L2:055Dets, 047Mods
Panel Outputs: 64  Bells: 04
SB L1:000          SB L2:000
```

### How to Display a Point or Zone for Read Status



From the “Read Status” screen, press 0, then press the ENTER key to display the “Read Point Entry” screen as shown below:

```
ZONE=Z,AA,E      DETECTOR=#,L,AAA,E
MODULE=#,L,MAA,E  OUTPUT CKT=B,AA,E
```

- To view a detector, press DETECTOR **\***, SLC number, detector SLC address, ENTER.
- To view a zone, press **Z**, zone number, ENTER.
- To view a monitor or control/relay module, press MODULE **#**, SLC number, module SLC address, ENTER.
- To view a NAC, press OUTPUT **&**, two-digit address, (for example 01 for B01, etc.), ENTER.

When you select a device or a zone, the control panel displays information for the device or zone, but does not send this information to the serial ports or the History buffer.

### How to View Read Status for a Detector

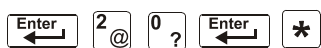

SLC number followed by three digit address

- +** next device
- previous device

From the “Read Status” screen, press 0, then press the ENTER key. You can now view Read Status for a detector as follows: press DETECTOR, enter the SLC number followed by the three digit address, then press the ENTER key. For example, to read the status of detector 1D002: press DETECTOR, enter the SLC number (1), enter address 002, then press the ENTER key. The control panel now displays information about the detector, as shown in Figure 4.1.

The display and descriptions of the fields are shown below:

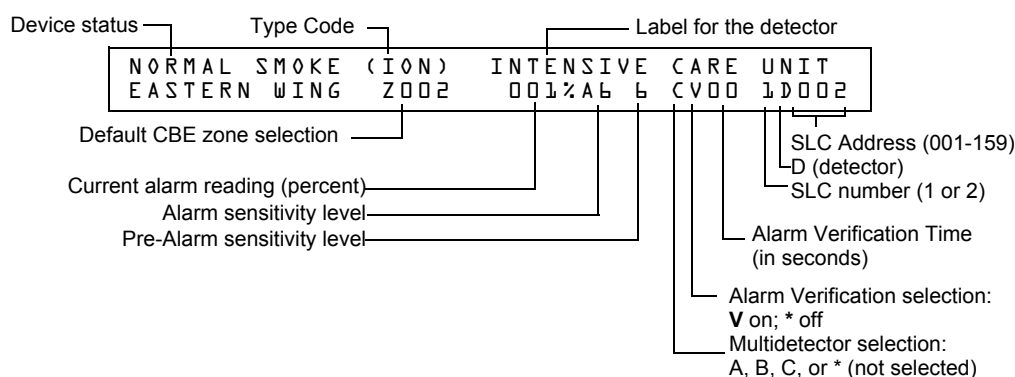

Figure 4.1 Sample Detector Read Status Display



- **Device Status** The status of the detector: Normal, Alarm, or Test.
- **Type Code** The software Type Code that identifies the type of detector. (Refer to “Point Programming” in the *NFS2-640 Programming Manual*.)
- **Default CBE Zone Selection** This is the first zone in the 5 zone CBE list. Defaults are Zone 001 (Heat detectors) Zone 002 (Ion detectors) Zone 003 (Photo detectors) Zone 004 (Laser detectors) Zone 005 (Multisensor). Values may differ depending on point programming.
- **Current alarm reading (xxx%)** The current alarm reading of the detector, as a percentage of the alarm sensitivity setting.
- **Alarm sensitivity level (Ax)** The alarm sensitivity (x=1-9) entered in the Detector Sensitivity Screen.
- **Pre-Alarm sensitivity level** The Pre-Alarm Sensitivity (1-9; 0 = Pre-Alarm not used) entered in the Detector Settings Screen.



**NOTE:** Refer to “Detector Sensitivity Settings” in the *NFS2-640 Programming Manual* for more information on the Pre-Alarm and Alarm Sensitivity settings

- **Cooperative Multi-Detector selection** A smoke detector programmed to evaluate readings from nearby detectors in making Alarm or Pre-Alarm decisions. Cooperative Multi-Detector sensing also allows the combination of ionization with photoelectric technology in reaching an alarm decision.
  - \* – Multi-not used.
  - A** – combines the detector’s alarm decision with the next SLC address above.
  - B** – combines the detector’s alarm decision with the next SLC address below.
  - C** – combines the detector’s alarm decision with the next SLC address above and the next SLC address below.
- **Alarm Verification (\* or V)**
  - \* – Alarm Verification not programmed for this detector.
  - V** – Alarm Verification enabled.

Alarm Verification is a user-defined global time function that can reduce the number of nuisance alarms. Refer to page page 36 for more information.
- **Device SLC Address** The SLC address of the detector.

### How to View Read Status for a Control/Relay or Monitor Module

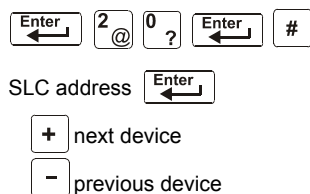

From the “Read Status” screen, press **0**, then press the ENTER key. You can now view Read Status for a monitor or a control/relay module as follows: press MODULE, enter the SLC address, then press the ENTER key. For example, to read the status of a FCM-1 module 2M147: press MODULE, enter 2 then 147, then press the ENTER key. The control panel now displays information about the module as shown in Figure 4.2.

The display and descriptions of the fields are shown below:

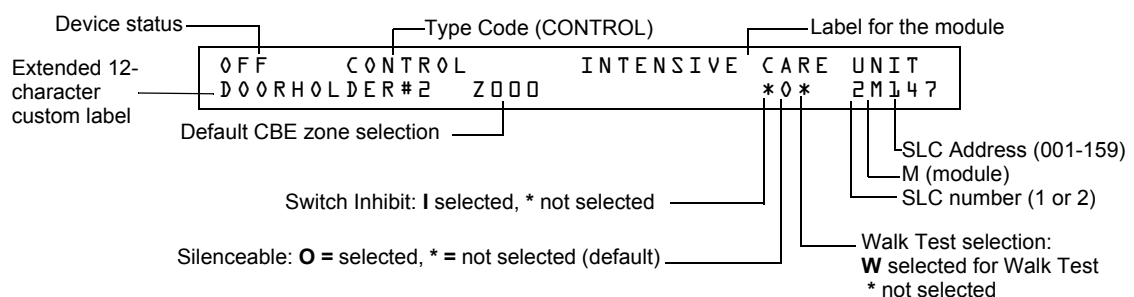

**Figure 4.2 Sample Control/Relay or Monitor Module Read Status Display**

- **Device Status** The status of the module: control/relay module [On (device active) OFF (device not active)] or monitor module (Normal, Alarm, or Test).
- **Type Code** The software Type Code that identifies the type of module. (Refer to “Point Programming” in the *NFS2-640 Programming Manual*.)
- **CBE list** Only the first zone in the device’s CBE list will be displayed.
- **Device SLC Address** The SLC address of the module.
- **Switch Inhibit (control/relay module only)** Displays whether the remote ON/OFF capability of the device is inhibited. (I=on; \*=off).
- **Silenceable (control/relay module only)** A selection that specifies if the device can be silenced during an alarm by pressing the signal silence key. Possible values are:  
 \* = output nonsilenceable  
 F = silenceable, resound by fire alarm  
 U = silenceable, resound by supervisory alarm  
 B = silenceable, resound by security alarm  
 T = silenceable, resound by trouble  
 O = silenceable, does not resound



**NOTE:** If the “Strobe” Type ID is used with System Sensor Strobe synchronization, F, U, B, T, or O will silence the entire circuit, “\*” will silence the horn portion only.

**Walk Test (control/relay module only)** A selection that specifies if the device will activate during a Walk Test.

### How to View Read Status for a NAC

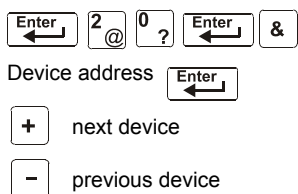

From the “Read Status” screen, press **0**, then press the ENTER key. You can now view Read Status for a NAC as follows: press OUTPUT, enter the device address, then press the ENTER key. For example, to read the status of NAC 0-2: press OUTPUT, enter 02, then press the ENTER key. The control panel now displays information for a NAC as shown in Figure 4.3.

The display and descriptions of the fields are shown below:

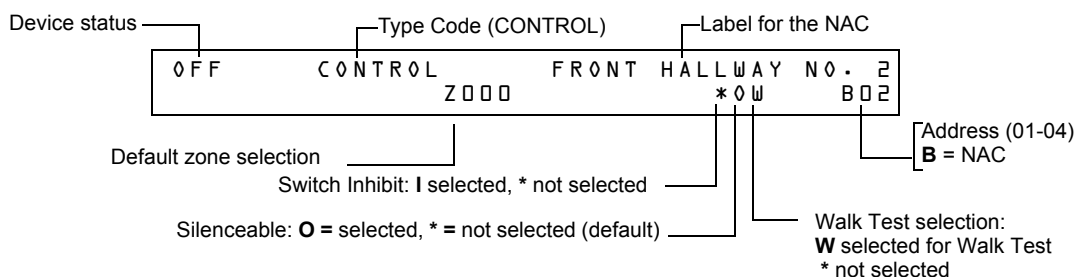

**Figure 4.3 Sample NAC Read Status Display**

- **Device Status** The status of the device: ON (device active) OFF (device not active).
- **Type Code** The software Type Code that identifies the type of NAC. Refer to “Appendix F - Type Codes” in *NFS2-640 Programming Manual*.
- **CBE List** Only the first zone in the NAC’s CBE list will be displayed here.
- **Device Address** The address of the NAC (01-04)
- **Switch Inhibit** A selection for disabling the switch function for the control/relay or transponder output circuit. (I=on; \*=off).

- Silenceable** A selection that specifies if the device can be silenced during an alarm by pressing the SIGNAL SILENCE key. Possible values are:
  - \* = output nonsilenceable
  - F = silenceable, resound by fire alarm
  - U = silenceable, resound by supervisory alarm
  - B = silenceable, resound by security alarm
  - T = silenceable, resound by trouble
  - O = silenceable, does not resound



**NOTE:** If the “Strobe” Type ID is used with System Sensor Strobe synchronization, F,U, B, T, or O will silence the entire circuit, “\*” will silence the horn portion only.

- Walk Test** A selection that specifies if the device will activate during a Walk Test.

### How to View Read Status for a Software Zone (Z01-Z99)

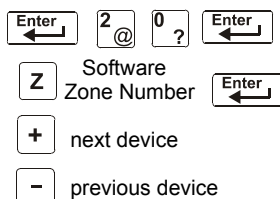

From the “Read Status” screen, press 0, then press the ENTER key. You can now view Read Status for a Software Zone as follows: press Z, enter the zone number (01-99), then press the ENTER key. For example, to read the status of Software Zone 07: press Z, enter 07, then press the ENTER key. The control panel now displays information for a Software Zone as shown below.

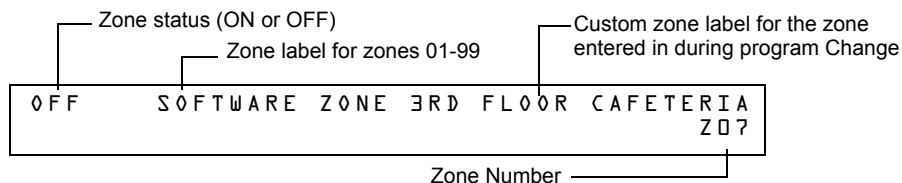

**Figure 4.4 Sample Software Zone Read Status Display**

### How to View Read Status for a Special Zone (F0-F9, FA-FC)

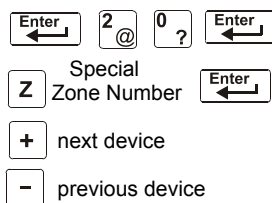

From the “Read Status” screen, press 0, then press the ENTER key. You can now view Read Status for a Special Zone as follows: press Z, enter the zone number (F0-F9, FA-FC), then press the ENTER key. For example, to read the status of Special Zone F8: press Z, enter F8, then press the ENTER key. The control panel now displays information for a Special Zone as shown below.



**NOTE:** The zone label depends on the type of Special Zone. For example, CODING FUNCTION CODE TYPE for F8.

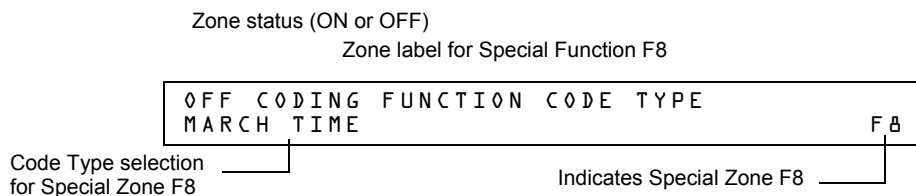

**NOTE:** Special Function Zones FA, FB, and FC are represented in VeriFire Tools as ZF10, ZF16, and ZF18, respectively.

**Figure 4.5 Sample Special Zone Read Status Display**

**How to View Read Status for a Releasing Zone (R0-R9)**

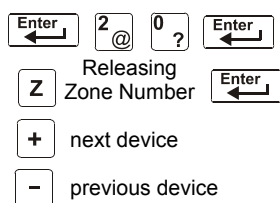

From the “Read Status” screen, press **0**, then press the ENTER key. You can now view the Read Status of a Releasing Zone as follows: press **Z**, enter the zone number (R0-R9), then press the ENTER key. For example, to read the status of Releasing Zone R0, enter **Z**, enter R0, then press the ENTER key. The control panel now displays information for a Releasing Zone as shown below.

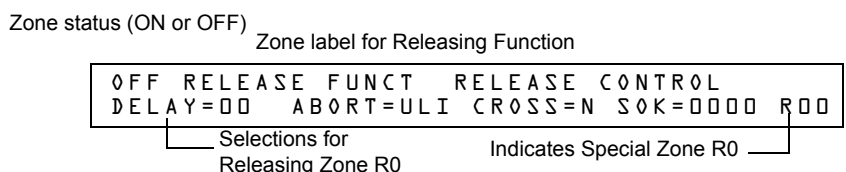

**Figure 4.6 Sample Releasing Zone Read Status Display**

**How to Read Status for System Functions**

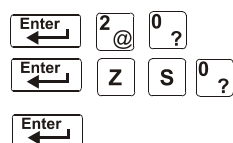

The “System Functions” screen specifies global settings for the control panel. From the “Read Status” screen, press **0**, then press the ENTER key. You can now view Read Status for System Functions as follows: press **Z**, enter **S0**, press the ENTER key. Shown below is a sample display and description of items for the Read Status of System Functions:



Parameter	Description	Settings
SIL INH=000	Silence Inhibit timer in seconds. Required in Canada and some areas of the USA.	000 = no timer; or the timer duration in seconds up to 300.
AUTO=000	Auto Silence Timer in seconds.	000 = no timer; 600-900 seconds.
VERIFY=30	Alarm Verification Timer	00 = no timer; 00-30 seconds.
USA TIME	Time and date display format	USA TIME or EUR TIME
TERM=N	Terminal supervision	YES – To supervise the wiring of an FDU-80. NO – No FDU-80 supervision.
AC_DLY=N	Delays AC loss reporting	YES - AC loss reporting is delayed for approximately 3 hours. NO - No AC loss delay.

**Table 4.1 System Function Parameters (1 of 2)**

Parameter	Description	Settings
LocT	One of three operating modes of a PC or terminal connected to the control panel (through TB12 PC Terminal)	LocT – terminal connected to control panel and located in the same room as the control panel. LocM – terminal connected to control panel but requires password for operation. RemT – terminal connected through a modem for Read Status operations only.
BLINK=01	The rate at which intelligent control or monitor modules blink during polling	BLINK=00: No blink BLINK=01: Devices blink on every poll. BLINK=16: Devices blink every 16th poll.
ST=4	NFPA wiring style operation for the SLC	4 – Style 4 SLC or 6 – both Style 6 and Style 7 SLC
ACS=N	Use ACS Selection Groups	N – No annunciator selected or Y – Select and display ACS Selection Groups

Table 4.1 System Function Parameters (2 of 2)

### How to Read Status for Annunciator Selections

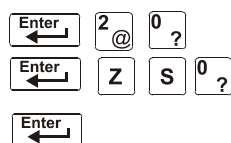

Annunciator Selection screens specify the information that displays on ACS annunciators. From the “Read Status” screen, press **0**, then press the ENTER key. You can now view Read Status for System Functions as follows: press **Z**, enter **S**, enter annunciation selection number (1-4 for annunciator, 5-8 for other settings), press the ENTER key. Sample LCD displays for the Read Status of Annunciator Selection are shown below:

A1=Address \_\_\_\_\_ ACS selection group

S1

```

ANNUN SELECTION1:  A1=H  A2=*  A3=*  A4=*
A5=*  A6=*  A7=*  A8=*  A9=*  A10=*  A11=*

```

Figure 4.7 Annunciator Selection 1 Screen

To view the next three annunciator selection screens, press the **+** (NEXT SELECTION) key.

S2

```

ANNUN SELECTION2:  A12=*  A13=*  A14=*
A15=*  A16=*  A17=*  A18=*  UDACT=N

```

Figure 4.8 Annunciator Selection 2 Screen

If UDACT=N, the control panel displays the Annunciator Selections 3 and 4 screen, addresses A20-A32, as shown below:

S3

```

ANNUN SELECTION3:  A20=*  A21=*  A22=*
A23=*  A24=*  A25=*  A26=*  A27=*  A28=*

```

S4

```

ANNUN SELECTION4:  A29=*  A30=*  A31=*
A32=*

```

Figure 4.9 Annunciator Selections 3 and 4 Screens

See page 42 and 43 of the NFS2 640 Programming Manual.

S5

REGION=0	TBL.REMIND=2	ALA.SCROLL=Y
LOCAL CONTROL=1	IP ACCESS=0	DCC-MODE=N

**Figure 4.10 System Function Selection 5 Screen**

See page 44 of the NFS2 640 Programming Manual.

S6

FLASHSCAN	L1DET	L1MOD	L2DET	L2MOD
	Y	Y	Y	Y

**Figure 4.11 System Function Selection 6 Screen**

See Page 42 of the NFS2 640 Programming Manual.

S7

NODE: 000.XXX, STYLE?:N
THRESHOLD CHANNEL A:H, CHANNEL B:H

**Figure 4.12 System Function Selection 7 Screen**

- SEC\_RLY and SUP\_RLY (0= turn on by Fire Alarm, 1= turn on by Security, 2= turn on by Supervisory).
- BAT\_SIZE (1= battery size is greater than 26 Ahr, 0= less than 26 Ahr).
- C\_DRILL (custom drill N= No custom drill, Y= Yes).
- TERM\_DATA (0= LCD80 Terminal using 7 bit data, 1= LCD80 Terminal using 8 bit data).
- PRT\_BAND (0= 2400, 1= 4800, 2= 9600).

S8

SEC_RLY:1	SUP_RLY:2	BAT_SIZE:0	C_DRILL:N
TERM_DATA:0	PRT_BAUD:2	CHARGER:Y	

**Figure 4.13 System Function Selection 8 Screen**

---

**NOTE:** Please refer to the VeriFire Tools help file for information on programming the above screen.

---

An Annunciator Selection screen shows the information that will display on the ACS annunciators.

1 through 9	Programmable Annunciator #1 through #9
0	Programmable Annunciator #10
A	8 Systems points + Zones 1-56
B	Zones 57-99, 9 F zones, 8 R zones, 4NAC
C	Loop 1, Modules 1-64
D	Loop 2, Modules 1-64
E	Loop 1, Modules 65-128
F	Loop 2, Modules 65-128
G	Loop 1, Modules 129-159 & Loop 2, Modules 129-159
H	Loop 1, Detectors 1-64
I	Loop 2, Detectors 1-64
J	Loop 1, Detectors 65-128
K	Loop 2, Detectors 65-128
L	Loop 1, Detectors 129-159 & Loop 2, Detectors 129-159
M	Programmable for use with FireVoice NFV-25/50ZS
N	8 Systems points + Zones 1-56, used for remote station communicator (TM-4)
O	8 Systems points + Zones 1-56, used for municipal box trip output (TM-4)
P	Loop 1, Modules 65-100, Loop 1, Detectors 1-14 (Detector Maintenance Reporting)
Q	Loop 2, modules 65-100, Loop 2, Detectors 1-14 (Detector Maintenance Reporting)
R	Loop 1, detectors 15-46 (Detector Maintenance Reporting)
S	Loop 2, Detectors 15-46 (Detector Maintenance Reporting)
T	Loop 1 Detectors 47-78 (Detector Maintenance Reporting)
U	Loop 2, Detectors 47-78 (Detector Maintenance Reporting)
V	Loop 1, Detectors 79-100 (Detector Maintenance Reporting)
W	Loop 2, Detectors 79-100 (Detector Maintenance Reporting)

Annunciator addresses 1 to 19 can be programmed to any one of the above selections. If there is a UDACT or UDACT-2, selections A-M will be sent to Annunciator addresses 20 to 32 respectively.

**Table 4.2 ACS Selection Groups (2 of 2)**

The table above contains the ACS display selections. Annunciators set to annunciator address 1 to 19 can be programmed to any one of the above selections. If there is a UDACT or UDACT-2, selections A-M will be sent to Annunciator addresses 20 to 32 respectively.

An example of ACS selections in Annunciator Selection Screen 1:

ANNUN SELECTION:	A1=H	A2=C	A3=*	A4=* A5=* A6=* A7=* A8=* A9=* A10=* A11=*
------------------	------	------	------	--

**Figure 4.14 Annunciator Selection Screen 1 Example**

**NOTE:** An ACS selection marked with an asterisk (\*) indicates no annunciator selection.

The figure above shows annunciator selections for addresses A1-A2 (addresses A3-A10, marked with asterisks, are not selected).

- Annunciators set to annunciator address 1 (A1) display the status of detectors 1-64 on SLC 1 (ACS Selection Group H)
- Annunciators set to annunciator address 2 (A2) display the status of intelligent modules 1-64 on SLC-1 (ACS Selection Group C).

### How to Read Status for Battery Levels

Pressing the BATTERY LEVEL key on the NFS2-640 keyboard displays information concerning the state of the battery.

A sample LCD display is shown below.

Battery Voltage: 27.48V
Charger Current: 00.06A

**Figure 4.15 Battery Levels**



## 4.4.2 How to View Read Status for Event and Alarm History

### Overview

The control panel maintains a History buffer of the last 800 events, each with a time and date stamp. History events include the following:

- All alarms, troubles and operator actions, such as: Acknowledge, System Reset, Signal Silence, Drill, and Walk Test.
- Programming entries (Program Change and Status Change, but not Read Status), along with a number (0-9) indicating the programming submenu (for example, 0=Clear). For an example, see Figure 4.18.

You can view events from the History buffer in two forms: by displaying all events (option 2, HIST=2) or by displaying alarm events only (option 4, ALARM HIST=4).



**NOTE:** The History buffer contains 800 events total, including the alarm events that display for Alarm history. The control panel generates Alarm history from the alarm events that exist in the 800-event History buffer.

### How to View Read Status for Event History



Option 2 (HIST=2) lets you view the total number of events in the History buffer (up to 800 events), then view each event in chronological sequence. From the “Read Status” screen, press 2, then press the ENTER key to display the “Event History” screen. A sample of the Event History screen is shown below:

```
EVENT HISTORY START
EVENTS IN HISTORY: 550
```

The number of events in the History buffer

**Figure 4.16 Sample Event History Display**

To display events in the History buffer, do the following:

- Press the NEXT SELECTION key to step through each event from the first entry (oldest event first) in the History buffer, or
- Press the PREVIOUS SELECTION key to step through each event from the most recent entry in the History buffer.



**NOTE:** The NEXT SELECTION key will show the most recent event first, and then move to its normal function of displaying the oldest events first.

A sample LCD display for a trouble event:

```

Type of event -----
TROUBL IN SYSTEM      GROUND FAULT
                       01:46P 041508 Tue
-----
Time and date of the event -----
```

**Figure 4.17 Sample Trouble Event Display**

A sample LCD display for a Program Change event:

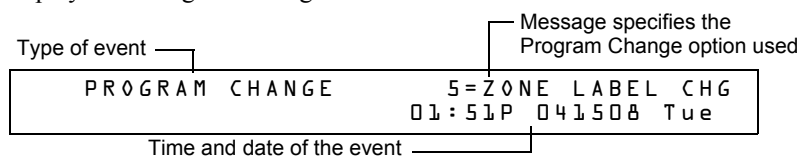

**Figure 4.18 Sample Program Change Event Display**

## How to View Read Status for Alarm History



next event



previous event

Option 4 (ALARM HIST=4) lets you view the total number of alarms in the History buffer (up to 200), then view each alarm in chronological sequence. From the “Read Status” screen, press **4**, then press the ENTER key to display the “Event History” screen. A sample Alarm History screen is shown below:

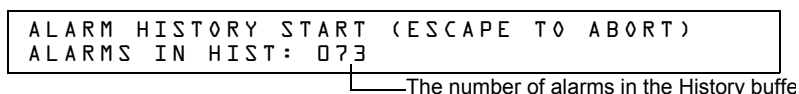

**Figure 4.19 Sample Alarm History Display**

To display alarms in the buffer, do the following:

- Press the NEXT SELECTION key to step through each alarm from the first entry (oldest alarm first) in the buffer, or
- Press the PREVIOUS SELECTION key to step through each alarm from the most recent entry in the buffer



**NOTE:** The NEXT SELECTION key will show the most recent event first, and then move to its normal function of displaying the oldest events first.

A sample display for an alarm event:

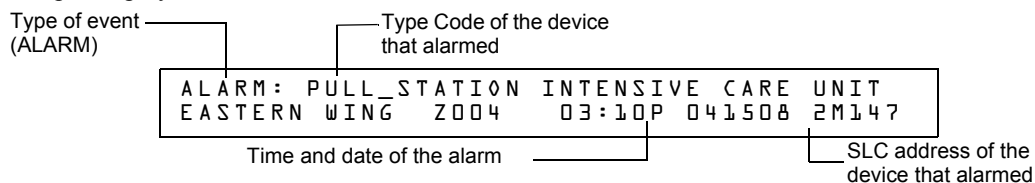

**Figure 4.20 Sample Alarm Event Display**

## 4.4.3 How to Print Points, Event and Alarm History

### Overview

Read Point options 1, 3, and 5 in the “Read Status” screen let you print points, event history, and alarm history. This section contains instructions for printing, as well as sample point, event history, and alarm history printouts.



**NOTE:** Before printing, make sure your control panel is connected to a compatible printer and the printer is configured according to the manufacturer’s specifications, and that the correct baud rate is selected at the panel.

## How to Print Points

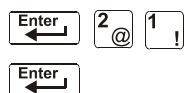

Option 1 (PRNT POINT=1) lets you print a list of all points programmed into the system. From the “Read Status” screen, press **1**, then press the ENTER key to print a list of installed points. A sample Print Point screen is shown below:

```
STATUS PRINT
```

**Figure 4.21 Sample Print Point Display**

A sample printout of three points using the Print Point option:

```
NORMAL SMOKE (PHOTO) DETECTOR ADDR 1D043      Z003 000%A8 8 ** 1D043
NORMAL SMOKE (PHOTO) DETECTOR ADDR 1D044      Z003 000%A8 8 ** 1D044
NORMAL SMOKE (PHOTO) DETECTOR ADDR 1D045      Z003 000%A8 8 ** 1D045
```

## How to Print Event History

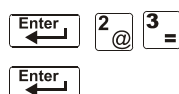

Option 3 (HIST=3) lets you print a list of all events in the History buffer (up to 800). From the “Read Status” screen, press **3**, then press the ENTER key to print a list of events. A sample History Print screen is shown below:

```
HISTORY PRINT
```

**Figure 4.22 Sample History Print Screen**

A sample printout of three events in history using the History Print option:

```
***** EVENT HISTORY START*****
SYSTEM RESET                                02:28P 042408 Thu
ALARM: SMOKE (ION) DETECTOR ADDR 1D075      Z002 02:28P 042408 1D075
ALARM: SMOKE (ION) DETECTOR ADDR 1D076      Z002 02:28P 042408 1D076
ACKNOWLEDGE                                02:28P 042408 Thu
```

## How to Print Alarm History

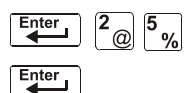

Option 5 (ALARM HIST=5) lets you print a list of alarm events in the History buffer (up to 200). From the “Read Status” screen, press **5**, then press the ENTER key to print a list of alarm events. A sample Print Alarm History screen is shown below:

```
ALARM HISTORY PRINT
```

**Figure 4.23 Sample Print Alarm History Display**

A sample printout of two alarm events in the History buffer using the Print Alarm History option.

```
*****ALARM HISTORY START*****
ALARM: SMOKE (ION) DETECTOR ADDR 1D075      Z002 02:28P 012208 1D075
ALARM: SMOKE (ION) DETECTOR ADDR 1D076      Z002 02:28P 012208 1D076
*****
PRINT END *****
```

### 4.4.4 How to View and Print Hidden Event and Alarm History

The control panel maintains a copy of the History buffer. For instance, if someone clears the History buffer using Status Change programming option 4, the control panel retains a copy of the History buffer. The copy of the preceding History buffer is called a Hidden History buffer and a copy of the preceding Alarm History is called a Hidden Alarm History buffer.

If you attempt to view or print history and the control panel displays one of the screens shown below you can use the options listed in the table below to view the contents of a Hidden History buffer.



**Figure 4.24 History Empty Display**



**Figure 4.25 Alarm History Empty Display**

Options for viewing and printing Hidden History and Hidden Alarm History do not appear in the LCD display when in Read Status. You can view and print the contents of these Hidden History buffers using the options listed in the table below. You read and print Hidden History and Hidden Alarm History the same way you read and print history using the options that appear on the “Read Status” screen. The table also contains references to the sections that contain instructions for reading and printing history.

To	Press	Refer to
Read Hidden Alarm History	2 @ 6 :	“How to View Read Status for Alarm History” on page 50
Print Hidden Alarm History	2 @ 7 \	“How to Print Alarm History” on page 51
Read Hidden History	2 @ 8 .	“How to View Read Status for Event History” on page 49
Print Hidden History	2 @ 9	“How to Print Event History” on page 51

**Table 4.3 Hidden History Selections**

# Appendix A: Special Zone Operation

## A.1 Overview

This section contains information for operating the control panel as detailed in the topics listed below:

Section	Special Zone	Refer to Page
A.2, "Releasing Zones (R0-R9)"	R0-R9	page 53
A.3, "Time, Date, and Holiday Functions"	F5, F6, F7	page 56
A.4, "NAC Coding"	F8	page 58
A.5, "Presignal and Positive Alarm Sequence (PAS) Operation"	F0	page 59

## A.2 Releasing Zones (R0-R9)

### A.2.1 Purpose of Releasing Zones



**WARNING: WHEN USED FOR CO<sub>2</sub> RELEASING APPLICATIONS, OBSERVE PROPER PRECAUTIONS AS STATED IN NFPA 12. DO NOT ENTER THE PROTECTED SPACE UNLESS PHYSICAL LOCKOUT AND OTHER SAFETY PROCEDURES ARE FULLY COMPLETED. DO NOT USE SOFTWARE DISABLE FUNCTIONS IN THE PANEL AS LOCKOUT.**

The control panel provides ten Releasing Zones (R0-R9). These are special zones that you can use for up to ten independent releasing operations. This section contains descriptions of each Releasing Function option and an example of how Releasing Zone options work.

For instructions on programming Releasing Functions, refer to the *NFS2-640 Programming Manual*.

Each Releasing Zone includes the following releasing options:

Option	Description
Cross Zone	Cross Zones let you program the control panel to activate a Releasing Zone when two or more detectors or modules are alarmed. Cross Zone selections are: <b>Y</b> Two or more detectors are alarmed that are mapped to one of the ten Releasing Zones (R0-R9) <b>Z</b> Two or more detectors are alarmed that are mapped to two different Software Zones and mapped to one of the ten Releasing Zones (R0-R9). <b>H</b> At least one smoke detector mapped to one of the ten Releasing Zones (R0-R9) is alarmed <i>and</i> at least one heat detector mapped to the same Releasing Zone as the smoke detector is alarmed. <b>N</b> Cross Zones not used
Delay Timer	Select a 0–60 second delay before activating a zone.
Abort	An Abort Switch Type Code used to abort activation of a zone.
Manual Release	Allows immediate zone activation by overriding the abort function, cross-zone function, and delay timer.
Soak Timer	Automatically shuts off the releasing device after a preprogrammed period of time. Select 0001-9999 seconds for a Soak Timer or 0000 seconds for no Soak Timer.

**Table A.1 Releasing Options**

## A.2.2 How to View Releasing Zone Selections

You can use the Read Status Entry option to view the current selections for a Releasing Zone. For example, to view selections for Releasing Zone R1, press the keys in sequence:

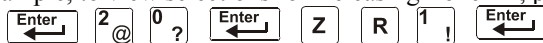

A sample LCD display of a Releasing Function selected for Releasing Zone R1:

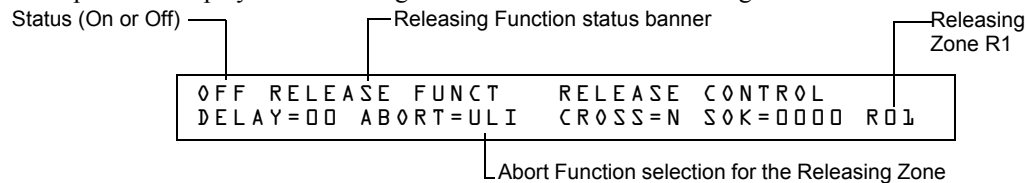
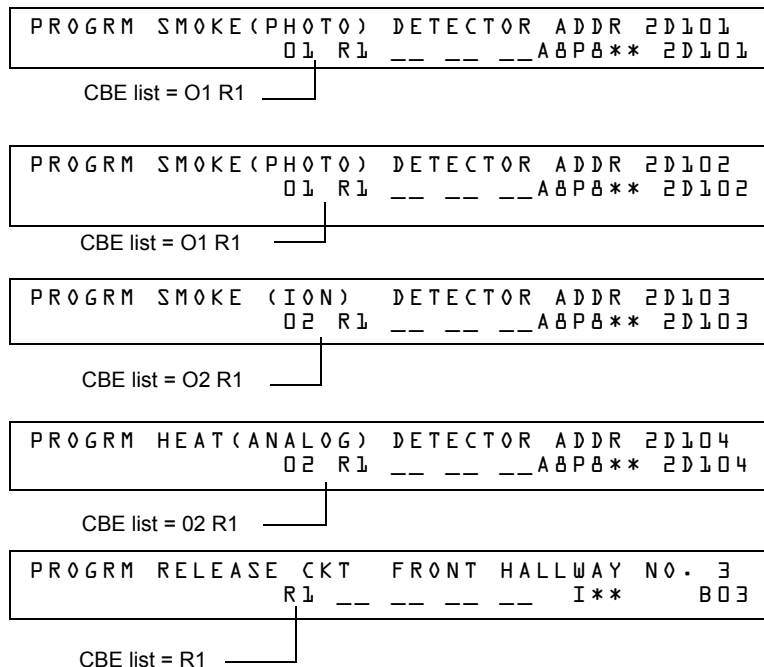
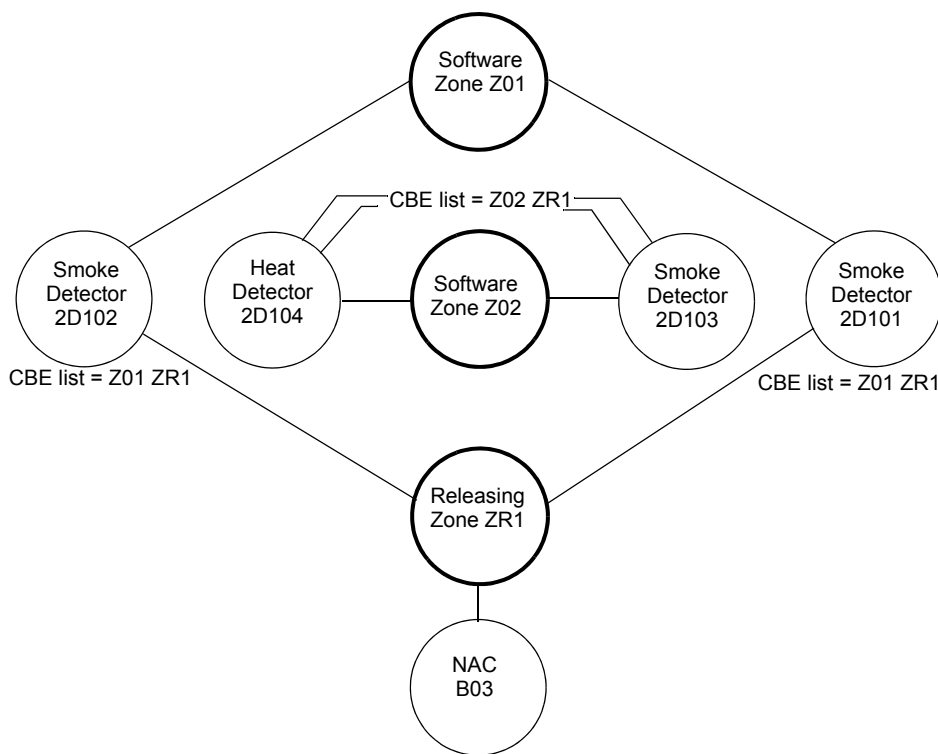

Figure A.1 Sample Read Status for a Releasing Zone

## A.2.3 How Releasing Zones Operate

The figure below contains an illustrated example of how Releasing Zones work, using cross zone selections with four detectors and a NAC mapped to Releasing Zone 1 (listed as ZR1 in the CBE list). Table A.2 lists the cross zone selections and the conditions that activate the Releasing Zone:





**Figure A.2 Illustrated Example of Cross Zone Programming**

Listing of each Cross Zone option and the conditions required to activate the Releasing Zone, according to the example shown in Figure A.2.

Cross Zone Selection (Cross=)	Condition(s) Required to Activate the Releasing zone
Cross=N	An alarm from any detector or module activates the releasing circuit.
Cross=Y	An alarm from any two detectors or modules activates the releasing circuit.
Cross=Z	An alarm from two detectors or modules mapped to different Software Zones, but mapped to the same Releasing Zone. <ul style="list-style-type: none"> <li>• An alarm from 2D101 and 2D103 – detectors mapped to different zones, but both list ZR1 in their CBE.</li> <li>• An alarm from 2D102 and 2D104 – detectors mapped to different zones, but both list ZR1 in their CBE.</li> <li>• An alarm from 2D101 and 2D104 – detectors mapped to different zones, but both list ZR1 in their CBE.</li> <li>• An alarm from 2D102 and 2D103 – detectors mapped to different zones, but both list ZR1 in their CBE.</li> </ul>
Cross=H	Activation of heat detector 2D104 and one smoke detector (2D101, 2D102, or 2D103).

**Table A.2 Example of Cross Zone Selections**

## A.3 Time, Date, and Holiday Functions

### A.3.1 Overview

The control panel includes a real-time clock that displays the time-of-day, the date, and the day-of-week. The clock includes a lithium battery backup. Time displays in a USA format (12-hour time format with month/day/year) or a EUR (European) format as shown below:

```

TROUBL CONTROL          MODULE ADDR 1M159
                OPEN      03:48P 041508 1M159
  
```

USA Time and Date format (default)

```

TROUBL CONTROL          MODULE ADDR 1M159
                OPEN      15:48 140408 1M159
  
```

EUR Time and date format

**Figure A.3 Sample USA and EUR Time/Date Formats**

The control panel also provides Time Control zones F5 and F6 for time and date control functions and zone F7 for holiday functions.

### A.3.2 How to View Time Control Selections

You can use the Read Status Entry option to view the current selection for the Time function. To do so, press the following keys in sequence:

2 @ 0 ?  Z F 5 %

or

2 @ 0 ?  Z F 6 :



**NOTE:** For instructions on programming the Time function, refer to the *NFS2-640 Programming Manual*.

The LCD display shows the current selections for the Time Control function. The figure below shows a sample LCD display of a Time Control function:

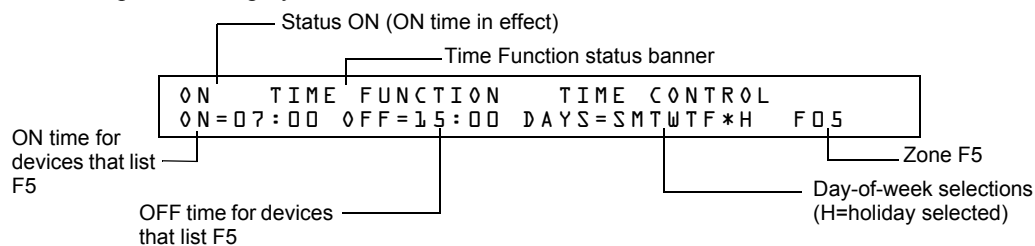

**Figure A.4 Sample Read Status for Time Function**



### A.3.3 How to View Holiday Function Selections

You can use the Read Status Entry option to view the current selection for the Holiday function. To do so, press the following keys in sequence:



**NOTE:** For instructions on programming the Holiday function, refer to the *NFS2-640 Programming Manual*.

The LCD display in Figure A.5 gives an example of an LCD display of a Holiday function:

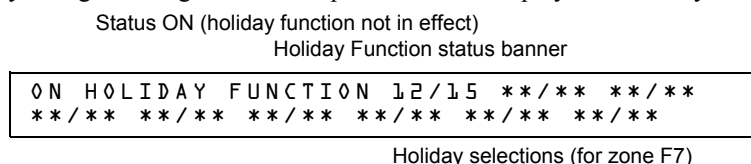

**Figure A.5 Sample Read Status for Holiday Function**

### A.3.4 How Time Control and Holiday Functions Work

Time and Holiday activation occurs automatically and does not require operator intervention. All outputs with a CBE list containing F5 or F6 activate within the times specified for the days of the week listed in F5 or F6. All smoke detectors with a CBE list containing F5 or F6 switch to their lowest sensitivity (AL:9) within the times specified for the days of the week listed in ZF5 or ZF6. Refer to “Intelligent Sensing Applications” in the *NFS2-640 Programming Manual* for details on setting detector sensitivity.

Time Control is active for all days of the week listed in F5 or F6. Holidays listed in F7 are excluded unless you list Holidays (H) in the day-of-week selection of F5 and F6 (shown in Figure A.4). Enter the time functions in a 24-hour format with the OFF time later than the ON time. After changing programming using Time Control, always reset the control panel.



**NOTE:** You can turn a NON FIRE control point on and off, by listing zone F5 or F6 in the CBE list of a control/relay module.

You can use Time Control zones F5 and F6 to program non-fire applications such as turning lights on and off, setting a thermostat, and so on. For example, you can program zones F5 and F6 to activate outputs at one time of day and deactivate outputs at later time, on specified days of a week. Table A.3 contains descriptions of additional Time Control applications:

Application	Requirement
Control day and night sensitivity of intelligent, addressable detectors	List zone F5 or F6 in the detector CBE. This automatically sets the detector sensitivity to the minimum setting (AL:9) during the day and automatically returns detector sensitivity to programmed sensitivity during the evening.
Control a specific date of year	Input up to nine date in the Holiday selection screen for Special Zone F7, then list zone F7 (Holiday) in the CBE of a device.

**Table A.3 Time Control Applications**

## A.4 NAC Coding

### A.4.1 Overview of Coding

A Coding selection is the Code Type that pulses when the control panel activates a NAC mapped to Special Zone F8. Special Zone F8 provides coding selections (see Table A.4) that you can list in the CBE of a NAC. To use a Code Type, program a NAC to list Zone F8 (reserved for a Code Type) in the NAC CBE list.



**NOTE:** Control modules (FCM-1, FRM-1) cannot be coded.

The table below contains descriptions of the signals that correspond to each NAC Code Type:

Coding Selection	Signal	Notes
March Time (default)	120 PPM (pulses Per minute)	Default selection for NACs mapped to F8.
Two-Stage	Alert signal (20 PPM) or General Alarm signal (Temporal pattern)	Alert signal – When an alarm occurs and not activated by another zone, the output pulses at 20 PPM. General Alarm signal – If not acknowledged within 5 minutes, the control panel switches from 20 PPM to Temporal pattern.
California	10 sec. On, 5 sec. Off, repeats	n/a
Temporal	0.5 on, 0.5 off, 0.5 on, 0.5 off, 0.5 on, 1.5 off, repeats	Used as a standard general EVAC signal.
Two-Stage Canada (3 minutes)	Alert signal (20 PPM) Drill Switch activation switches to Temporal pattern	Operates the same as Two-Stage except it will only switch to second stage: <ul style="list-style-type: none"> <li>• by activation of Drill Switch, or</li> <li>• the three minute timer expires, or</li> <li>• through a CBE event (General Alarm Z00 plus Zones 1-99 or Logic Zones 1-20)</li> </ul>
Two-Stage Canada (5 minutes)	Alert signal (20 PPM) Drill Switch activation switches to Temporal pattern	Operates the same as Two-Stage except it will only switch to second stage: <ul style="list-style-type: none"> <li>• by activation of Drill Switch, or</li> <li>• the five minute timer expires, or</li> <li>• through a CBE event (General Alarm Z00 plus Zones 1-99 or Logic Zones 1-20)</li> </ul>
Two-Stage Canada Manual	Alert signal (20 PPM) Drill Switch activation or CBE switches to Temporal pattern	Operates the same as Two-Stage except it will only switch to second stage: <ul style="list-style-type: none"> <li>• by activation of Drill Switch, or</li> <li>• through a CBE event (General Alarm Z00 plus Zones 1-99 or Logic Zones 1-20)</li> </ul>
System Sensor Strobe		Synchronizes System Sensor ADA horn/strobes.
Gentex Strobe		Synchronizes Gentex Horn/Strobes (Applies to NAC on CPU2-640 only)
Wheelock Strobe		Synchronizes Wheelock Horn/Strobes (Applies to NAC on CPU2-640 only)

**Table A.4 F8 Code Types and Audio Signals**

### A.4.2 How to View Coding (F8) Selections

You can use the Read Status Entry option to view the current selection for the Coding function. To do so, press the following keys in sequence:



**NOTE:** For instructions on programming the Coding function, refer to the *NFS2-640 Programming Manual*.

The LCD display shows the current selections for the Code Type. Figure A.6 shows a sample LCD display of a Code Type selection of March Time:

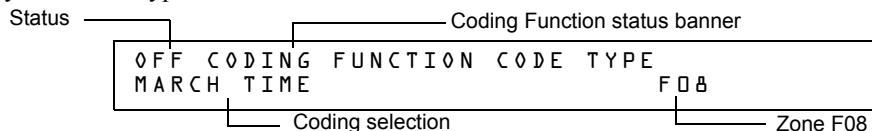

**Figure A.6 Sample Read Status for Coding Function**

### A.4.3 How to Respond to an Alarm with Coding

If an alarm occurs with a Coding selection, the control panel latches the control panel in alarm and pulses outputs mapped to F8 at the pulse specified by the Coding selection (see Table A.4). To silence the outputs, press the SIGNAL SILENCE key.

## A.5 Presignal and Positive Alarm Sequence (PAS) Operation

### A.5.1 Overview

This section describes the Presignal and PAS selection, and provides instructions on how to do the following:

- View Presignal and PAS selections
- Respond to an alarm with Presignal
- Operate the control panel with a Presignal Delay Timer only
- Operate the control panel with a Presignal Delay Timer and PAS

### A.5.2 What is Presignal and PAS?

Presignal is a feature that initially causes alarm signals to only sound in specific areas, monitored by qualified persons. This allows delay of the alarm from 60 to 180 seconds after the start of alarm processing. The control panel Presignal feature provides two selections:



**NOTE:** Presignal differs from the Alarm Verification Timer which does not require human intervention.

- A Presignal Delay Timer (60-180 seconds) that delays activation of all outputs with a CBE that includes Special Zone F0.
- A PAS selection, in addition to the Presignal Delay Timer, that allows a 15-second time period for acknowledging an alarm signal from a fire detection/initiating device. If the alarm is not acknowledged within 15 seconds, all local and remote outputs activate immediately and automatically.

An illustration of Presignal and PAS timing.

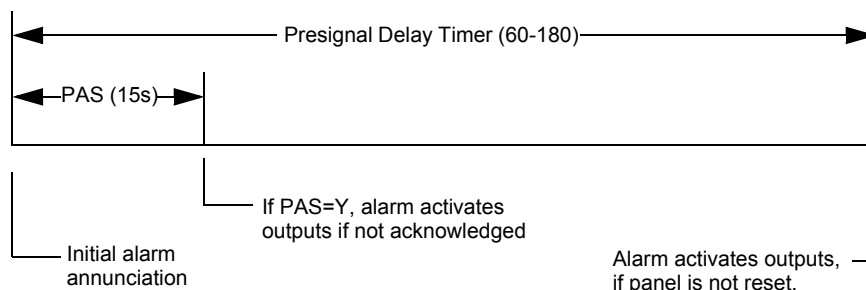
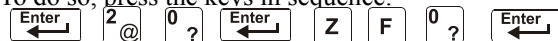

**Figure A.7 Presignal and PAS Time**

## A.5.3 How to View Presignal and PAS Selections

You can use the Read Status Entry option to view the current selection for the Presignal function.

To do so, press the keys in sequence:



**NOTE:** For instructions on programming the Presignal function, refer to the *NFS2-640 Programming Manual*.

The LCD display shows the current selections for the Presignal function. The figure below shows a sample LCD display of a Presignal function selected for PAS and a Presignal Delay Timer of 60 seconds:

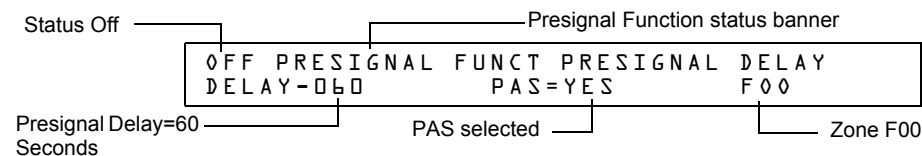

**Figure A.8 Sample Read Status for Presignal Function**



**NOTE:** If any monitor modules are programmed with a PAS INHIBIT Type Code and a fire alarm occurs, zone F0 goes false and aborts the Presignal Delay Timer.

## A.5.4 How to Respond to an Alarm with Presignal Delay Timer (no PAS)

If an alarm occurs with a Presignal Delay Timer (60-180 seconds), the control panel displays the type of device and the SLC address of the device causing the alarm. If a second alarm occurs during the Presignal Delay Timer, the control panel aborts the Presignal Delay Timer and activates all programmed outputs. A sample Alarm screen for a monitor module is shown below:

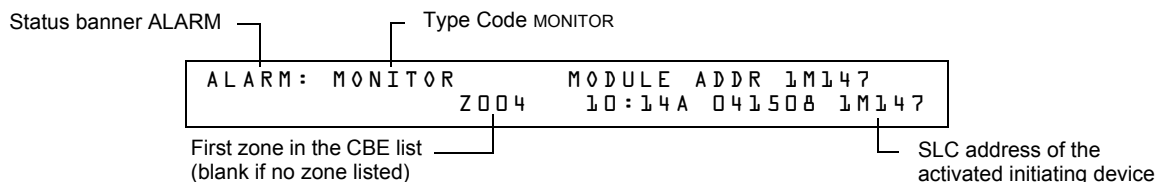

**Figure A.9 Sample Alarm Display Screen**

The FIRE ALARM LED flashes and the panel sounder pulses a steady tone. The control panel latches until the alarm is corrected and you press the SYSTEM RESET key to reset the control panel. You have the duration of the Presignal Delay Timer (60-180 seconds) to respond to the alarm before the control panel automatically activates all outputs programmed to F0. You can take the following actions:

- To silence the panel sounder and change the FIRE ALARM LED from flashing to steady, press the ACKNOWLEDGE/SCROLL DISPLAY key.
- To abort the Presignal Delay Timer, press the SYSTEM RESET key.
- To manually activate all outputs programmed to F0, press the DRILL key. The Manual Evacuate screen appears, the panel sounder pulses and the FIRE ALARM LED changes from flashing to steady. The Manual Evacuate screen and Alarm screen display alternately at 3-second intervals.

If the Presignal Delay Timer reaches its programmed value, without operator intervention, the control panel activates all outputs programmed to F0.

## A.5.5 How to Respond to an Alarm with Presignal Delay Timer (PAS selected)

If an alarm occurs with a Presignal Delay Timer (60-180 seconds) and PAS selected, the control panel displays an Alarm screen that shows the type of device and the SLC address of the device causing the alarm. When an alarm comes from an initiating device with a CBE list that includes F0 (with PAS selected), the control panel delays the following outputs:

- System Alarm relay
- TM-4 Polarity Reversal Alarm output
- TM-4 Municipal Box output



**NOTE:** These outputs do not delay for Presignal operations without PAS selected.

If a second alarm occurs during the Presignal Delay Timer, the control panel aborts the Presignal Delay Timer and activates all programmed outputs.

A sample Alarm screen for a monitor module:

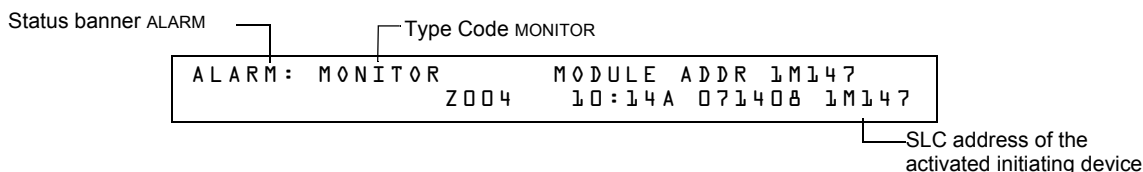

**Figure A.10 Sample Alarm Display Screen**

The FIRE ALARM LED flashes and the panel sounder pulses a steady tone. The control panel latches until the alarm is corrected and you press the SYSTEM RESET key to reset the control panel. You have 15 seconds to acknowledge the alarm or the control panel automatically activates all outputs programmed to F0. If you acknowledge the alarm within 15 seconds, the control panel increases the delay time to the full Presignal Delay Timer (60-180 seconds). You have the duration of the Presignal Delay Timer to respond to the alarm before the control panel activates all outputs programmed to F0. You can take the following actions:

- To increase the delay to the full programmed Presignal Delay Timer, press the ACKNOWLEDGE/SCROLL DISPLAY key. The panel sounder goes silent and the FIRE ALARM LED changes from flashing to steady.
- To abort the Presignal Delay Timer, press the SYSTEM RESET key.
- To manually activate all outputs programmed to F0, press the DRILL key. The Manual Evacuate screen appears, the panel sounder pulses and the FIRE ALARM LED changes from flashing to steady. The Manual Evacuate screen and Alarm screen display alternately at 3-second intervals.

If the Presignal Delay Timer reaches its programmed value, without operator intervention, the control panel activates all outputs programmed to F0.

# Appendix B: Intelligent Detector Functions



**NOTE:** For instructions on selecting Intelligent Detector Functions, refer to the *NFS2-640 Programming Manual*.

## Descriptions for Intelligent Detector Functions

Function	Description
Analog Display	The control panel reads and displays analog information from the 318 analog detectors (159 per SLC). The display shows the sensed air at the detector as a percentage of the alarm threshold for each detector.
Sensitivity Adjust	Nine selections for manually setting intelligent detector alarm levels within the UL range. <i>If using ionization detectors in duct applications, set Sensitivity Adjust to Level 1.</i> Refer to the <i>NFS2-640 Programming Manual</i> for detector sensitivity information.
Day/Night Sensitivity Operation	You can program the system to automatically force smoke detectors to minimum sensitivity during the day. Refer to "Time, Date, and Holiday Functions" on page 56.
Maintenance Alert	When compensation reaches the limit of the amount of drift compensation that can be safely applied, the control panel reports a trouble condition, according to National Fire Alarm Code standards. This condition also activates if the detector remains at very high or very low measured air levels for an extended time.
Automatic Test Operation	The control panel performs an automatic test of each detector every 320 minutes. Failure to meet the test limits causes an Auto Test Fail trouble.
Type Code Supervision	The control panel monitors hardware device Type Codes for each installed device at regular intervals (an interval can take up to 40 minutes for a full capacity system). If a mismatch of type compared to the program occurs, the control panel generates a point trouble labeled Invalid Type.
LED Control Operation	A global program selection to prevent detector LEDs from blinking as a result of polling during normal operation. A typical application is a sleeping area where a blinking light can distract people. As a standard function, independent of this programming selection, the control panel allows all LEDs to turn on in alarm.
Alarm Verification Timer and Verification Counter Operation	The control panel performs alarm verification on programmed intelligent smoke detectors. The Alarm Verification Timer is a global program selection of 0–60 seconds (ULC installations can not exceed 30 seconds). Each detector includes a Verification Counter, which displays the number of times that a detector entered verification but did not time-out to alarm. The Verification Counter increments to 99 and holds.

**Table B.1 Intelligent Detector Functions**

## Notes

# Appendix C: Remote Terminal Access

## C.1 General Description

The control panel can communicate with a remote terminal or computer connected to the EIA-232 PC/Terminal port. Refer to the *NFS2-640 Installation Manual* for installation information.



---

**NOTE:** See the *NFS2-640 Programming Manual* for instructions on enabling the CRT.

---

This port may be set up for interactive operation or for monitoring only. Interactive operation requires that all equipment be UL-listed under UL Standard for Safety UL 864 and be installed and set up as directed under Local Terminal Mode (LocT) or Local Monitor Mode (LocM).

ITE (Information Technology Equipment) equipment listed under UL 1950 is allowed for ancillary system monitoring when the system is installed and set up as directed under Remote Terminal Mode (RemT).

## C.2 Operating Modes

The control panel provides three operating modes for the CPU EIA-232 PC/Terminal port:

- Local Terminal - LocT
- Local Monitor - LocM
- Remote Monitor - RemM

You select the operating mode during control panel programming (Global System Functions). For more information, refer to the *NFS2-640 Programming Manual*.

The following subsections outline the functions, password requirements, and additional information for each operating mode.

### C.2.1 Local Terminal Mode (LocT)

Functions, passwords, and special requirements of Local Terminal Mode (LocT) are:

<b>Functions:</b>	Read Status, Alter Status, and Control Functions (Table C.1).
<b>Passwords:</b>	User-defined password for Alter Status functions.
<b>Requirements:</b>	The terminal must be mounted in a UL 864 listed enclosure or positioned to provide equivalent protection against unauthorized use.

Functions available with the Local Terminal Mode:

Function	Lets you...
Read Status	<ul style="list-style-type: none"><li>• Display the status of an individual point (Detector, Module, or Zone).</li><li>• Display a list of all the points in Alarm or trouble.</li><li>• Display a list of all programmed points in the system.</li><li>• Step through the History buffer event by event.</li><li>• Display the entire History buffer.</li><li>• Step through Alarm History</li><li>• Display the entire Alarm History</li></ul>
Alter Status	<ul style="list-style-type: none"><li>• Disable/Enable an individual point.</li><li>• Change the sensitivity of a detector.</li><li>• Clear the verification counter of all detectors.</li><li>• Clear the entire History buffer.</li><li>• Set the Intelligent Sensing alert and action levels.</li></ul>

**Table C.1 Local Terminal Mode Functions (1 of 2)**



Function	Lets you...
Control Functions	<ul style="list-style-type: none"> <li>• Acknowledge.</li> <li>• Signal Silence.</li> <li>• System Reset.</li> <li>• Drill.</li> </ul>

**Table C.1 Local Terminal Mode Functions (2 of 2)**

## C.2.2 Local Monitor Mode (LocM)

Functions, passwords, and special requirements of Local Monitor Mode (LocM) are:

- Functions:** Read Status, Alter Status, and Control Functions (Table C.2).
- Passwords:** User-defined password for Alter Status and Control functions.
- Requirements:** Password security feature for Control Functions eliminates the need for mounting the CRT-2 in an enclosure.

Functions available with the Local Monitor Mode:

Function	Lets you...
Read Status	<ul style="list-style-type: none"> <li>• Display the status of an individual point (Detector, Module, or Zone).</li> <li>• Display a list of all the points in Alarm or trouble.</li> <li>• Display a list of all programmed points in the system.</li> <li>• Step through the History buffer event by event.</li> <li>• Display the entire History buffer.</li> <li>• Step through Alarm History</li> <li>• Display the entire Alarm History</li> </ul>
Alter Status	<ul style="list-style-type: none"> <li>• Disable/Enable an individual point.</li> <li>• Change the sensitivity of a detector.</li> <li>• Clear the verification counter of all detectors.</li> <li>• Clear the entire History buffer.</li> <li>• Set the Intelligent Sensing alert and action levels.</li> </ul>
Control Functions	<ul style="list-style-type: none"> <li>• Acknowledge</li> <li>• Signal Silence</li> <li>• System Reset</li> <li>• Drill</li> </ul>

**Table C.2 Local Monitor Mode Functions**

## C.2.3 Remote Terminal Mode (RemT)

Functions, passwords, and special requirements of Remote Terminal Mode (RemT) are:

- Functions:** Read Status only. See Table C.3.
- Passwords:** None
- Requirements:** Use with UL ITE-listed terminals, including personal computers with the VeriFire™ Tools or terminal emulation software. Intended for terminals connected through modems, including FSK modems connected through a public switched telephone network.

Functions available with the Remote Terminal Mode:

Functions	Lets you...
Read Status	<ul style="list-style-type: none"> <li>• Display the status of an individual point (Detector, Module, or Zone).</li> <li>• Display a list of all the points in Alarm or trouble.</li> <li>• Display a list of all programmed points in the system.</li> <li>• Step through the History buffer event by event.</li> <li>• Display the entire History buffer.</li> <li>• Step through Alarm History</li> <li>• Display the entire Alarm History</li> </ul>
Alter Status	<ul style="list-style-type: none"> <li>• N/A</li> </ul>
Control Functions	<ul style="list-style-type: none"> <li>• N/A</li> </ul>

**Table C.3 Remote Terminal Mode Functions**

## C.3 Using the CRT-2 for Read Status

### C.3.1 Overview

This section shows how to perform Read Status functions from a CRT-2.



**NOTE:** See the *NFS2-640 Programming Manual* for instructions on enabling the CRT port.

For more information see the “Read Status” section of this manual.

Function	Lets you...
Read Point	Read the status of any point in the system (detectors, modules, software zones, and system parameters).
Alm/Tbl Status	Display a list of all devices in the system that are in Alarm or trouble.
Read All Points	Display a list of all points programmed in the system. This list will display the status of all addressable detectors, modules, system parameters and software zones.
History Step	Step through the History buffer one event at a time.
History All	Send the entire History buffer to the CRT, from the most recent event to the oldest event.
Alarm History Step	Step through Alarm History one alarm at a time.
Alarm History All	Display a history list of all alarms.

**Table C.4 Read Status Functions**

### C.3.2 Accessing Read Status Options

Access the Read Status function from the CRT-2 by following these steps.

1. Turn on the CRT-2, which is connected to the control panel.
2. Press the Read Status function key. The control panel displays the “Read Status” menu options:

```
Rd Point=1, Rd Alm/Tbl=2, All Points=3, Hist:Step=4/All=5, Ala-Hist:Step=6/All=7
```



The semicolon, a control character in networking applications, separates the hour and minute of events displayed from history. If events display as they occur, a colon separates the hour and minute.

Press <2> <ENTER>

TRUUBL SMOKE(PHOTO) DETECTOR ADDR 1D003	INVREP 01:09P 041608 1D003
TRUUBL SMOKE (ION) DETECTOR ADDR 1D004	INVREP 01:09P 041608 1D004
TRUUBL HEAT(FIXED) DETECTOR ADDR 1D006	INVREP 01:09P 041608 1D006
TRUUBL MONITOR MODULE ADDR 1M041	INVREP 01:09P 041608 1M041
TRUUBL IN SYSTEM GROUND FAULT	01:09P 041608 Wed
TRUUBL IN SYSTEM BATTERY	01:09P 041608 Wed

Semicolon

### C.3.5 Display All Programmed Points

From the “Read Status” menu, select option 3 - All Points. This option lets you view the status of all addressable detectors, modules, system parameters, and software zones.

NORMAL SMOKE(PHOTO) DETECTOR ADDR 1D002	Z003	000%A8 8 **	1D002
NORMAL SMOKE (ION) DETECTOR ADDR 1D003	Z002	020%A6 6 **	1D003
NORMAL HEAT(FIXED) DETECTOR ADDR 1D006	Z001	050% *	1D006
NORMAL SMOKE(LASER) DETECTOR ADDR 1D099	Z004	000%A6 6 *V00	1D099
OFF RELEASE CKT MODULE ADDR 1M001	ZR00	I**	1M001
NORMAL MONITOR MODULE ADDR 1M001	ZR00	I**	1M001
OFF RELAY MODULE ADDR 1M033	Z000	*FW	1M033
OFF SOFTWARE ZONE Zone 01			Z01

### C.3.6 Step-through History

From the “Read Status” menu, select option 4 - Step-through History. This option lets you step through all history events one at a time.

### C.3.7 View All History

From the “Read Status” menu, select option 5 - History ALL. The entire history of events will display on the screen.

### C.3.8 Step-through Alarm History

From the “Read Status” menu, select option 6 - Step-through Alarm History. This option lets you step through the panel’s alarm history one event at a time.

### C.3.9 View All Alarm History

From the “Read Status” menu, select option 7 - Alarm History All. The entire history of alarm events will display on the screen, from most recent to oldest.

Press <6> <ENTER>

***** EVENT HISTORY START *****			
ALARM: MAN_RELEASE MODULE ADDR 1M065	10:21A	041508	1M065
ALARM: MAN_RELEASE MODULE ADDR 1M065	10:19A	041508	1M065
ALARM: MAN_RELEASE MODULE ADDR 1M065	03:20P	041408	1M065
ALARM: SMOKE (ION) DETECTOR ADDR 1D129	03:20P	041408	1M065

Step through the Alarm History buffer one event at a time by pressing the Next **F5** or Prior **F6** function keys.

## C.4 Using the CRT-2 for Alter Status

### C.4.1 Overview

This section shows how to Alter Status functions from a CRT-2.



**NOTE:** The panel must be in Local Terminal Mode (LocT) or Local Monitor Mode (LocM).



**NOTE:** See the *NFS2-640 Programming Manual* for instructions on enabling the CRT port.

Function	Lets you...
Disable	Enable or disable detectors or modules.
Alarm/Pre-Alarm	Change the Alarm and Pre-Alarm levels of any addressable detector in the system.
Clear Verification	Clear the verification counter for all the addressable detectors in the system.
Clear History	Clear the contents of the History buffer.
Set Action/Alert	Set the Pre-Alarm for Alert or Action.

**Table C.5 Alter Status Functions**

### C.4.2 Accessing Alter Status Options

Access **Alter Status** function from the CRT-2 by following these steps.

1. Turn on the CRT-2 connected to the control panel.
2. Press the Alter Status function key. The control panel displays the Password screen.

Press <ALTER STATUS>

```
Enter Status CHange Password or Escape to Abort
```

3. Enter the Status Change Password. The factory default Status Change Password is 11111. The password does not display on the CRT-2. Five asterisks will appear in place of the password.

Press <1><1><1><1><1><ENTER>

```
*****
```

The Alter Status Options menu appears.

```
1=Disable 2=Alarm/Prealarm 3=Clear Verification 4=Clear History 5=Alert/Action
```

From the Alter Status Options menu, you can select **1-5**.

### C.4.3 Enable or Disable Detectors, Modules or Zones

From the “Alter Status” menu select option **1** - Disable. Disable lets you enable or disable detectors, modules, or zones.

```

Press <1><ENTER>
      |
      | SLC Number
      |
      | Address (01-159)
      |
  Disable/Enable. Type nD(nnn) / nMnnn / P(nn) / Z(nn) then Enter
  STATUS CHANGE      Dis/Ena point                               08:29A Tue 04/15/08
      |
      | Number
  
```

Enter the following:

1. Enter the SLC loop number **1** or **2**.
2. Enter the first letter to read one of the following, using upper case letters:
3. Detector = **D**  
Module = **M**  
NAC = **P**  
Zone - **Z**
4. Enter the address or number of the device.
5. Press ENTER and a display similar to the following will appear.

EXAMPLE Disable Detector address 101 on SLC1:

Press <1><D><1><0><1><ENTER>

```

D101 Now Enabled, Enter E(Enable) / D(Disable) or Esc. to Abort
  
```

Press **D** to Disable (**E** to Enable); then press ENTER.

Press <D><ENTER>

```

Device now disabled
TROUBL SMOKE(PHOTO) DETECTOR ADDR 101 Z03 DEVICE DISABLED 08:29A Tue 04/15/08 D101
  
```

### C.4.4 Change Alarm and Pre-Alarm Levels

This option lets you change the Alarm and Pre-alarm levels of any addressable detector in the system. Follow these steps.

1. From the “Alter Status” menu select option **2** - Alarm/Pre-alarm.

Press <2><ENTER>

```

Det. Alarm/Prealarm level, type address D(
TROUBL SMOKE(PHOTO) DETECTOR ADDR 101 Z03 DEVICE DISABLED 08:29A Tue 04/15/08 D101
  
```

2. Enter the address of the detector you wish to change. For example, change alarm and pre-alarm levels for detector 102 on SLC 1 to Alarm Level 4 & Pre-alarm Level 2.

Press <1><D><1><0><2><ENTER><A><5><P><2><ENTER>

```

STATUS CHANGE Alarm/Prealarm level                               08:29A Tue 04/15/08
D102 sens. at level 5, Prealarm at level 3, Enter AxPx to change, Esc. to Abort
D102 now set at new Alarm level 5 and new Pre-alarm level 2
  
```

### C.4.5 Clear Verification Counter

Clear verification lets you clear the verification counter for all the addressable detectors in the system.

Press <3><ENTER>

```
STATUS CHANGE   Clear verify count           08:29A Tue 04/15/08
```

### C.4.6 Clear the Entire History Buffer

Clear History lets you clear the entire History buffer.

Press <4><ENTER>

```
*****History Clear*****
```

### C.4.7 Set the Pre-Alarm for Alert or Action

Set Action/Alert lets you set the Pre-alarm for Alert or Action. For example, change Pre-alarm from “Alert” to “Action” as follows:

Press <5><ENTER>

```
Set Pre-alarm Alert (NO)/Action(YES). Type N or Y then Enter
STATUS CHANGE   Change Alert/Action           08:29A Tue 04/15/08
```

Press <Y><ENTER>

```
Pre-alarm now set for ACTION
```

# Appendix D: Point and System Troubles Lists

There are a variety of point or system trouble types that may appear in a trouble message. The tables below give lists of the troubles and indications of their cause.

## D.1 Point (Device) Troubles

A message from the “Trouble Type” column in the following table will appear in the upper right corner of the panel display when a point (device) trouble occurs. Use this table to help determine what the trouble is.

POINT TROUBLES		
TROUBLE TYPE	TROUBLE DESCRIPTION	ACTION
AC FAILURE	The auxiliary power supply has lost AC power.	Determine whether there is an AC power loss or whether the power supply and wiring is correct.
ADRFLT	.Detector and new sounder base address doesn't match. Or the ACPS address is incorrect.	Readdress the incorrect device.
ALIGN	A beam detector is in configuration mode.	No action is necessary, as the trouble will clear when the configuration is complete. However, the detector will not detect a fire while this trouble exists.
BLOCK	Something has come between the detector's beam and its reflector.	Investigate and clear the blockage.
CHGFLT*	The power supply's battery charger is not working properly.	Correct the fault.
CO 6MN	The CO (carbon monoxide) detection element on a detector has six months left to expiration. (This trouble generates in FlashScan mode only. CLIP mode will generate a LO VAL error, if applicable.)	Replace the detector.
CO EXP	The CO (carbon monoxide) detection element on a detector has reached the expiration date. (This trouble generates in FlashScan mode only. CLIP mode will generate a LO VAL error, if applicable.)	Replace the detector.
CO TBL	The CO element on a detector is not working properly. (This trouble generates in FlashScan mode only. CLIP mode will generate a LO VAL error, if applicable.)	Replace the detector.
DIRTY 1	The detector is dirty and needs cleaning	Clean the detector.
DIRTY 2	The detector requires cleaning immediately. It is a false alarm risk.	Clean the detector immediately.
DISABL	The point has been disabled.	Service and re-enable the point.
GNDFLT	There is a ground fault on the main or auxiliary power supply.	Correct the fault.
HI BAT	The auxiliary power supply's battery charge is too high.	Check the batteries for problems. Replace batteries if necessary.
INVREP	The device has returned a response to the panel that the panel did not expect.	Check the device for functionality, addressing and wiring.
IR TBL	The infrared element is not working properly on an FSC-851 IntelliQuad detector. (This trouble generates in FlashScan mode only. CLIP mode will generate a LO VAL error.)	Replace the detector.
LO BAT	The auxiliary power supply's battery charge is low.	Check the batteries for problems. Replace batteries if necessary.
LO TEMP	The temperature read by a Heat+ or Acclimate™+ detector is too low.	Raise the heat in the area of the detector.
LO VAL	The detector chamber reading is too low; the detector is not operating properly. Or (CLIP Mode only) the thermistors, CO element, or infra-red element on an FSC-851 IntelliQuad detector is not working properly, or the FSC-851 IntelliQuad is experiencing a freeze warning.	The detector must be removed and replaced by an authorized service representative.
NO ANS	The device (module or detector) is not responding to the poll. Either the device is not working or it is not connected properly.	Determine whether the device is functional, and connected and addressed properly on the SLC.
NO SIG	The device (module or detector) is not responding to the poll. Either the device is not working or it is not connected properly.	Determine whether the device is functional, and connected and addressed properly on the SLC.
OPEN	The module device has an open circuit on its supervised wiring.	Check the connections from the module to the input or output device to which it is wired.
OPEN ON <u>x</u>	There is an open on speaker circuit <u>x</u> .	Locate the open and fix.
PSFAIL	The power supply is not working properly.	Check the battery for problems. Replace battery if necessary.
PRLOSS	The output module or new sounder base lost power.	Turn power back on.
SHORT	The module device has a short circuit on its supervised wiring.	Check the connections from the module to the input or output device to which it is wired.
SHORT ON <u>x</u> .	There is a short on speaker circuit <u>x</u> .	Locate the short and fix.

**Table D.1 Point (Device) Troubles (1 of 2)**



POINT TROUBLES		
TROUBLE TYPE	TROUBLE DESCRIPTION	ACTION
TEST F	This detector has failed the FACP's periodic detector test for alarm capabilities.	The detector should be removed and replaced by an authorized service representative.
THERM	The thermistors are not functioning properly on an FSC-851 IntelliQuad detector. (This trouble generates in FlashScan mode only. CLIP mode will generate a LO VAL error.)	Replace the detector.
VER HI	This detector, which has been programmed to participate in alarm verification, has gone into and come out of verification its programmed limit without going into alarm. Either something is wrong with the detector or there is a condition nearby (such as someone smoking) that causes it to go into verification frequently.	Check the detector and the nearby conditions to determine the problem.
XP TBL	XPIQ general trouble.	Check the XPIQ point for problems.
* This trouble may be fire panel or backup battery related. Test and replace backup batteries if necessary.		

Table D.1 Point (Device) Troubles (2 of 2)

## D.2 System Troubles

A message from the “Trouble Type” column in the following table will appear in the panel display when a system trouble occurs. Use this table to help determine the cause of the trouble.

SYSTEM TROUBLES		
TROUBLE MESSAGE TYPE	TROUBLE DESCRIPTION	ACTION
AC FAIL	The main power supply has lost AC power.	Investigate whether there is an AC power loss, or whether the PS is correctly installed and wired.
ADV WALK TEST	There is an Advanced Walk Test in progress.	No action is required.
ANNUN $\underline{x}$ NO ANSWER	The annunciator at address $\underline{x}$ is not responding.	Determine whether the device is functional, and connected and addressed properly.
ANNUN $\underline{x}$ TROUBLE	The annunciator at address $\underline{x}$ is in trouble.	Determine if the ACS module is functional, correctly installed, and configured properly.
AUXILIARY TROUBLE	An auxiliary device connected to the CPU2-640 at J6 is in trouble or the cable is missing.	Check the wiring and source.
BASIC WALK TEST	A Basic Walk Test is in progress.	No action is required.
BATTERY	The main power supply's battery charge is too high or too low.	Check batteries, replace if necessary.
BAT.BACKUP RAM	RAM battery backup is low.	Replace battery.
CHARGER FAIL*	The main power supply's battery charger is not working properly.	Correct the fault.
CORRUPT LOGIC EQUAT	The database that houses the panel's logic equations is corrupt.	The database must be re-downloaded, or all programming must be cleared and re-entered.
DRILL ACTIVATED	Drill has been activated.	No action is required.
DVC ANALOG OUT $\underline{x}$ TBL	A trouble has occurred on DVC-AO analog output $\underline{x}$ (1-4). The analog output is configured for style 7, but no audio signal is returned.	Investigate and fix.
DVC AUDIO LIB. CORRUP	The audio library is corrupt.	The library must be re-downloaded, or all programming must be cleared and re-entered. If the trouble still does not clear, contact Technical Services.
DVC AUDIO LIB. INCOMP	The audio library is not compatible with the programming database.	Check the version using VeriFire Tools. Correct and re-download the database and audio library.
DVC BUZZER OFF-LINE	The piezo is disabled.	Re-enable the piezo at switch 5 on the DVC.
DVC DAA DOWNLOADING	A DAA download is in progress.	No action is required.
DVC DATABASE CORRUPT	The database that houses the DVC's programming is corrupt.	The database must be re-downloaded, or all programming must be cleared and re-entered. If the trouble still does not clear, contact Technical Services.
DVC DBASE INCOMPAT	The programming database version is not compatible with the application version.	The correct application or database version must be downloaded.

Table D.2 System Troubles

SYSTEM TROUBLES		
TROUBLE MESSAGE TYPE	TROUBLE DESCRIPTION	ACTION
DVC DVC AUX TROUBLE	This trouble is generated when the auxiliary input is supervised (as determined in VeriFire Tools programming) and no signal is coming from the input.	Check the wiring and source.
DVC EXT RAM ERROR	The external RAM test failed.	Service is required.
DVC FFT TROUBLE	There is a short or open on the FFT riser.	Check that the 4-wire switch is correctly set and that there is an end-of-line resistor in place for 2-wire operation. Investigate for a break or short on the wiring.
DVC FLASH IMAGE ERR	The DVC software is corrupt.	Re-download the panel code software from VeriFire tools. If the trouble still does not clear, call Technical Services.
DVC LOADING NO SERV	A program or database download is in progress. The panel is NOT providing fire protection during the download.	Proper authorities should be notified while a download is in progress so that other means of fire protection can be supplied.
DVC LOCAL MIC. TBL	The local microphone is in trouble. There is no communication, or paging has been enabled for over 28 seconds and no signal has been received.	Investigate whether the mic is plugged into the DVC or whether there is a problem with the local mic.
DVC LOCAL PHONE TBL	The local FFT handset is in trouble. There is no communication, or paging has been enabled for over 28 seconds and no signal has been received.	Investigate whether the handset is plugged into the DVC or whether there is a problem with the local handset.
DVC NVRAM BATT TBL	Battery backup and/or clock backup is low.	Replace the battery. Refer to the <i>DVC Series Manual</i> for replacement instructions.
DVC PROGRAM CORRUPT	The database that houses the DVC's programming is corrupt.	The database must be re-downloaded, or all programming must be cleared and re-entered. If the trouble still does not clear, contact Technical Services.
DVC REM. MIC. TBL	The remote microphone is in trouble. It is installed and supervised, but no signal is coming from it.	Check wiring and connections.
DVC SELF TEST FAIL	The diagnostic test failed on the DVC.	Reboot the unit. If the problem does not clear, call Technical Services.
DVC SOFT. MISMATCH	One or more DAL device has a software revision that does not match other DAL device software revisions.	Update the DAA software to match.
EPROM ERROR	The application and/or boot code is corrupt.	Service is required.
EXCEEDED CONN. LIMIT	More than two panels have been connected to a high-speed network communications module.	Remove extra panel(s).
EXTERNAL RAM ERROR	The external RAM test failed.	Service is required.
GROUND FAULT	A ground fault has occurred within the panel.	Locate the ground fault and repair.
GROUND FAULT LOOP <u>x</u>	There is a ground fault on loop <u>x</u> .	Locate the ground fault and repair.
HS-NCM SNIFFER ACTIV	The panel is in a diagnostic mode.	No action is required.
INTERNAL RAM ERROR	The internal RAM test failed.	Service is required.
LCD80 SUPERVISORY	Communication has been lost with the LCD-80.	Check connections to the LCD-80 Annunciator.
LOADING.NO SERVICE	A program or database download is in progress. The panel is NOT providing fire protection during the download.	Proper authorities should be notified while a download is in progress so that other means of fire protection can be supplied.
MASTER BOX TROUBLE	A TM-4 connected to a municipal box is in trouble.	Reset the master box.
MASTER BOX NO ANSWER	A TM-4 connected to a municipal box is not responding.	Determine whether the device is functional and connected properly.
NCM COMM FAILURE	Communication is lost between the CPU2-640 and the network communications module or DVC.	Check to see if the NUP cable is properly installed and the network communications module or DVC is functional.
NETWORK FAIL PORT <u>x</u>	Communication lost between NCM Port <u>x</u> and corresponding node.	Check wiring and verify the node is online.
NETWORK INCOMPATIBLE	The brand of this panel is incompatible with this network.	Verify all nodes are branded for the same OEM.
NFPA 24HR REMINDER	This message occurs every day at 11 AM if any troubles exist.	Resolve any troubles on the system.
NO DEV. INST ON L1	No devices are installed on the system.	Install SLC and run autoprogram.
PANEL DOOR OPEN	The panel door is open.	Close door.

Table D.2 System Troubles

SYSTEM TROUBLES		
TROUBLE MESSAGE TYPE	TROUBLE DESCRIPTION	ACTION
POWER SUPPLY COMM FAIL	There has been a communication failure with the power supply.	Service is required.
PROGRAM CORRUPTED	The database that houses the panel's programming is corrupt.	The database must be re-downloaded, or all programming must be cleared and re-entered. If the trouble still does not clear, contact Technical Services.
PROGRAM MODE ACTIVATED	A user is currently accessing the panel's programming menus.	No action is required / Exit the Programming mode.
RELEASE DEV. DISABLE	Releasing devices have been disabled.	Enable the devices.
SELF TEST FAILED	Diagnostic test failed.	Call Technical Services.
STYLE 6 POS. LOOP $\underline{x}$	There is an open circuit on the positive side of loop $x$ . Style 6 and Style 7 are supervised methods of communicating with addressable devices. If the control panel detects a trouble (open), it will drive both ends of the loop, maintaining communication in an unsupervised method. The latching trouble will display on the panel as a Style 6 trouble until you correct the condition and press RESET. Style 7 configuration of the SLC requires the use of ISO-X isolator modules.	
STYLE 6 NEG. LOOP $\underline{x}$	There is an open circuit on the negative side of loop $\underline{x}$ . Style 6 and Style 7 are supervised methods of communicating with addressable devices. If the control panel detects a trouble (open), it will drive both ends of the loop, maintaining communication in an unsupervised method. The latching trouble will display on the panel as a Style 6 trouble until you correct the condition and press RESET. Style 7 configuration of the SLC requires the use of ISO-X isolator modules.	
STYLE 6 SHORT LOOP $\underline{x}$	Style 6 and Style 7 are supervised methods of communicating with addressable devices. If the control panel detects a trouble (open or short), it will drive both ends of the loop, maintaining communication in an unsupervised method. The latching trouble will display on the panel as a Style 6 trouble until you correct the condition and press RESET. Style 7 configuration of the SLC requires the use of ISO-X isolator modules.	
SYS INITIALIZATION	The devices are initializing.	No action is required, as the trouble will clear when initialization is completed. However, devices will not report off-normal events while this trouble exists.
TERM. SUPERVISORY	There is a communication error with the CRT-2.	Check connections to the CRT-2 terminal.
UDACT NO ANSWER	The UDACT or UDACT-2 is not responding.	Determine whether the UDACT/UDACT-2 is functional, and connected and addressed properly.
UDACT TROUBLE	The UDACT or UDACT-2 is in trouble.	Determine if the UDACT/UDACT-2 is functional and wired correctly.
* This trouble may be fire panel or backup battery related. Test and replace backup batteries if necessary/		

Table D.2 System Troubles

# Index

## A

Abort **53**  
Abort Active LED **12**  
Acknowledge/Scroll Display control key **12**  
Active Supervisory Signal **26–28**  
    panel indication **26**  
    response to **27**  
    Type Codes **27**  
Alarm Verification Timer **36, 62**  
Alarm. See Fire Alarm **17, 31**  
Analog Display **62**  
Annunciator Selections, read status **45**  
Auto Silence Timer **36**  
Automatic Test Operation **62**

## B

Battery Levels, read status **48**

## C

Caution  
    Disabling a zone disables all input and output... **30**  
CO Alarm **31–32**  
    panel indication **31**  
Coding  
    to view F8 selections **58**  
Coding, NAC **58**  
Control Keys **12**  
Control/Relay Module Trouble  
    panel indication **35**  
    response to **35**  
    Type Codes **34**  
Control/Relay Module, read status **41**  
Controls Active LED **11**  
Cooperative Multi-Detector, read status **41**  
Cross Zone **53**  
Cross Zone Programming illustration **55**  
CRT-2 and Read Status **66**  
    Accessing **66**  
CRT-2 and Read Status. See Appendix C

## D

Date Functions **56**  
Day/Night Sensitivity Operation **62**  
Delay Timer **53**  
Detector  
    fire alarm type codes **19, 32**  
    Functions **62**  
    Read Status **41**  
    supervisory alarm type codes **28**  
Disabled Points **30**

Discharge LED **12**  
Drill control key **13**

## F

Fire Alarm **17–18**  
    LED **12**  
    panel indication **17**  
    response to a **18, 32, 59**  
Fire Control Type Code, active point **31**

## H

Hidden History, read status and print **52**  
History, event and alarm, read status **49**  
Holiday Functions **56**  
    to view selections **57**

## I

Increment Number key **14**  
ISO-X module **37, 75**

## L

Lamp Test control key **14**  
Latching Supervisory Type Code **27**  
Latching/non-latching type codes. See particular type code for definition.  
LED Control Operation **62**  
LEDs, table of **11**  
Local Control setting and control keys **12**  
LocM (Local Monitor) **64, 65**  
LocT (Local Terminal Mode) **64**

## M

Maintenance Alert **62**  
Manual Release **53**  
Mass Notification **20–23**  
MN Alarm  
    panel indication **20**  
    response to a **20**  
MN Supervisory  
    panel indication **21**  
    response to a **21**  
MN Trouble  
    panel indication **22**  
    response to a **22**  
Monitor Module  
    fire alarm type codes **18, 23, 32**  
    non-alarm type codes **30**  
    Read Status **41**  
    security type codes **26**  
    supervisory alarm type codes **28**

trouble monitor type codes **33**

## N

NAC Trouble  
 panel indication **35**  
 response to **35**  
 Type Codes **34**  
 NAC, read status **42**  
 Non-Alarm Points **30**  
 Non-Fire Point, active, panel indication **31**  
 Non-latching Supervisory Type Code **27**  
 Normal Mode of Operation **17**

## O

Output Circuit Trouble **34–36**

## P

Partial Signal Silence **13**  
 Point (Device) Troubles table **72**  
 Point Disabled LED **12**  
 Power LED **11**  
 Pre-alarm LED **12**  
 Pre-Alarm Warning **28, 33**  
 action level **29**  
 alert level **29**  
 panel indication **28**  
 response to **29**  
 Pre-Discharge LED **11**  
 Presignal and Positive Alarm Sequence (PAS)  
 response to Presignal Delay Timer alarm  
 (no PAS) **60**  
 response to Presignal Delay Timer alarm  
 (PAS selected) **61**  
 to view selections **60**

## R

Read Status **38–52**  
 to enter **38**  
 to print **50**  
 alarm history **51**  
 event history **51**  
 points **50**  
 print hidden event and alarm history  
**52**  
 print points **51**  
 to view **39**  
 annunciator selections **45**  
 battery levels **48**  
 detector information **40**  
 devices, zones, system settings **39**  
 event and alarm history **49**  
 point or zone information **40**  
 Releasing Zone (R0-R9) **44**  
 releasing zone selections

software zones **43**  
 Special Zone (F0-F9) **43**  
 System Functions **44**  
 total of installed devices **40**  
 using a CRT. See Appendix C

Recall Last Entry key **14**  
 Releasing Zone (R0-R9), read status **44**  
 Releasing Zones (R0-R9) **53–55**  
 Remote Terminal Access **64–71**  
 RemT, Remote Terminal Mode **64, 65**

## S

Security Alarm **25**  
 panel indication **25**  
 response to a **25**  
 Security LED **12**  
 Sensitivity Adjust **62**  
 Shortcuts to Operating Functions **10**  
 Signal Silence control key **13**  
 Signals Silenced LED **12**  
 Silence Inhibit Timer **36, 37**  
 Soak Timer **53**  
 Software Zone (Z01-Z99), read status **43**  
 Special Zone Operation **53–61**  
 Special Zone, read status **43**  
 Supervisory LED **12**  
 Supplemental Documentation **9**  
 System Functions, read status **44**  
 System Normal Message **17**  
 System Reset control key **13**  
 System Timers **36**  
 Alarm Verification Timer **36**  
 Auto Silence Timer **36**  
 Silence Inhibit Timer **36, 37**  
 to view selections **36**  
 System Trouble **23–24**  
 panel indication **23**  
 response to **24**  
 System Trouble LED **12**  
 System Troubles **73**

## T

Time Functions **56**  
 to view selections **56**  
 Timers. See System Timers **36**  
 Transponder Points **34**  
 Trouble Monitor **33**  
 response to **33**  
 trouble monitor type codes **33**  
 Troubles  
 Point **72**  
 System **73**  
 Type Code Supervision **62**  
 Type Codes  
 Fire Alarm **18, 32**  
 Mass Notification **23**

Non-alarm **30**  
Security **26**  
Supervisory **28**  
Trouble **33**

## **W**

Warning

When used for CO2 releasing applica-  
tions... **16, 53**

Waterflow Circuit operation **37**

## **X**

XP6-C **34**

XPC transponder points **34**

## Manufacturer Warranties and Limitation of Liability

**Manufacturer Warranties.** Subject to the limitations set forth herein, Manufacturer warrants that the Products manufactured by it in its Northford, Connecticut facility and sold by it to its authorized Distributors shall be free, under normal use and service, from defects in material and workmanship for a period of thirty six months (36) months from the date of manufacture (effective Jan. 1, 2009). The Products manufactured and sold by Manufacturer are date stamped at the time of production. Manufacturer does not warrant Products that are not manufactured by it in its Northford, Connecticut facility but assigns to its Distributor, to the extent possible, any warranty offered by the manufacturer of such product. This warranty shall be void if a Product is altered, serviced or repaired by anyone other than Manufacturer or its authorized Distributors. This warranty shall also be void if there is a failure to maintain the Products and the systems in which they operate in proper working conditions.

MANUFACTURER MAKES NO FURTHER WARRANTIES, AND DISCLAIMS ANY AND ALL OTHER WARRANTIES, EITHER EXPRESSED OR IMPLIED, WITH RESPECT TO THE PRODUCTS, TRADEMARKS, PROGRAMS AND SERVICES RENDERED BY MANUFACTURER INCLUDING WITHOUT LIMITATION, INFRINGEMENT, TITLE, MERCHANTABILITY, OR FITNESS FOR ANY PARTICULAR PURPOSE. MANUFACTURER SHALL NOT BE LIABLE FOR ANY PERSONAL INJURY OR DEATH WHICH MAY ARISE IN THE COURSE OF, OR AS A RESULT OF, PERSONAL, COMMERCIAL OR INDUSTRIAL USES OF ITS PRODUCTS.

This document constitutes the only warranty made by Manufacturer with respect to its products and replaces all previous warranties and is the only warranty made by Manufacturer. No increase or alteration, written or verbal, of the obligation of this warranty is authorized. Manufacturer does not represent that its products will prevent any loss by fire or otherwise.

**Warranty Claims.** Manufacturer shall replace or repair, at Manufacturer's discretion, each part returned by its authorized Distributor and acknowledged by Manufacturer to be defective, provided that such part shall have been returned to Manufacturer with all charges prepaid and the authorized Distributor has completed Manufacturer's Return Material Authorization form. The replacement part shall come from Manufacturer's stock and may be new or refurbished. THE FOREGOING IS DISTRIBUTOR'S SOLE AND EXCLUSIVE REMEDY IN THE EVENT OF A WARRANTY CLAIM.

Warn-HL-08-2009.fm

 **NOTIFIER**<sup>®</sup>  
by Honeywell

World Headquarters  
12 Clintonville Road  
Northford, CT 06472-1610 USA  
203-484-7161  
fax 203-484-7118

[www.notifier.com](http://www.notifier.com)

**NATURSONNE**  
[www.natursonne.com.ar](http://www.natursonne.com.ar)



Pacheco 2060, CABA,  
Buenos Aires, Argentina  
Teléfono +54 11 4524-2655

**ISO 9001**  
**CERTIFIED**  
ENGINEERING & MANUFACTURING  
QUALITY SYSTEMS